

ENERO 2010

INDICE

SUSPENSION.....	3
PLAFÓN.....	31
PARED.....	43
MESA.....	59
PIE.....	71
PESOS Y VOLUMENES.....	84
FICHA TÉCNICA ILUMINACIÓN.....	86

NOMBRE PRODUCTO

NOTTE S7

MENGOTTI/PRANDINA, 2003-2006

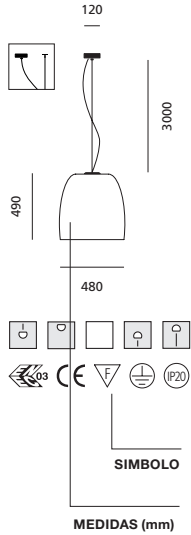

VERSIONES POSIBLES

CODIGOS

difusor	cromado	níquel cepillado	
CRISTAL BLANCO OPAL	1283000610101	1283000610201	720,00
CRISTAL NEGRO / INTERIOR PINTADO BLANCO	1283000610124	1283000610224	935,00
CRISTAL NEGRO / INTERIOR ORO	1283000610159	1283000610259	975,00
ESPEJO / INTERIOR PINTADO BLANCO	1283000610110	1283000610210	975,00
ESPEJO / INTERIOR PINTADO AMARILLO	1283000610111	1283000610211	975,00
OPCIONAL - punto de luz desplazado	6993600410100	6993600410200	90,00

- MAX 1x150W IAA/F E27
- MAX 1x150W HSGST/F E27
- 1x23W FBT E27
- MAX 1x100W HAGS/UB E27
- MAX 1x100W IRR E27

BOMBILLA ADMITIDA

SIMBOLOS

TODAS LAS LAMPARAS ESTÁN IDENTIFICADAS CON ETIQUETA, VOLTAGE Y FRECUENCIA, AISLAMIENTO Y CON EL TIPO DE BOMBILLA Y VATIOS LIMITADO. CADA LAMPARA SE SUMINISTRA CON INSTRUCCIONES PARA SU INSTALACIÓN Y USO. **SI LA LAMPARA SE INSTALA O USA INCORRECTAMENTE, LA GARANTIA NO ES VALIDA.**



TECHO



CLASE I. AISLAMIENTO SIMPLE:
SE REQUIERE TOMA DE TIERRA



APROVADA POR LAS NORMAS DE SEGURIDAD
DE LA COMUNIDAD EUROPEA



MESA



CLASE II. DOBLE AISLAMIENTO:
NO SE REQUIERE TOMA DE TIERRA



CERTIFICACION DE CONFORMIDAD EUROPEA



SUSPENSION



INDICE DE PROTECCION



LARGO UTIL DEL CABLE
CON TOMA BIPOLAR



PARED



PREPARADO PARA MONTAJES
NORMALMENTE INFLAMABLES



PIE

INFORMACIONES

PRANDINA TRABAJA CON LA MÁXIMA CALIDAD EN SUS PRODUCTOS, USANDO MATERIALES Y PERSONAL DE CALIDAD. ES IMPORTANTE RESEÑAR QUE ALGUNAS PIEZAS PUEDEN TENER DIFERENCIAS DE COLOR CON RESPECTO A OTRAS YA QUE SE TRATA DE CRISTALES HECHOS A MANO. ESTAS DIFERENCIAS NO SON IMPERFECCIONES: SON UNA GARANTIA QUE SON CRISTALES ARTESANALES. PRANDINA ESTÁ TRABAJANDO CONSTANTEMENTE PARA MEJORAR SUS PRODUCTOS Y SE RESERVA EL DERECHO A REALIZAR MODIFICACIONES SIN PREVIO AVISO.

SUSPENSION

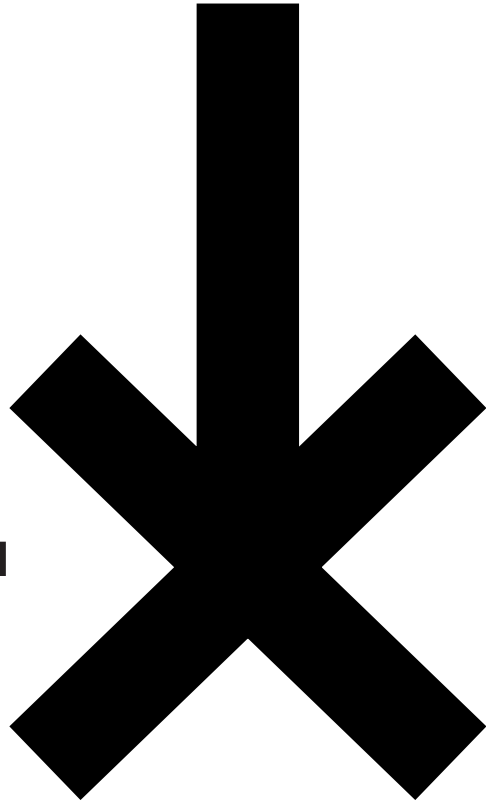

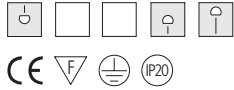
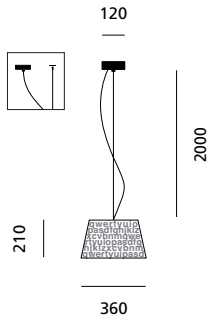

ABC S1

SANDRO SANTANTONIO DESIGN, 2007



<i>difusor</i>	<i>cromado</i>	<i>blanco mate</i>	
CRISTAL TRANSPARENTE + FILTRO BLANCO	1753000110120	1753000113020	804,00
CRISTAL BLANCO OPAL + FILTRO BLANCO	1753000110101	1753000113001	837,00
CRISTAL NEGRO + FILTRO BLANCO	1753000110105	—	881,00
OPCIONAL - punto de luz desplazado	6993600310100	6993600313000	46,00



MAX 1x150W IAA/F E27 
 MAX 1x150W HSGST/F E27 

ABC S11

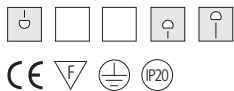
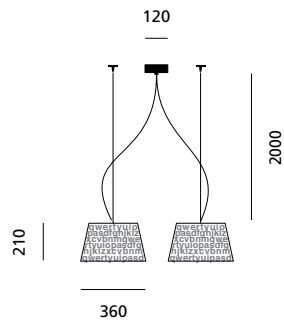
SANDRO SANTANTONIO DESIGN, 2007



<i>difusor</i>	<i>cromado</i>	<i>blanco mate</i>	
CRISTAL TRANSPARENTE + FILTRO BLANCO	1753000210120	1753000213020	1541,00
CRISTAL BLANCO OPAL + FILTRO BLANCO	1753000210101	1753000213001	1662,00
CRISTAL NEGRO + FILTRO BLANCO	1753000210105	—	1740,00



MAX 2x150W IAA/F E27 
 MAX 2x150W HSGST/F E27 

ABC S3

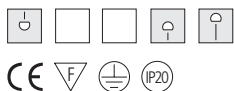
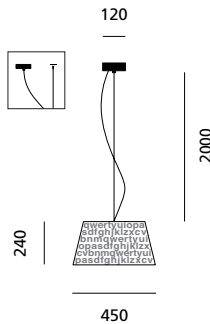
SANDRO SANTANTONIO DESIGN, 2007



<i>difusor</i>	<i>cromado</i>	<i>blanco mate</i>	
CRISTAL TRANSPARENTE + FILTRO BLANCO	1753000310120	1753000313020	1065,00
CRISTAL BLANCO OPAL + FILTRO BLANCO	1753000310101	1753000313001	1153,00
CRISTAL NEGRO + FILTRO BLANCO	1753000310105	—	1209,00
OPCIONAL - punto de luz desplazado	6993600310100	6993600313000	46,00

MAX 1x150W IAA/F E27 
 MAX 1x150W HSGST/F E27 

ABC S5

SANDRO SANTANTONIO DESIGN, 2007

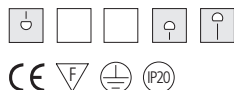
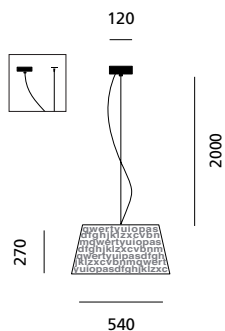

<i>difusor</i>	<i>cromado</i>	<i>blanco mate</i>	
CRISTAL TRANSPARENTE + FILTRO BLANCO	1753000410120	1753000413020	1707,00
CRISTAL BLANCO OPAL + FILTRO BLANCO	1753000410101	1753000413001	1784,00
CRISTAL NEGRO + FILTRO BLANCO	1753000410105	—	1851,00
OPCIONAL - punto de luz desplazado	6993600410100	6993600413000	99,00

MAX 1x150W IAA/F E27
MAX 1x150W HSGST/F E27

BILUNA S7

LUC RAMAEL, 2007

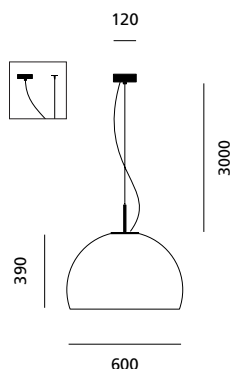

PP <i>polipropileno difusor</i>	<i>blanco mate</i>	
NEGRO MATE	1873000113500	1122,00

<i>difusor en polipropileno barnizado</i>	<i>blanco mate</i>	
BLANCO BRILLANTE	1763000114500	1442,00
NEGRO BRILLANTE	1763000114600	1442,00
NEGRO MATE	1763000113500	1442,00
BEIGE MATE	1763000114400	1442,00
OPCIONAL - punto de luz desplazado	6993600413000	99,00

1x55W FSC 2GX13

BILUNA S7 DIMM

LUC RAMAEL, 2007

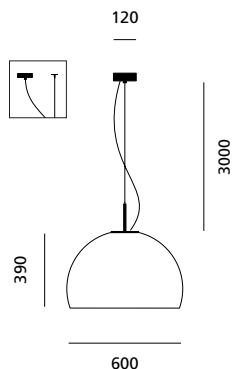

PP <i>polipropileno difusor</i>	<i>blanco mate</i>	
NEGRO MATE	1873000213500	1299,00

<i>difusor en polipropileno barnizado</i>	<i>blanco mate</i>	
BLANCO BRILLANTE	1763000214500	1630,00
NEGRO BRILLANTE	1763000214600	1630,00
NEGRO MATE	1763000213500	1630,00
BEIGE MATE	1763000214400	1630,00
OPCIONAL - punto de luz desplazado	6993601013000	99,00

1x55W FSC 2GX13

!! VERIFICAR QUE EL SISTEMA ELECTRICO PUEDA SOPORTAR UN DIMMER DIGITAL !!

BILUNA S9

LUC RAMAEL, 2007

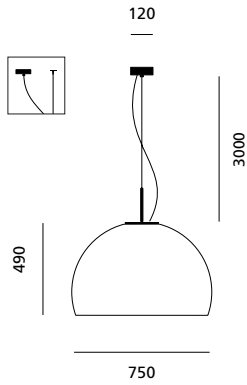

polipropileno difusor

blanco mate

NEGRO MATE	1873000313500	1421,00
------------	---------------	---------

difusor en polipropileno barnizado

blanco mate

BLANCO BRILLANTE	1763000314500	1752,00
NEGRO BRILLANTE	1763000314600	1752,00
NEGRO MATE	1763000313500	1752,00
BEIGE MATE	1763000314400	1752,00

OPCIONAL - punto de luz desplazado	6993600413000	99,00
------------------------------------	---------------	-------

1x55W FSC 2GX13



BILUNA S9 DIMM

LUC RAMAEL, 2007

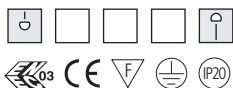
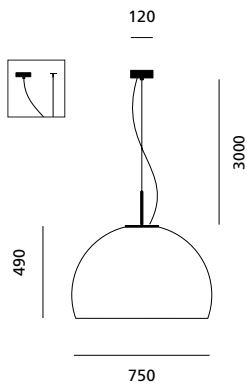

polipropileno difusor

blanco mate

NEGRO MATE	1873000413500	1531,00
------------	---------------	---------

difusor en polipropileno barnizado

blanco mate

BLANCO BRILLANTE	1763000414500	1863,00
NEGRO BRILLANTE	1763000414600	1863,00
NEGRO MATE	1763000413500	1863,00
BEIGE MATE	1763000414400	1863,00

OPCIONAL - punto de luz desplazado	6993601013000	99,00
------------------------------------	---------------	-------

1x55W FSC 2GX13



!! VERIFICAR QUE EL SISTEMA ELECTRICO PUEDA SOPORTAR UN DIMMER DIGITAL !!

BILUNA S90

LUC RAMAEL, 2009

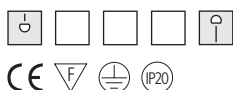
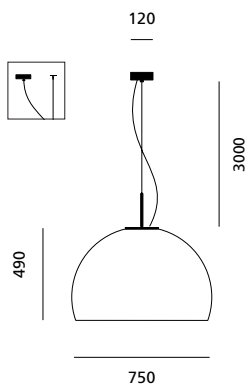

polipropileno difusor

blanco mate

NEGRO MATE	1873000513500	1587,00
------------	---------------	---------

OPCIONAL - punto de luz desplazado	6993600413000	99,00
------------------------------------	---------------	-------

2x42W FSMH GX24q-4



BILUNA S90 DIMM

LUC RAMAEL, 2009

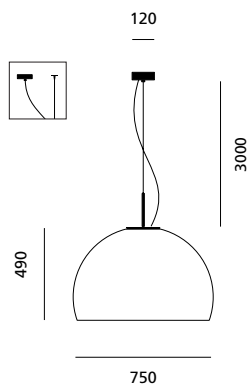

polipropileno difusor

blanco mate

NEGRO MATE	1873000613500	1752,00
OPCIONAL - punto de luz desplazado	6993601013000	99,00



2x42W FSMH GX24q-4

!! VERIFICAR QUE EL SISTEMA ELECTRICO PUEDA SOPORTAR UN DIMMER DIGITAL !!



CPL S1

CHRISTIAN PLODERER, 1998-2000

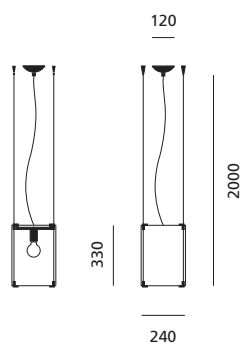

difusor

cromado

niquel cepillado

CRISTAL BLANCO OPAL	1083000110101	1083000110201	635,00
CRISTAL TRANSPARENTE	1083000110120	1083000110220	657,00

CRISTAL TRANSPARENTE MAX 1x150W IAA/F E27
 MAX 1x150W IAA/C E27
 MAX 1x100W HAGS/UB E27
 MAX 1x150W IRR E27

CRISTAL OPAL MAX 1x150W IAA/F E27
 MAX 1x23W FBG E27

CPL S11

CHRISTIAN PLODERER, 1998-2000

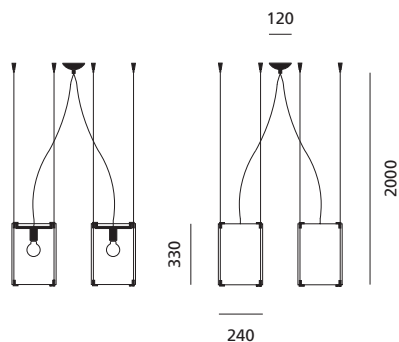

difusor

cromado

niquel cepillado

CRISTAL BLANCO OPAL	1083000210101	1083000210201	1170,00
CRISTAL TRANSPARENTE	1083000210120	1083000210220	1226,00

CRISTAL TRANSPARENTE MAX 2x150W IAA/F E27
 MAX 2x150W IAA/C E27
 MAX 2x100W HAGS/UB E27
 MAX 2x150W IRR E27

CRISTAL OPAL MAX 2x150W IAA/F E27
 MAX 2x23W FBG E27

CPL S3

CHRISTIAN PLODERER, 1998

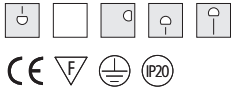
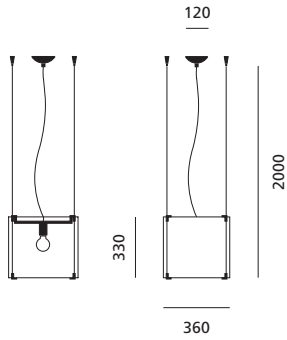

difusor	cromado	níquel cepillado	
CRISTAL BLANCO OPAL	1083000310101	1083000310201	750,00
CRISTAL TRANSPARENTE	1083000310120	1083000310220	750,00

CRISTAL TRANSPARENTE	MAX 1x150W IAA/F E27		CRISTAL OPAL	MAX 1x150W IAA/F E27	
	MAX 1x150W IAA/C E27			MAX 1x23W FBG E27	
	MAX 1x100W HAGS/UB E27				
	MAX 1x150W IRR E27				

CPL S5

CHRISTIAN PLODERER, 1998

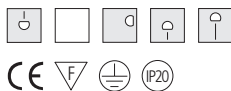
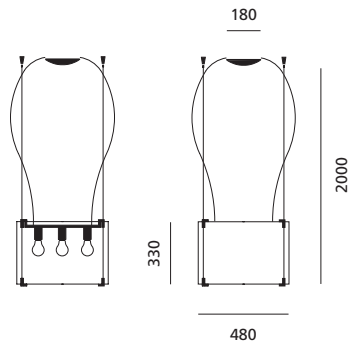

difusor	cromado	níquel cepillado	
CRISTAL BLANCO OPAL	1083000410101	1083000410201	1512,00
CRISTAL TRANSPARENTE	1083000410120	1083000410220	1512,00

CRISTAL TRANSPARENTE	MAX 3x100W IAA/C E27		CRISTAL OPAL	MAX 3x100W IAA/F E27	
	MAX 3x100W IAA/F E27				

CPL S7

CHRISTIAN PLODERER, 2003

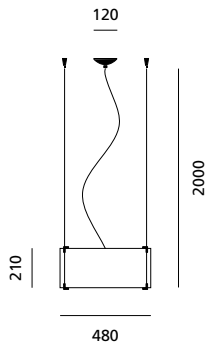

difusor	cromado	níquel cepillado	
CRISTAL BLANCO OPAL	1083000510101	1083000510201	944,00
CRISTAL NEGRO OPAL	1083000510105	1083000510205	1032,00
CRISTAL ROJO OPAL	1083000510106	1083000510206	1076,00
ESPEJO	1083000510107	1083000510207	1164,00

MAX 3x60W IAA/F E27	
---------------------	--

EQUILIBRE HALO S3

LUC RAMAEL, 2009

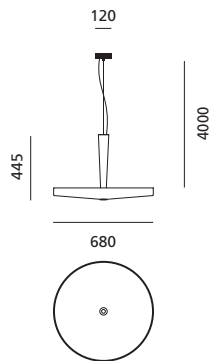

difusor

ALUMINIO PINTADO BLANCO	1133000113000	1232,00
ALUMINIO PINTADO GRIS	1133000113300	1232,00
OPCIONAL - minispot		20,00

MAX 3x150W HDG R7s  + MAX 1x40W HMGS/UB G9 

EQUILIBRE FLUO S3

LUC RAMAEL, 2006

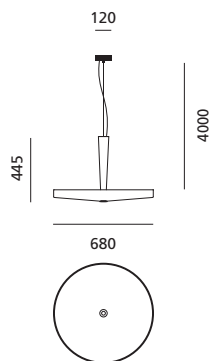

difusor

ALUMINIO PINTADO BLANCO	1513000513000	1430,00
ALUMINIO PINTADO GRIS	1513000513300	1430,00
OPCIONAL - minispot		20,00

4x36W FSD 2G11  + MAX 1x40W HMGS/UB G9 

EQUILIBRE FLUO S3 DIMM

LUC RAMAEL, 2006

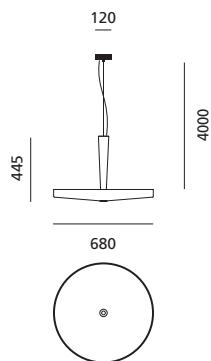

difusor

ALUMINIO PINTADO BLANCO	1513000713000	1673,00
ALUMINIO PINTADO GRIS	1513000713300	1673,00
OPCIONAL - minispot		20,00

4x36W FSD 2G11  + MAX 1x40W HMGS/UB G9 

!! VERIFICAR QUE EL SISTEMA ELECTRICO PUEDA SOPORTAR UN DIMMER DIGITAL !!

EQUILIBRE FLUO S30

LUC RAMAEL, 2010

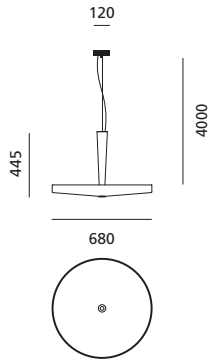

difusor en plexiglas®

BLANCO	1513000913001	1232,00
--------	---------------	---------



1x22W FSC 2GX13 + 1x40W FSC 2GX13



EXTRA S1

MENGOTTI/PRANDINA, 1994

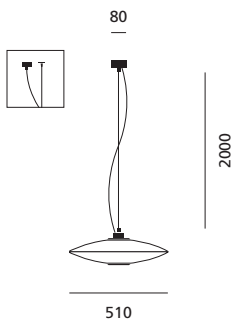

difusor

cromado

níquel cepillado

difusor	cromado	níquel cepillado	
CRISTAL BLANCO + FILTRO BLANCO	1143000110101	1143000110201	514,00
CRISTAL BLANCO / ESPEJO + FILTRO BLANCO	1143000110107	1143000110207	635,00
OPCIONAL - punto de luz desplazado	6993600210100	6993600210200	46,00



MAX 1x100W IAA/F E27



MAX 1x250W HSGST/F E27



EXTRA S3

MENGOTTI/PRANDINA, 1994

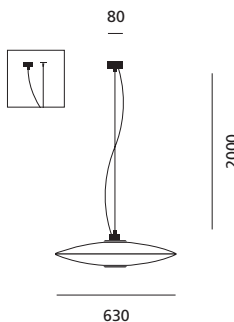

difusor

cromado

níquel cepillado

difusor	cromado	níquel cepillado	
CRISTAL BLANCO + FILTRO BLANCO	1143000310101	1143000310201	541,00
CRISTAL BLANCO / ESPEJO + FILTRO BLANCO	1143000310107	1143000310207	674,00
OPCIONAL - punto de luz desplazado	6993600210100	6993600210200	46,00



MAX 1x100W IAA/F E27



MAX 1x250W HSGST/F E27



GINGER S3

UFFICIO TECNICO PRANDINA/AZZOLIN, 2009

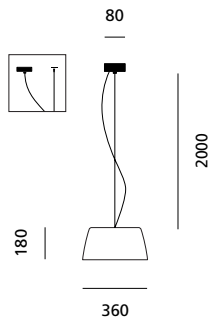

difusor

blanco mate

BLANCO OPAL PLEXIGLAS®	1903000113001	359,00
OPCIONAL - punto de luz desplazado	6993600113000	46,00



MAX 2x60W HSGST/F G9 



GINGER S30

UFFICIO TECNICO PRANDINA/AZZOLIN, 2010

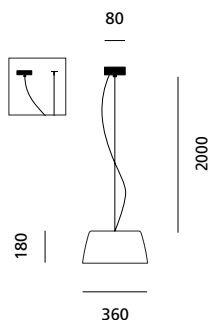

difusor

blanco mate

BLANCO OPAL PLEXIGLAS®	1903000713001	359,00
OPCIONAL - punto de luz desplazado	6993600113000	46,00



MAX 2x12W FBG E27 



GINGER S5

UFFICIO TECNICO PRANDINA/AZZOLIN, 2009

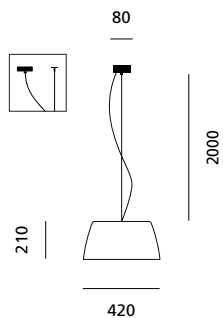

difusor

blanco mate

BLANCO OPAL PLEXIGLAS®	1903000513001	427,00
OPCIONAL - punto de luz desplazado	6993600113000	46,00



MAX 2x75W HSGST/F G9 



GINGER S50

UFFICIO TECNICO PRANDINA/AZZOLIN, 2010

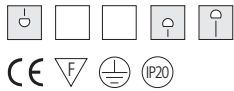
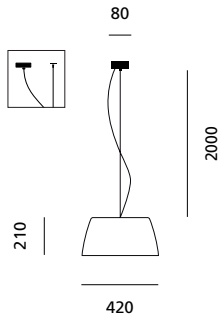

difusor

blanco mate

BLANCO OPAL PLEXIGLAS®	1903000813001	427,00
OPCIONAL - punto de luz desplazado	6993600113000	46,00

MAX 2x12W FBG E27 

GINGER S7

UFFICIO TECNICO PRANDINA/AZZOLIN, 2009

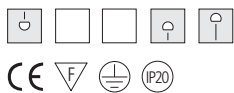
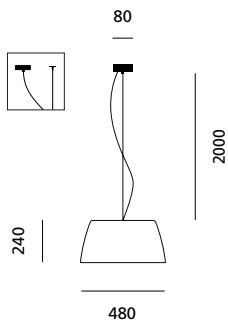

difusor

blanco mate

BLANCO OPAL PLEXIGLAS®	1903000213001	509,00
OPCIONAL - punto de luz desplazado	6993600113000	46,00

MAX 2x75W HSGST/F G9 

GINGER S70

UFFICIO TECNICO PRANDINA/AZZOLIN, 2010

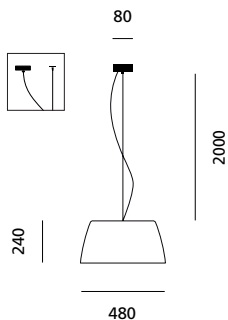

difusor

blanco mate

BLANCO OPAL PLEXIGLAS®	1903000913001	509,00
OPCIONAL - punto de luz desplazado	6993600113000	46,00

MAX 2x12W FBG E27 

GURU S3

P.KRISTIAN PETTERSEN, 2009

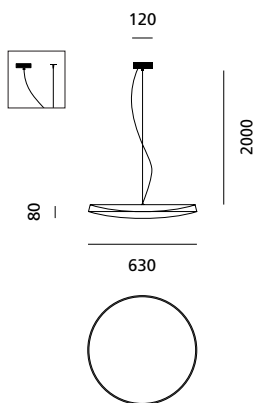

cuerpo en poliuretano barnizado

blanco mate

BLANCO MATE	1923000113001	672,00
BLANCO BRILLANTE	1923000114501	672,00
OPCIONAL - punto de luz desplazado	6993600313000	46,00

1x55W FSC 2GX13



GURU S3 DIMM

P.KRISTIAN PETTERSEN, 2009

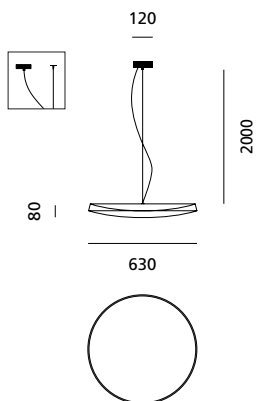

cuerpo en poliuretano barnizado

blanco mate

BLANCO MATE	1923000213001	760,00
BLANCO BRILLANTE	1923000214501	760,00
OPCIONAL - punto de luz desplazado	6993601113000	46,00

1x55W FSC 2GX13



!! VERIFICAR QUE EL SISTEMA ELECTRICO PUEDA SOPORTAR UN DIMMER DIGITAL !!

LIGHT VOLUME 33S

BAKERYGROUP, 2000

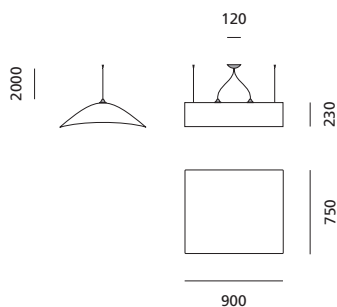

difusor

blanco mate

TELA BLANCA	1223000110001	687,00
-------------	---------------	---------------

MAX 2x100W IAA/F E27



MAX 2x24W FBC E27



LIGHT VOLUME FLUO 33S

BAKERYGROUP, 2004

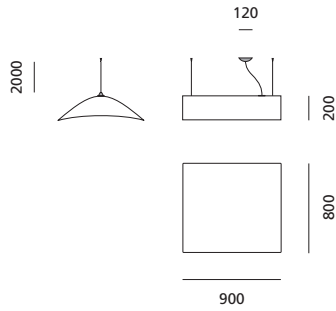

difusor

blanco mate

TELA BLANCA	1463000110001	786,00
OPCIONAL - versión fluorescente dimerable	1463000710001	963,00



1x55W FSDH 2G11 

!! VERIFICAR QUE EL SISTEMA ELECTRICO PUEDA SOPORTAR UN DIMMER DIGITAL !!



LIGHT VOLUME FLUO 34S

BAKERYGROUP, 2004

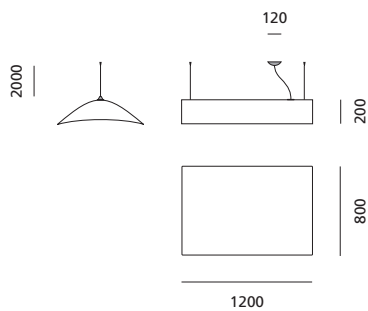

difusor

blanco mate

TELA BLANCA	1463000210001	887,00
OPCIONAL - versión fluorescente dimerable	1463000810001	1041,00



1x80W FSDH 2G11 

!! VERIFICAR QUE EL SISTEMA ELECTRICO PUEDA SOPORTAR UN DIMMER DIGITAL !!



LIGHT VOLUME FLUO 34S6

BAKERYGROUP, 2004

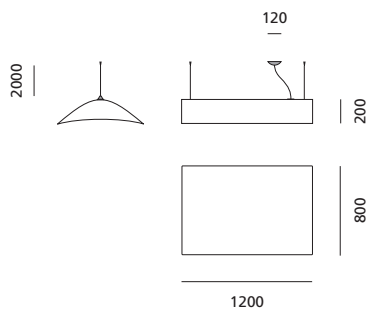

difusor

blanco mate

TELA BLANCA	1463000310001	920,00
OPCIONAL - versión fluorescente dimerable	1463000910001	1085,00



2x55W FSDH 2G11 

!! VERIFICAR QUE EL SISTEMA ELECTRICO PUEDA SOPORTAR UN DIMMER DIGITAL !!



NOTTE S1

MENGOTTI/PRANDINA, 2009

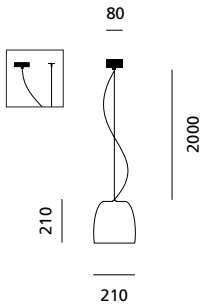

difusor en metal barnizado

cromado

níquel cepillado

BLANCO / INTERIOR PINTADO BLANCO	1843000510101	1843000510201	224,00
NEGRO / INTERIOR PINTADO BLANCO	1843000510124	1843000510224	268,00
OPCIONAL - punto de luz desplazado	6993600110100	6993600110200	35,00



MAX 1x75W HSGST/F G9

NOTTE S11

MENGOTTI/PRANDINA, 2009

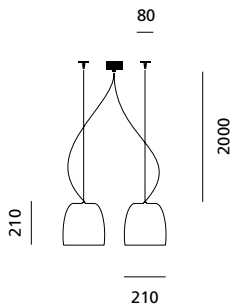

difusor en metal barnizado

cromado

níquel cepillado

BLANCO / INTERIOR PINTADO BLANCO	1843000610101	1843000610201	419,00
NEGRO / INTERIOR PINTADO BLANCO	1843000610124	1843000610224	501,00



MAX 2x75W HSGST/F G9

NOTTE S3

MENGOTTI/PRANDINA, 2003-2005

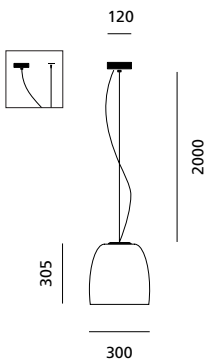

difusor

cromado

níquel cepillado

CRISTAL BLANCO OPAL	1283000110101	1283000110201	338,00
CRISTAL NEGRO / INTERIOR PINTADO BLANCO	1283000110124	1283000110224	437,00
CRISTAL NEGRO / INTERIOR ORO	1283000110159	1283000110259	476,00
ESPEJO / INTERIOR PINTADO BLANCO	1283000110110	1283000110210	476,00
ESPEJO / INTERIOR PINTADO AMARILLO	1283000110111	1283000110211	476,00
OPCIONAL - punto de luz desplazado	6993600310100	6993600310200	46,00



MAX 1x150W IAA/F E27

MAX 1x100W HGS/UB E27

MAX 1x150W HSGST/F E27

MAX 1x100W IRR E27

1x23W FBT E27

NOTTE S3

MENGOTTI/PRANDINA, 2008

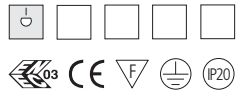
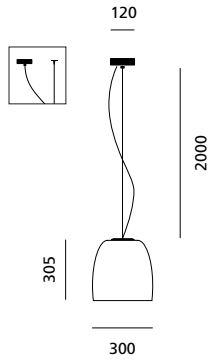

difusor en metal barnizado

cromado

níquel cepillado

BLANCO / INTERIOR PINTADO BLANCO	1843000110101	1843000110201	360,00
BLANCO / INTERIOR NARANJA (RAL 2000)	1843000110128	1843000110228	360,00
GRIS / INTERIOR PINTADO BLANCO	1843000110129	1843000110229	360,00
NEGRO / INTERIOR PINTADO BLANCO	1843000110124	1843000110224	360,00
OPCIONAL - punto de luz desplazado	6993600310100	6993600310200	46,00

MAX 1x150W IAA/F E27



MAX 1x100W HAGS/UB E27



MAX 1x150W HSGST/F E27



MAX 1x100W IRR E27



1x23W FBT E27



NOTTE S33

MENGOTTI/PRANDINA, 2003-2005

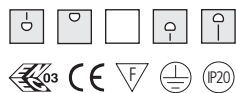
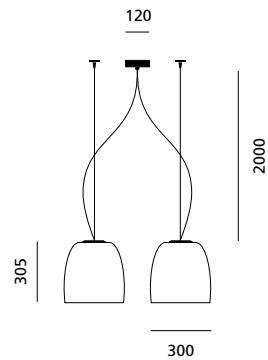

difusor

cromado

níquel cepillado

CRISTAL BLANCO OPAL	1283000510101	1283000510201	608,00
CRISTAL NEGRO / INTERIOR PINTADO BLANCO	1283000510124	1283000510224	840,00
CRISTAL NEGRO / INTERIOR ORO	1283000510159	1283000510259	906,00
ESPEJO / INTERIOR PINTADO BLANCO	1283000510110	1283000510210	906,00
ESPEJO / INTERIOR PINTADO AMARILLO	1283000510111	1283000510211	906,00

MAX 2x150W IAA/F E27



MAX 2x100W HAGS/UB E27



MAX 2x150W HSGST/F E27



MAX 2x100W IRR E27



2x23W FBT E27



NOTTE S33

MENGOTTI/PRANDINA, 2008

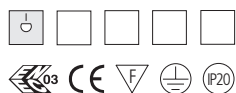
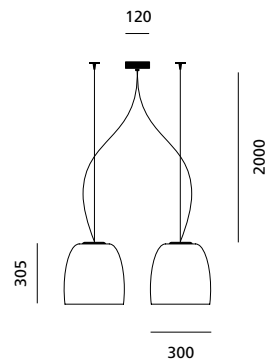

difusor en metal barnizado

cromado

níquel cepillado

BLANCO / INTERIOR PINTADO BLANCO	1843000310101	1843000310201	708,00
BLANCO / INTERIOR NARANJA (RAL 2000)	1843000310128	1843000310228	708,00
GRIS / INTERIOR PINTADO BLANCO	1843000310129	1843000310229	708,00
NEGRO / INTERIOR PINTADO BLANCO	1843000310124	1843000310224	708,00

MAX 2x150W IAA/F E27



MAX 2x100W HAGS/UB E27



MAX 2x150W HSGST/F E27



MAX 2x100W IRR E27



2x23W FBT E27



NOTTE S5

MENGOTTI/PRANDINA, 2003-2006

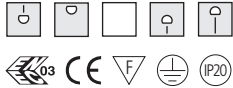
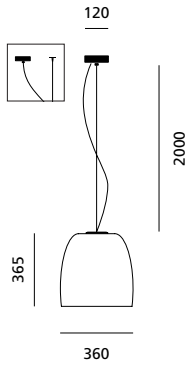

difusor

cromado

níquel cepillado

CRISTAL BLANCO OPAL	1283000310101	1283000310201	419,00
CRISTAL NEGRO / INTERIOR PINTADO BLANCO	1283000310124	1283000310224	562,00
CRISTAL NEGRO / INTERIOR ORO	1283000310159	1283000310259	595,00
ESPEJO / INTERIOR PINTADO BLANCO	1283000310110	1283000310210	595,00
ESPEJO / INTERIOR PINTADO AMARILLO	1283000310111	1283000310211	595,00
OPCIONAL - punto de luz desplazado	6993600310100	6993600310200	46,00

MAX 1x150W IAA/F E27



MAX 1x100W HAGS/UB E27



MAX 1x150W HSGST/F E27



MAX 1x100W IRR E27



1x23W FBT E27



NOTTE S5

MENGOTTI/PRANDINA, 2008

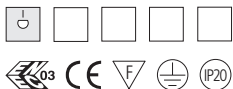
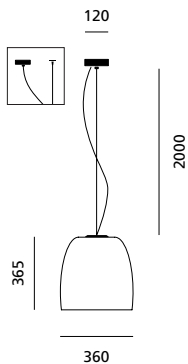

difusor en metal barnizado

cromado

níquel cepillado

BLANCO / INTERIOR PINTADO BLANCO	1843000210101	1843000210201	463,00
BLANCO / INTERIOR NARANJA (RAL 2000)	1843000210128	1843000210228	463,00
GRIS / INTERIOR PINTADO BLANCO	1843000210129	1843000210229	463,00
NEGRO / INTERIOR PINTADO BLANCO	1843000210124	1843000210224	463,00
OPCIONAL - punto de luz desplazado	6993600310100	6993600310200	46,00

MAX 1x150W IAA/F E27



MAX 1x100W HAGS/UB E27



MAX 1x150W HSGST/F E27



MAX 1x100W IRR E27



1x23W FBT E27



NOTTE FLUO S5

MENGOTTI/PRANDINA, 2003-2006

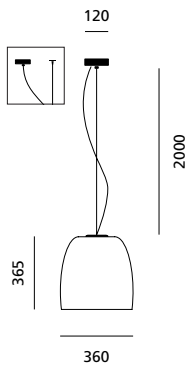

difusor

cromado

níquel cepillado

CRISTAL BLANCO OPAL	1623000110101	1623000110201	564,00
CRISTAL NEGRO / INTERIOR PINTADO BLANCO	1623000110124	1623000110224	730,00
CRISTAL NEGRO / INTERIOR ORO	1623000110159	1623000110259	763,00
ESPEJO / INTERIOR PINTADO BLANCO	1623000110110	1623000110210	763,00
ESPEJO / INTERIOR PINTADO AMARILLO	1623000110111	1623000110211	763,00
OPCIONAL - punto de luz desplazado	6993600310100	6993600310200	46,00

1x42W FSMH GX24q-4



FILTRO PYREX INCLUIDO

NOTTE FLUO S5

MENGOTTI/PRANDINA, 2008

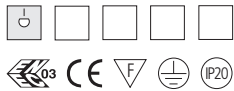
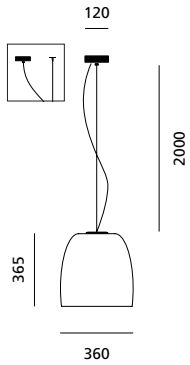

difusor en metal barnizado

cromado

níquel cepillado

BLANCO / INTERIOR PINTADO BLANCO	1853000110101	1853000110201	664,00
BLANCO / INTERIOR NARANJA (RAL 2000)	1853000110128	1853000110228	664,00
GRIS / INTERIOR PINTADO BLANCO	1853000110129	1853000110229	664,00
NEGRO / INTERIOR PINTADO BLANCO	1853000110124	1853000110224	664,00
OPCIONAL - punto de luz desplazado	6993600310100	6993600310200	46,00

1x42W FSMH GX24q-4

NOTTE S7

MENGOTTI/PRANDINA, 2003-2006

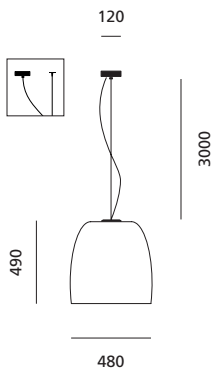

difusor

cromado

níquel cepillado

CRISTAL BLANCO OPAL	1283000610101	1283000610201	824,00
CRISTAL NEGRO / INTERIOR PINTADO BLANCO	1283000610124	1283000610224	1061,00
CRISTAL NEGRO / INTERIOR ORO	1283000610159	1283000610259	1105,00
ESPEJO / INTERIOR PINTADO BLANCO	1283000610110	1283000610210	1105,00
ESPEJO / INTERIOR PINTADO AMARILLO	1283000610111	1283000610211	1105,00
OPCIONAL - punto de luz desplazado	6993600410100	6993600410200	99,00

MAX 1x150W IAA/F E27

MAX 1x100W HAGS/UB E27

MAX 1x150W HSGST/F E27

MAX 1x100W IRR E27

1x23W FBT E27

NOTTE S7

MENGOTTI/PRANDINA, 2008

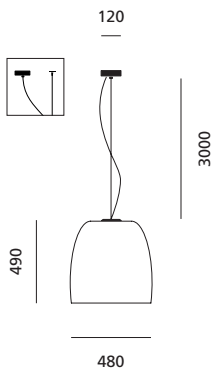

difusor en metal barnizado

cromado

níquel cepillado

BLANCO / INTERIOR PINTADO BLANCO	1843000410101	1843000410201	978,00
BLANCO / INTERIOR NARANJA (RAL 2000)	1843000410128	1843000410228	978,00
GRIS / INTERIOR PINTADO BLANCO	1843000410129	1843000410229	978,00
NEGRO / INTERIOR PINTADO BLANCO	1843000410124	1843000410224	978,00
OPCIONAL - punto de luz desplazado	6993600410100	6993600410200	99,00

MAX 1x150W IAA/F E27

MAX 1x100W HAGS/UB E27

MAX 1x150W HSGST/F E27

MAX 1x100W IRR E27

1x23W FBT E27

NOTTE FLUO S7

MENGOTTI/PRANDINA, 2003-2006

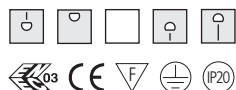
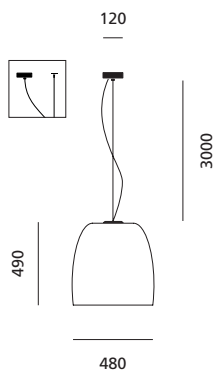

<i>difusor</i>	<i>cromado</i>	<i>níquel cepillado</i>	
CRISTAL BLANCO OPAL	1623000310101	1623000310201	989,00
CRISTAL NEGRO / INTERIOR PINTADO BLANCO	1623000310124	1623000310224	1221,00
CRISTAL NEGRO / INTERIOR ORO	1623000310159	1623000310259	1243,00
ESPEJO / INTERIOR PINTADO BLANCO	1623000310110	1623000310210	1243,00
ESPEJO / INTERIOR PINTADO AMARILLO	1623000310111	1623000310211	1243,00
OPCIONAL - punto de luz desplazado	6993600410100	6993600410200	99,00

MAX 2x42W FSMH GX24q-4

FILTRO PYREX INCLUIDO

NOTTE FLUO S7

MENGOTTI/PRANDINA, 2008

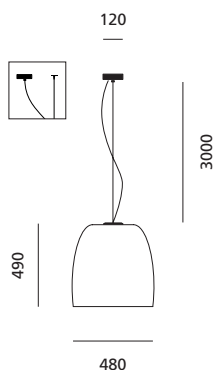

(MT)

<i>difusor en metal barnizado</i>	<i>cromado</i>	<i>níquel cepillado</i>	
BLANCO / INTERIOR PINTADO BLANCO	1853000310101	1853000310201	1243,00
BLANCO / INTERIOR NARANJA (RAL 2000)	1853000310128	1853000310228	1243,00
GRIS / INTERIOR PINTADO BLANCO	1853000310129	1853000310229	1243,00
NEGRO / INTERIOR PINTADO BLANCO	1853000310124	1853000310224	1243,00
OPCIONAL - punto de luz desplazado	6993600410100	6993600410200	99,00

MAX 2x42W FSMH GX24q-4

NOTTE FLUO S9

MENGOTTI/PRANDINA, 2003-2006

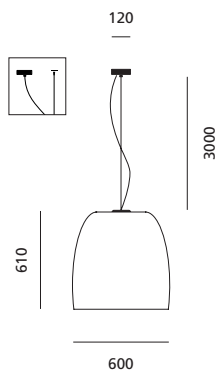

(PE)

<i>polietileno difusor</i>	<i>cromado</i>	<i>níquel cepillado</i>	
BLANCO MATE	1673000110101	1673000110201	886,00
NEGRO MATE / INTERIOR PINTADO BLANCO	1673000110124	1673000110224	1283,00
NEGRO BRILLANTE / INTERIOR PINTADO BLANCO	1673000110112	1673000110212	1283,00
OPCIONAL - punto de luz desplazado	6993600410100	6993600410200	146,00



MAX 2x42W FSMH GX24q-4

OVER S3

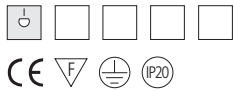
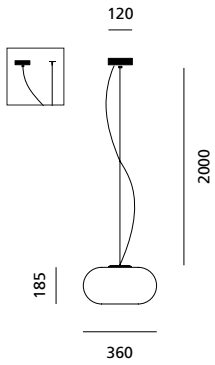
MENGOTTI/PRANDINA, 2003



<i>difusor</i>	<i>cromado</i>	<i>níquel cepillado</i>	
CRISTAL BLANCO OPAL	1303000110101	1303000110201	337,00
OPCIONAL - punto de luz desplazado	6993600310100	6993600310200	46,00



MAX 1x100W IAA/F E27 
 MAX 1x150W HSGST/F E27 

OVER S33

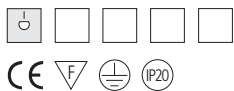
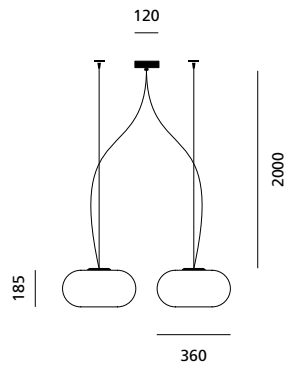
MENGOTTI/PRANDINA, 2003



<i>difusor</i>	<i>cromado</i>	<i>níquel cepillado</i>	
CRISTAL BLANCO OPAL	1303000510101	1303000510201	595,00



MAX 2x100W IAA/F E27 
 MAX 2x150W HSGST/F E27 

OVER S5

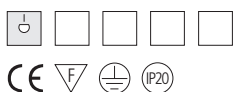
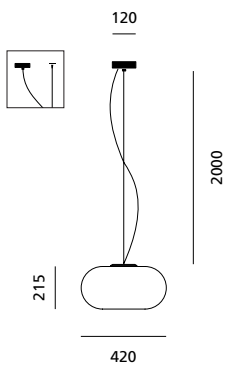
MENGOTTI/PRANDINA, 2003



<i>difusor</i>	<i>cromado</i>	<i>níquel cepillado</i>	
CRISTAL BLANCO OPAL	1303000310101	1303000310201	389,00
OPCIONAL - punto de luz desplazado	6993600310100	6993600310200	46,00

MAX 1x150W IAA/F E27 
 MAX 1x150W HSGST/F E27 

QUAD S1

MENGOTTI/PRANDINA, 1996

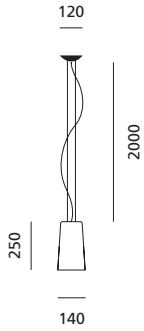

difusor

níquel cepillado

CRISTAL BLANCO OPAL	1313000110201	276,00
CRISTAL AMBAR OPAL	1313000110202	323,00
CRISTAL ROJO OPAL	1313000110206	323,00

MAX 1x100W IAA/F E27
1x23W FBT E27



QUAD S11

MENGOTTI/PRANDINA, 1996

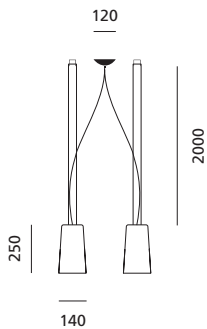

difusor

níquel cepillado

CRISTAL BLANCO OPAL	1313000210201	551,00
CRISTAL AMBAR OPAL	1313000210202	635,00
CRISTAL ROJO OPAL	1313000210206	635,00

MAX 2x100W IAA/F E27
2x23W FBT E27



QUAD S3

MENGOTTI/PRANDINA, 2000

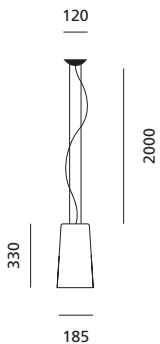

difusor

níquel cepillado

CRISTAL BLANCO OPAL	1313000310201	318,00
CRISTAL AMBAR OPAL	1313000310202	381,00
CRISTAL ROJO OPAL	1313000310206	381,00

MAX 1x100W IAA/F E27
1x23W FBT E27



QUAD S33

MENGOTTI/PRANDINA, 2000

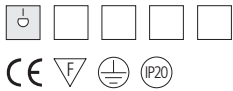
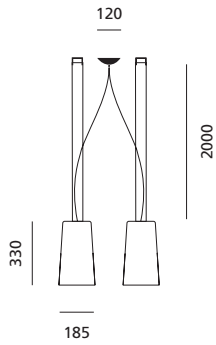

difusor

níquel cepillado

CRISTAL BLANCO OPAL	1313000410201	595,00
CRISTAL AMBAR OPAL	1313000410202	710,00
CRISTAL ROJO OPAL	1313000410206	710,00

MAX 2x100W IAA/F E27 
2x23W FBT E27 

ROOM FLUO S5

HETTLER/TÜLLMANN, 2009

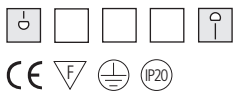
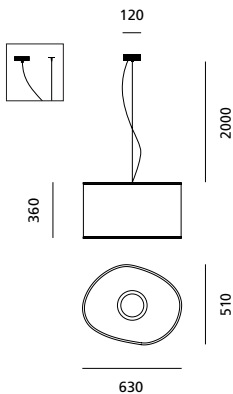

difusor

blanco mate

POLIETILENO BLANCO MATE / TELA CRUDO	1893000113034	671,00
POLIETILENO BLANCO MATE / SEDA PINTADA CRUDO	1893000113035	671,00
POLIETILENO BLANCO MATE / TELA NARANJA	1893000113036	671,00
POLIETILENO BLANCO MATE / SEDA PINTADA NARANJA	1893000113037	671,00
POLIETILENO BLANCO MATE / TELA NEGRA	1893000113005	671,00
POLIETILENO BLANCO MATE / SEDA PINTADA NEGRA	1893000113038	671,00
POLIETILENO BLANCO MATE / MADERA CHAPADA EN BLANCO	1893000113045	715,00
POLIETILENO BLANCO MATE / MADERA CHAPADA EN GRIS	1893000113046	715,00
OPCIONAL - punto de luz desplazado	6993600413000	99,00

MAX 1x42W FSMH GX24q-4 

ROOM FLUO S5 DIMM

HETTLER/TÜLLMANN, 2009

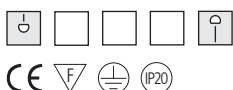
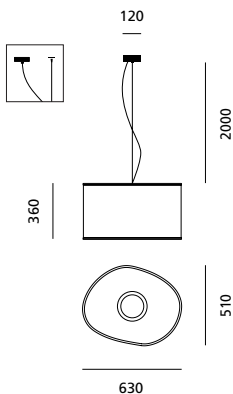

difusor

blanco mate

POLIETILENO BLANCO MATE / TELA CRUDO	1893000213034	770,00
POLIETILENO BLANCO MATE / SEDA PINTADA CRUDO	1893000213035	770,00
POLIETILENO BLANCO MATE / TELA NARANJA	1893000213036	770,00
POLIETILENO BLANCO MATE / SEDA PINTADA NARANJA	1893000213037	770,00
POLIETILENO BLANCO MATE / TELA NEGRA	1893000213005	770,00
POLIETILENO BLANCO MATE / SEDA PINTADA NEGRA	1893000213038	770,00
POLIETILENO BLANCO MATE / MADERA CHAPADA EN BLANCO	1893000213045	814,00
POLIETILENO BLANCO MATE / MADERA CHAPADA EN GRIS	1893000213046	814,00
OPCIONAL - punto de luz desplazado	6993601013000	99,00

MAX 1x42W FSMH GX24q-4 

!! VERIFICAR QUE EL SISTEMA ELECTRICO PUEDA SOPORTAR UN DIMMER DIGITAL !!

SERA SMALL S1

MENGOTTI/PRANDINA, 2002

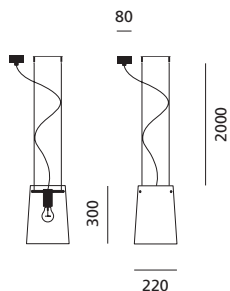

difusor	cromado	niquel cepillado	
CRISTAL BLANCO OPAL	1343000110101	1343000110201	342,00
CRISTAL TRANSPARENTE	1343000110120	1343000110220	342,00
CRISTAL NEGRO OPAL	1343000110105	1343000110205	368,00
CRISTAL ROJO OPAL	1343000110106	1343000110206	386,00
ESPEJO	1343000110107	1343000110207	412,00

CRISTAL TRANSPARENTE	MAX 1x100W IAA/C E27		CRISTAL OPAL	MAX 1x100W IAA/F E27	
	MAX 1x100W IAA/F E27			MAX 1x23W FBG E27	
	MAX 1x100W HAGS/UB E27				
	MAX 1x100W IRR E27				

SERA SMALL S11

MENGOTTI/PRANDINA, 2002

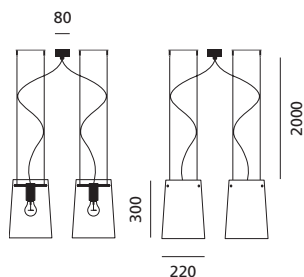

difusor	cromado	niquel cepillado	
CRISTAL BLANCO OPAL	1343000210101	1343000210201	646,00
CRISTAL TRANSPARENTE	1343000210120	1343000210220	646,00
CRISTAL NEGRO OPAL	1343000210105	1343000210205	699,00
CRISTAL ROJO OPAL	1343000210106	1343000210206	735,00
ESPEJO	1343000210107	1343000210207	788,00

CRISTAL TRANSPARENTE	MAX 2x100W IAA/C E27		CRISTAL OPAL	MAX 2x100W IAA/F E27	
	MAX 2x100W IAA/F E27			MAX 2x23W FBG E27	
	MAX 2x100W HAGS/UB E27				
	MAX 2x100W IRR E27				

SERA S1

MENGOTTI/PRANDINA, 2000

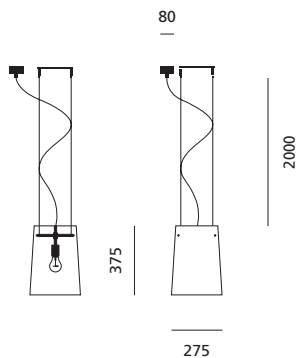

difusor	cromado	niquel cepillado	
CRISTAL BLANCO OPAL	1333000110101	1333000110201	441,00
CRISTAL TRANSPARENTE	1333000110120	1333000110220	441,00
CRISTAL NEGRO OPAL	1333000110105	1333000110205	494,00
CRISTAL ROJO OPAL	1333000110106	1333000110206	520,00
ESPEJO	1333000110107	1333000110207	538,00

CRISTAL TRANSPARENTE	MAX 1x150W IAA/C E27		CRISTAL OPAL	MAX 1x150W IAA/F E27	
	MAX 1x150W IAA/F E27			MAX 1x23W FBG E27	
	MAX 1x100W HAGS/UB E27				
	MAX 1x150W IRR E27				

SERA S11

MENGOTTI/PRANDINA, 2000

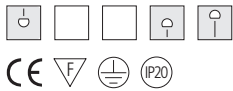
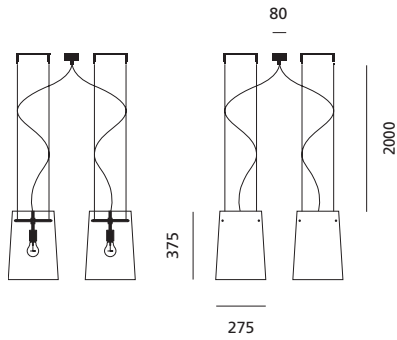

difusor	cromado	níquel cepillado	
CRISTAL BLANCO OPAL	1333000210101	1333000210201	837,00
CRISTAL TRANSPARENTE	1333000210120	1333000210220	837,00
CRISTAL NEGRO OPAL	1333000210105	1333000210205	943,00
CRISTAL ROJO OPAL	1333000210106	1333000210206	978,00
ESPEJO	1333000210107	1333000210207	1031,00

CRISTAL TRANSPARENTE MAX 2x150W IAA/C E27
 MAX 2x150W IAA/F E27
 MAX 2x100W HAGS/UB E27
 MAX 2x150W IRR E27

CRISTAL OPAL MAX 2x150W IAA/F E27
 MAX 2x23W FBG E27

SERA S3

MENGOTTI/PRANDINA, 2000

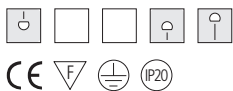
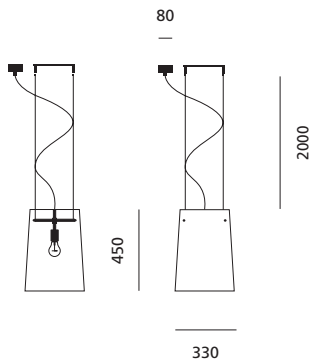

difusor	cromado	níquel cepillado	
CRISTAL BLANCO OPAL	1333000310101	1333000310201	519,00
CRISTAL TRANSPARENTE	1333000310120	1333000310220	527,00
CRISTAL NEGRO OPAL	1333000310105	1333000310205	589,00
CRISTAL ROJO OPAL	1333000310106	1333000310206	625,00
ESPEJO	1333000310107	1333000310207	633,00

CRISTAL TRANSPARENTE MAX 1x150W IAA/C E27
 MAX 1x150W IAA/F E27
 MAX 1x100W HAGS/UB E27
 MAX 1x150W IRR E27

CRISTAL OPAL MAX 1x150W IAA/F E27
 MAX 1x23W FBG E27

TECA S1 (IP40)

UFFICIO TECNICO PRANDINA/AZZOLIN, 2005-2007

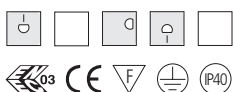
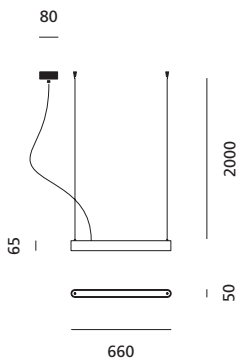

difusor		
ALUMINIO PINTADO BLANCO	1483000113000	455,00
ALUMINIO PINTADO GRIS	1483000113300	455,00

1x24W FDH G5

TECA S1 DIMM (IP40)

UFFICIO TECNICO PRANDINA/AZZOLIN, 2005-2007

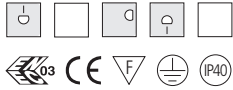
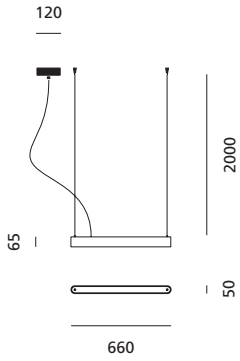

difusor

ALUMINIO PINTADO BLANCO	1483000513000	565,00
ALUMINIO PINTADO GRIS	1483000513300	565,00

1x24W FDH G5 

!! VERIFICAR QUE EL SISTEMA ELECTRICO PUEDA SOPORTAR UN DIMMER DIGITAL !!

TECA S3 (IP40)

UFFICIO TECNICO PRANDINA/AZZOLIN, 2005-2007

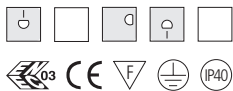
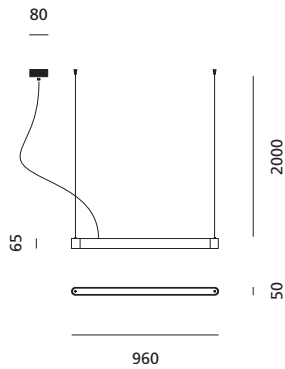

difusor

ALUMINIO PINTADO BLANCO	1483000213000	544,00
ALUMINIO PINTADO GRIS	1483000213300	544,00

1x39W FDH G5 

TECA S3 DIMM (IP40)

UFFICIO TECNICO PRANDINA/AZZOLIN, 2005-2007

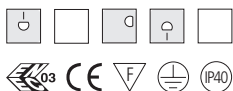
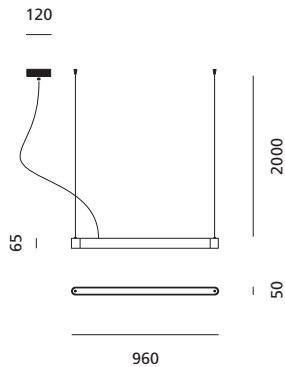

difusor

ALUMINIO PINTADO BLANCO	1483000613000	676,00
ALUMINIO PINTADO GRIS	1483000613300	676,00

1x39W FDH G5 

!! VERIFICAR QUE EL SISTEMA ELECTRICO PUEDA SOPORTAR UN DIMMER DIGITAL !!

TECA S5 (IP40)

UFFICIO TECNICO PRANDINA/AZZOLIN, 2005-2007

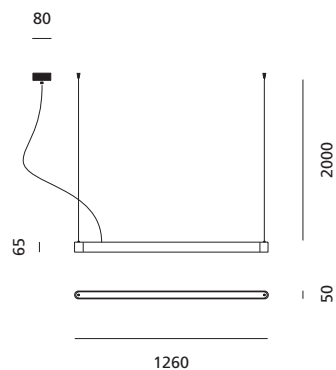

difusor

ALUMINIO PINTADO BLANCO	1483000313000	589,00
ALUMINIO PINTADO GRIS	1483000313300	589,00



1x54W FDH G5 ←



TECA S5 DIMM (IP40)

UFFICIO TECNICO PRANDINA/AZZOLIN, 2005-2007

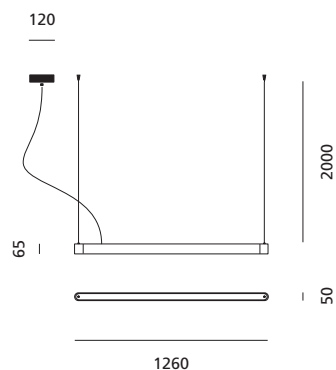

difusor

ALUMINIO PINTADO BLANCO	1483000713000	721,00
ALUMINIO PINTADO GRIS	1483000713300	721,00



1x54W FDH G5 ←

!! VERIFICAR QUE EL SISTEMA ELECTRICO PUEDA SOPORTAR UN DIMMER DIGITAL !!



TECA S7 (IP40)

UFFICIO TECNICO PRANDINA/AZZOLIN, 2005-2007

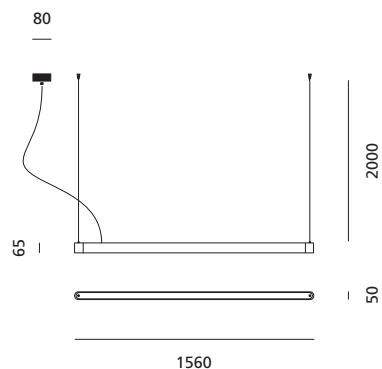

difusor

ALUMINIO PINTADO BLANCO	1483000413000	644,00
ALUMINIO PINTADO GRIS	1483000413300	644,00



1x80W FDH G5 ←



TECA S7 DIMM (IP40)

UFFICIO TECNICO PRANDINA/AZZOLIN, 2005-2007

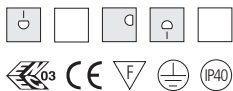
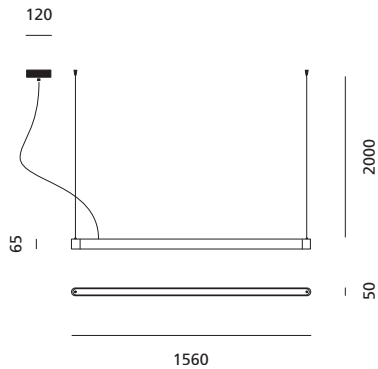

difusor

ALUMINIO PINTADO BLANCO	1483000813000	799,00
ALUMINIO PINTADO GRIS	1483000813300	799,00

1x80W FDH G5 

!! VERIFICAR QUE EL SISTEMA ELECTRICO PUEDA SOPORTAR UN DIMMER DIGITAL !!

WORK S3

MENGOTTI/PRANDINA, 2003

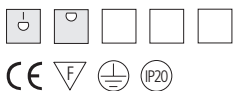
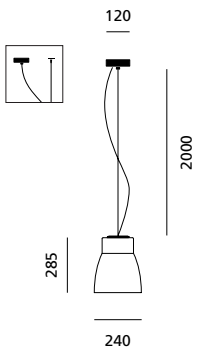



difusor

cromado

niquel cepillado

CRISTAL BLANCO OPAL	1413000110101	1413000110201	319,00
OPCIONAL - punto de luz desplazado	6993600310100	6993600310200	44,00

MAX 1x150W IAA/F E27 
 MAX 1x150W HSGST/F E27 
 1x30W FBT E27 

WORK S33

MENGOTTI/PRANDINA, 2003

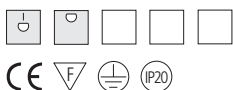
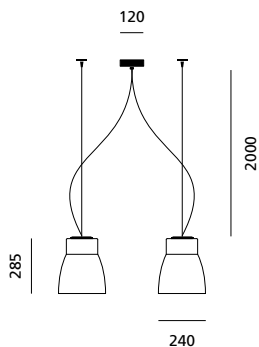



difusor

cromado

niquel cepillado

CRISTAL BLANCO OPAL	1413000510101	1413000510201	568,00
---------------------	---------------	---------------	---------------



MAX 2x150W IAA/F E27 
 MAX 2x150W HSGST/F E27 
 2x30W FBT E27 

WORK S5

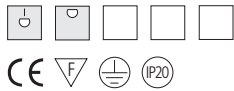
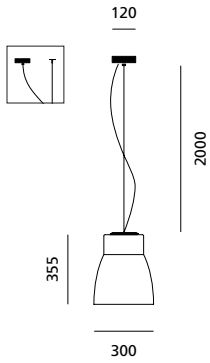
MENGOTTI/PRANDINA, 2003



<i>difusor</i>	<i>cromado</i>	<i>níquel cepillado</i>	
CRISTAL BLANCO OPAL	1413000310101	1413000310201	372,00
OPCIONAL - punto de luz desplazado	6993600310100	6993600310200	44,00

MAX 1x150W IAA/F E27 
 MAX 1x150W HSGST/F E27 
 1x30W FBT E27 

WORK FLUO S5

MENGOTTI/PRANDINA, 2003

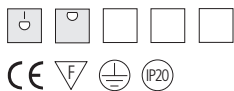
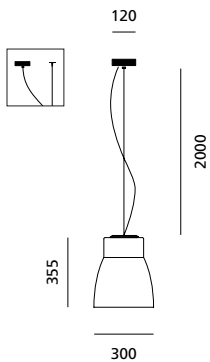

<i>difusor</i>	<i>cromado</i>	<i>níquel cepillado</i>	
CRISTAL BLANCO OPAL	1633000110101	1633000110201	516,00
OPCIONAL - punto de luz desplazado	6993600310100	6993600310200	44,00

1x42W FSMH GX24q-4 

FILTRO PYREX INCLUIDO

ZERO S1G9

MENGOTTI/PRANDINA, 1994-2005

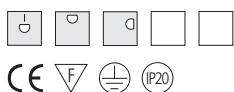
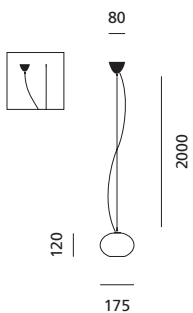

<i>difusor</i>	<i>cromado</i>	<i>níquel cepillado</i>	
CRISTAL BLANCO OPAL	1423001710101	1423001710201	200,00
OPCIONAL - punto de luz desplazado	6993600810100	6993600810200	35,00

MAX 1x75W HSGST/F G9 

ZERO S11G9

MENGOTTI/PRANDINA, 1994-2005

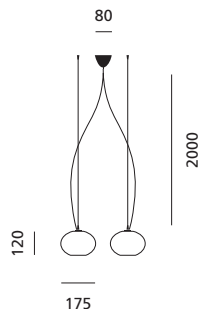

difusor

cromado

níquel cepillado

CRISTAL BLANCO OPAL	1423001810101	1423001810201	363,00
---------------------	---------------	---------------	---------------

MAX 2x75W HSGST/F G9

ZERO S3

MENGOTTI/PRANDINA, 1994

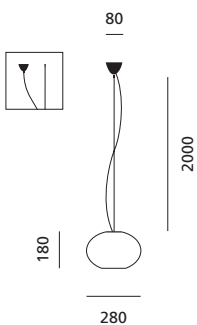

difusor

cromado

níquel cepillado

CRISTAL BLANCO OPAL	1423000310101	1423000310201	302,00
---------------------	---------------	---------------	---------------

OPCIONAL - punto de luz desplazado	6993600810100	6993600810200	35,00
------------------------------------	---------------	---------------	--------------

MAX 1x150W IAA/F E27
MAX 1x150W HSGST/F E27

ZERO S33

MENGOTTI/PRANDINA, 1994

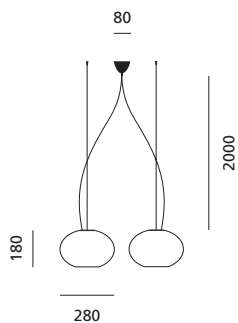

difusor

cromado

níquel cepillado

CRISTAL BLANCO OPAL	1423000710101	1423000710201	584,00
---------------------	---------------	---------------	---------------



MAX 2x150W IAA/F E27
MAX 2x150W HSGST/F E27

ZERO S5

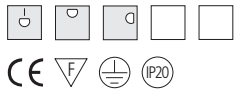
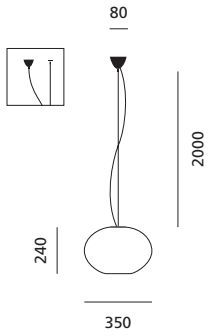
MENGOTTI/PRANDINA, 1994



<i>difusor</i>	<i>cromado</i>	<i>níquel cepillado</i>	
CRISTAL BLANCO OPAL	1423000910101	1423000910201	361,00
OPCIONAL - punto de luz desplazado	6993600910100	6993600910200	46,00



MAX 1x150W IAA/F E27 
 MAX 1x150W HSGST/F E27 
 1x23W FBT E27 

ZERO S7

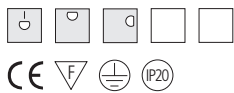
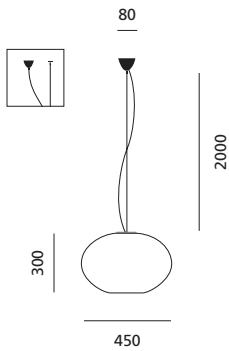
MENGOTTI/PRANDINA, 1994-2006



<i>difusor</i>	<i>cromado</i>	<i>níquel cepillado</i>	
CRISTAL BLANCO OPAL	1423001310101	1423001310201	432,00
OPCIONAL - punto de luz desplazado	6993600910100	6993600910200	46,00

MAX 1x150W IAA/F E27 
 MAX 1x250W HSGST/F E27 
 1x30W FBT E27 

ZERO FLUO S7

MENGOTTI/PRANDINA, 1994-2006

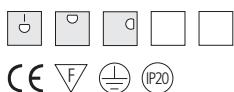
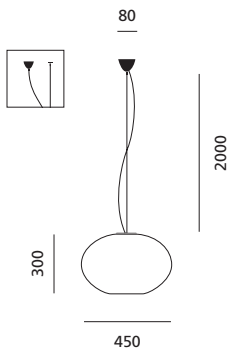

<i>difusor</i>	<i>cromado</i>	<i>níquel cepillado</i>	
CRISTAL BLANCO OPAL	1643000110101	1643000110201	591,00
OPCIONAL - punto de luz desplazado	6993600910100	6993600910200	46,00

1x42W FSMH GX24q-4 

FILTRO PYREX INCLUIDO

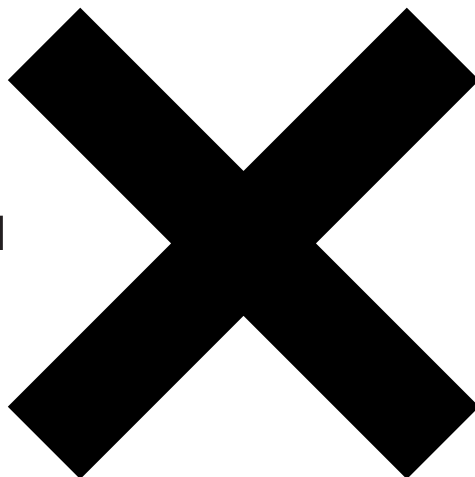

PLAFÓN

BRIKETT FLOOD C1

CHRISTIAN PLODERER, 2008

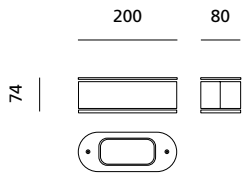

<i>difusor</i>		<i>blanco</i>	<i>negro</i>	
CRISTAL TRANSPARENTE	1801000113020	–		277,00
CRISTAL NEGRO	–		1801000113522	277,00

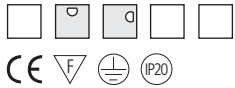

MAX 1x60W HDG R7s 

BRIKETT FLOOD C3

CHRISTIAN PLODERER, 2008

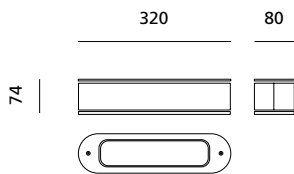

<i>difusor</i>		<i>blanco</i>	<i>negro</i>	
CRISTAL TRANSPARENTE	1801000313020	–		333,00
CRISTAL NEGRO	–		1801000313522	333,00

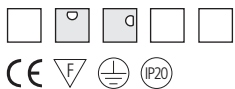

MAX 1x100W HDG R7s 

EQUILIBRE HALO C3

LUC RAMAEL, 2006

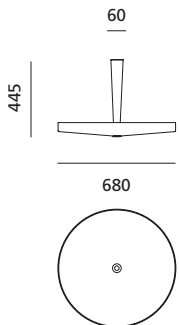

<i>difusor</i>			
ALUMINIO PINTADO BLANCO	1131000113000		1176,00
ALUMINIO PINTADO GRIS	1131000113300		1176,00
OPCIONAL - minispot			20,00

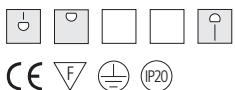

MAX 3x150W HDG R7s  + MAX 1x40W HMGS/UB G9 

EQUILIBRE FLUO C3

LUC RAMAEL, 2006

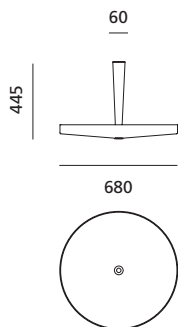

difusor

ALUMINIO PINTADO BLANCO	1511000913000	1287,00
ALUMINIO PINTADO GRIS	1511000913300	1287,00
OPCIONAL - minispot		20,00

4x36W FSD 2G11  + MAX 1x40W HMGS/UB G9 

EQUILIBRE FLUO C3 DIMM

LUC RAMAEL, 2006

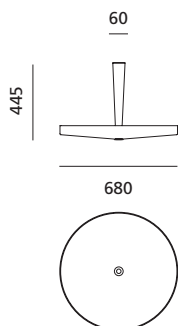

difusor

ALUMINIO PINTADO BLANCO	1511001113000	1563,00
ALUMINIO PINTADO GRIS	1511001113300	1563,00
OPCIONAL - minispot		20,00

4x36W FSD 2G11  + MAX 1x40W HMGS/UB G9 

!! VERIFICAR QUE EL SISTEMA ELECTRICO PUEDA SOPORTAR UN DIMMER DIGITAL !!

EQUILIBRE FLUO C30

LUC RAMAEL, 2010

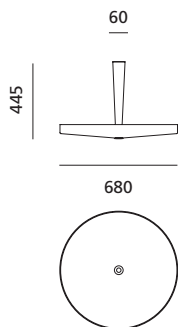

difusor en plexiglas®

BLANCO	1511001313001	1176,00
--------	---------------	----------------

1x22W FSC 2GX13 + 1x40W FSC 2GX13



EXTRA C1

MENGOTTI/PRANDINA, 1994

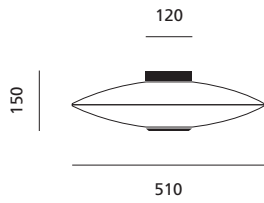



difusor

cromado

níquel cepillado

<i>difusor</i>	<i>cromado</i>	<i>níquel cepillado</i>	
CRISTAL BLANCO / FILTRO BLANCO	1141000110101	1141000110201	406,00
CRISTAL BLANCO + ESPEJO / FILTRO BLANCO	1141000110107	1141000110207	494,00

MAX 1x150W IAA/F E27 
MAX 1x150W HSGST/F E27 

EXTRA C3

MENGOTTI/PRANDINA, 1994

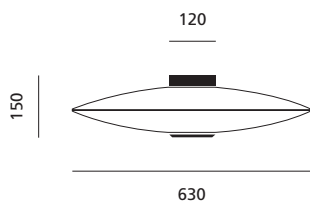



difusor

cromado

níquel cepillado

<i>difusor</i>	<i>cromado</i>	<i>níquel cepillado</i>	
CRISTAL BLANCO / FILTRO BLANCO	1141000210101	1141000210201	497,00
CRISTAL BLANCO + ESPEJO / FILTRO BLANCO	1141000210107	1141000210207	619,00

MAX 1x150W IAA/F E27 
MAX 1x150W HSGST/F E27 

FINLAND C1

MENGOTTI/PRANDINA, 2003-2005

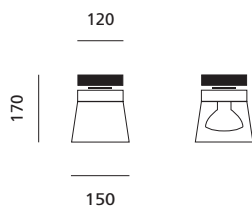





difusor

cromado

níquel cepillado

<i>difusor</i>	<i>cromado</i>	<i>níquel cepillado</i>	
CRISTAL BLANCO OPAL	1151000110101	1151000110201	156,00
CRISTAL TRANSPARENTE	1151000110120	1151000110220	189,00

CRISTAL TRANSPARENTE MAX1x100W HAGS/UB E27 
MAX 1x100W IRR E27 

CRISTAL OPAL MAX 1x100W IAA/F E27 
MAX 1x100W IAM/W E27 

FINLAND C1G

MENGOTTI/PRANDINA, 2003

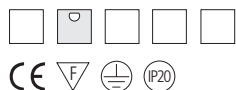

difusor

crystal blanco opal

CRISTAL BLANCO OPAL	1151000210001	178,00
---------------------	---------------	---------------

MAX 1x100W IAA/F E27

MAX 1x100W IAM/W E27

FINLAND C3

MENGOTTI/PRANDINA, 2003-2005

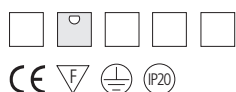
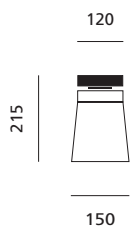

difusor

cromado

níquel cepillado

CRISTAL BLANCO OPAL	1151000410101	1151000410201	179,00
---------------------	---------------	---------------	---------------

MAX 1x100W IAA/F E27

MAX 1x100W IAM/W E27

1x23W FBT E27

FINLAND C3G

MENGOTTI/PRANDINA, 2003

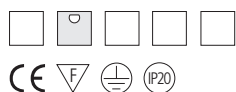
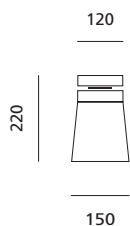

difusor

crystal blanco opal

CRISTAL BLANCO OPAL	1151000510001	195,00
---------------------	---------------	---------------

MAX 1x100W IAA/F E27

MAX 1x100W IAM/W E27

1x23W FBT E27

LIGHT VOLUME FLUO 21C

BAKERYGROUP, 2004

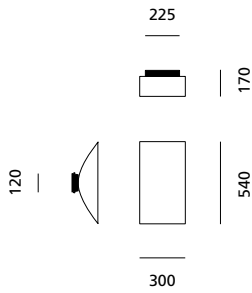

difusor

blanco mate

TELA BLANCA	1461000110001	391,00
OPCIONAL - versión fluorescente dimerable	1461000710001	502,00



1x26W FSQ G24q-3 

LAMPARA DE PARED Y TECHO

!! VERIFICAR QUE EL SISTEMA ELECTRICO PUEDA SOPORTAR UN DIMMER DIGITAL !!



LIGHT VOLUME FLUO 22C

BAKERYGROUP, 2004

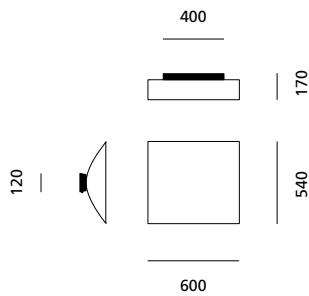

difusor

blanco mate

TELA BLANCA	1461000210001	506,00
OPCIONAL - versión fluorescente dimerable	1461000810001	616,00



1x36W FSD 2G11 

LAMPARA DE PARED Y TECHO

!! VERIFICAR QUE EL SISTEMA ELECTRICO PUEDA SOPORTAR UN DIMMER DIGITAL !!



LIGHT VOLUME FLUO 23C

BAKERYGROUP, 2004

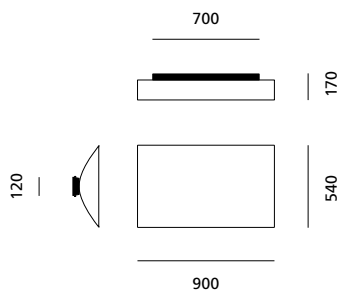

difusor

blanco mate

TELA BLANCA	1461000310001	664,00
OPCIONAL - versión fluorescente dimerable	1461000910001	775,00



1x55W FSDH 2G11 

LAMPARA DE PARED Y TECHO

!! VERIFICAR QUE EL SISTEMA ELECTRICO PUEDA SOPORTAR UN DIMMER DIGITAL !!



MINIMA C1

PAOLO BISTACCHI, 2007

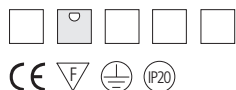
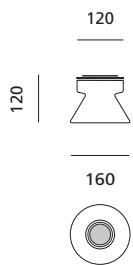

difusor

blanco mate

CRISTAL BLANCO OPAL	1731000110001	200,00
---------------------	---------------	---------------

MAX 1x60W HSGST/F G9

NOTTE C5

MENGOTTI/PRANDINA, 2009

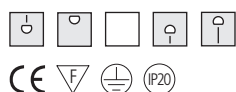
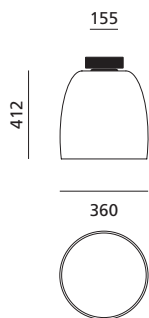

difusor

blanco mate

CRISTAL BLANCO OPAL	1281000110001	496,00
---------------------	---------------	---------------

MAX 1x150W IAA/F E27
 MAX 1x150W HSGST/F E27
 1x30W FBT E27

NOTTE FLUO C5

MENGOTTI/PRANDINA, 2006

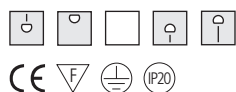
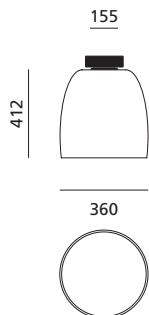

difusor

blanco mate

CRISTAL BLANCO OPAL / FILTRO BLANCO	1621000110001	562,00
-------------------------------------	---------------	---------------

1x42W FSMH GX24q-4

NOTTE FLUO C7

MENGOTTI/PRANDINA, 2006

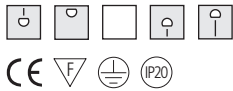
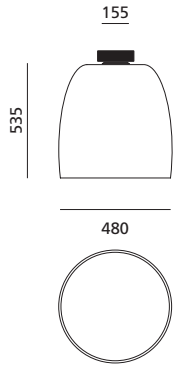

difusor

blanco mate

CRISTAL BLANCO OPAL / FILTRO BLANCO	1621000210001	901,00
-------------------------------------	---------------	---------------

1x42W FSMH GX24q-4 

ROCK C1

UFFICIO TECNICO PRANDINA/AZZOLIN, 2008

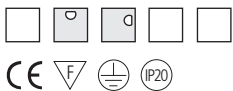

difusor

blanco mate

gris plata mate

CRISTAL BLANCO BRILLANTE	1821000113032	1821000113332	217,00
--------------------------	---------------	---------------	---------------

MAX 1x60W HSGST/F G9 

ROCK C3

UFFICIO TECNICO PRANDINA/AZZOLIN, 2008

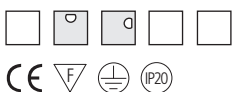



difusor

blanco mate

gris plata mate

CRISTAL BLANCO BRILLANTE	1821000213032	1821000213332	285,00
--------------------------	---------------	---------------	---------------

MAX 1x100W IAA/F E27 
 MAX 1x100W HSGST/F E27 

ROCK FLUO C3

UFFICIO TECNICO PRANDINA/AZZOLIN, 2008

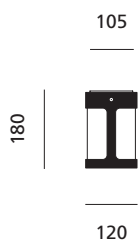

<i>difusor</i>	<i>blanco mate</i>	<i>gris plata mate</i>	
CRISTAL BLANCO BRILLANTE	1831000113032	1831000113332	301,00



1x18W FSMH GX24q-2 

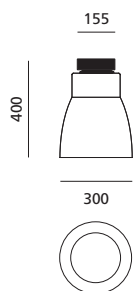

WORK C5

MENGOTTI/PRANDINA, 2009



<i>difusor</i>	<i>blanco mate</i>	
CRISTAL BLANCO OPAL	1411000110001	474,00



MAX 1x150W IAA/F E27 
 MAX 1x150W HSGST/F E27 
 1x30W FBT E27 

WORK FLUO C5

MENGOTTI/PRANDINA, 2006

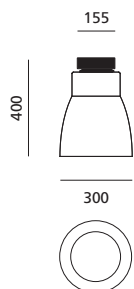

<i>difusor</i>	<i>blanco mate</i>	
CRISTAL BLANCO OPAL / FILTRO BLANCO	1631000110001	546,00



1x42W FSMH GX24q-4 

ZERO C1R

MENGOTTI/PRANDINA, 2003

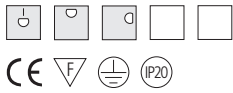
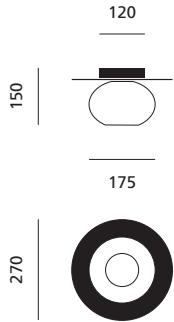

<i>difusor</i>	<i>acero inox. brillante</i>	<i>acero inox. cepillado</i>	
CRISTAL BLANCO OPAL	1421000112201	1421000112301	256,00

MAX 1x100W IAA/F E27
MAX 1x100W IAM/W E27



ZERO C1S

MENGOTTI/PRANDINA, 2003

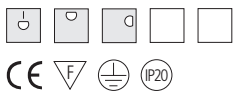
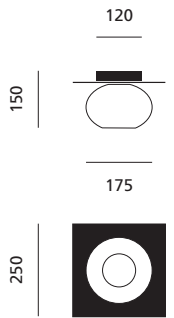

<i>difusor</i>	<i>acero inox. brillante</i>	<i>acero inox. cepillado</i>	
CRISTAL BLANCO OPAL	1421000212201	1421000212301	267,00

MAX 1x100W IAA/F E27
MAX 1x100W IAM/W E27



ZERO C5

MENGOTTI/PRANDINA, 2009

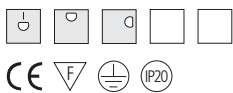
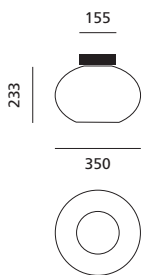

<i>difusor</i>	<i>blanco mate</i>	
CRISTAL BLANCO OPAL	1421000310001	441,00

MAX 1x150W IAA/F E27
MAX 1x150W HSGST/F E27
1x20W FBT E27



ZERO FLUO C5

MENGOTTI/PRANDINA, 2006

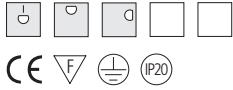
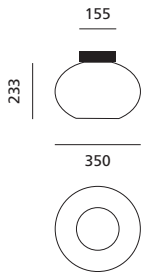

difusor

blanco mate

CRISTAL BLANCO OPAL / FILTRO BLANCO	1641000110001	518,00
-------------------------------------	---------------	---------------

1x32W FSMH GX24q-3 

ZERO FLUO C7

MENGOTTI/PRANDINA, 2006

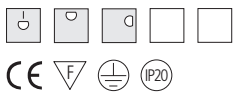
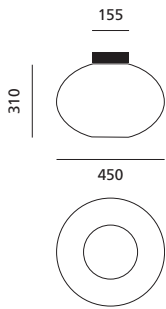

difusor

blanco mate

CRISTAL BLANCO OPAL / FILTRO BLANCO	1641000210001	618,00
-------------------------------------	---------------	---------------

1x42W FSMH GX24q-4 

PARED

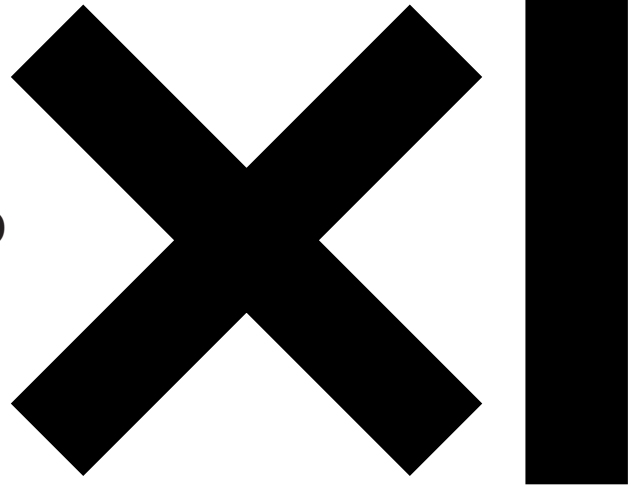

ARGENTUM W3

THEODOR NEUMAIER, 2004

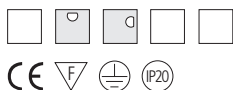
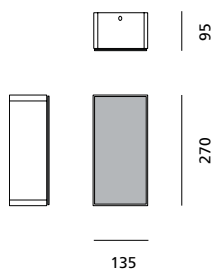

difusor

CRISTAL GLASEADO / CRISTAL BLANCO OPAL	1025000110001	322,00
CRISTAL GLASEADO / ESPEJO	1025000110007	322,00

1x26W FSQ G24q-3

LAMPARA DE PARED Y TECHO

ARGENTUM W4

THEODOR NEUMAIER, 2004

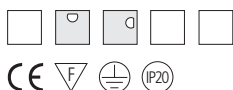
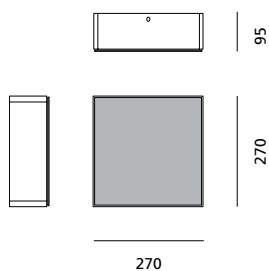

difusor

CRISTAL GLASEADO / CRISTAL BLANCO OPAL	1025000210001	434,00
CRISTAL GLASEADO / ESPEJO	1025000210007	434,00

2x26W FSQ G24q-3

LAMPARA DE PARED Y TECHO

ARGENTUM W7

THEODOR NEUMAIER, 2004

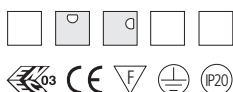
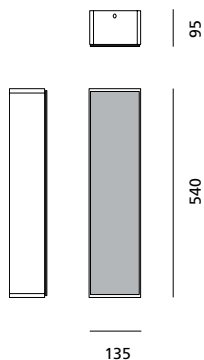

difusor

CRISTAL GLASEADO / CRISTAL BLANCO OPAL	1025000510001	489,00
CRISTAL GLASEADO / ESPEJO	1025000510007	489,00

BAJO PEDIDO - opcional luz emergencia

1x36W FSD 2G11

LAMPARA DE PARED Y TECHO

ARGENTUM W7 DIMM

THEODOR NEUMAIER, 2004

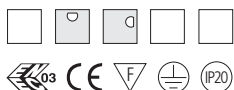
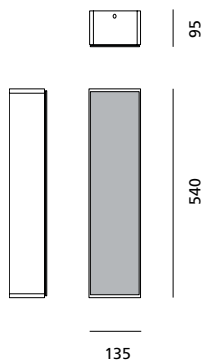

difusor

CRISTAL GLASEADO / CRISTAL BLANCO OPAL	1025000610001	566,00
CRISTAL GLASEADO / ESPEJO	1025000610007	566,00

BAJO PEDIDO - opcional luz emergencia

1x36W FSD 2G11



LAMPARA DE PARED Y TECHO

!! VERIFICAR QUE EL SISTEMA ELECTRICO PUEDA SOPORTAR UN DIMMER DIGITAL !!

ARGENTUM W9

THEODOR NEUMAIER, 2004-2008

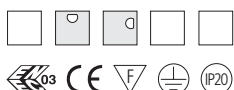
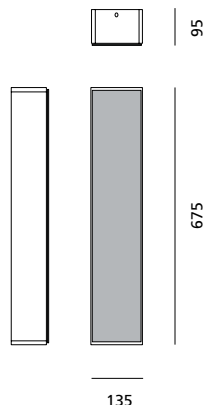

difusor

CRISTAL GLASEADO / CRISTAL BLANCO OPAL	1025000710001	536,00
CRISTAL GLASEADO / ESPEJO	1025000710007	536,00

BAJO PEDIDO - opcional luz emergencia

1x55W FSDH 2G11



LAMPARA DE PARED Y TECHO

ARGENTUM W9 DIMM

THEODOR NEUMAIER, 2004-2008

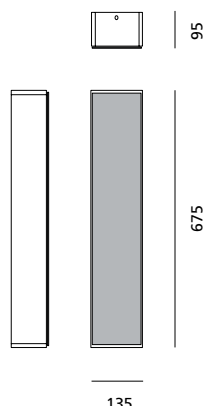

difusor

CRISTAL GLASEADO / CRISTAL BLANCO OPAL	1025000810001	613,00
CRISTAL GLASEADO / ESPEJO	1025000810007	613,00

BAJO PEDIDO - opcional luz emergencia

1x55W FSDH 2G11



LAMPARA DE PARED Y TECHO

!! VERIFICAR QUE EL SISTEMA ELECTRICO PUEDA SOPORTAR UN DIMMER DIGITAL !!

BRIKETT FLOOD W1

CHRISTIAN PLODERER, 2008

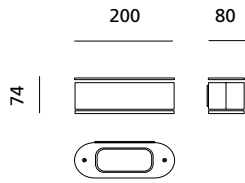

<i>difusor</i>	<i>blanco</i>	<i>negro</i>	
CRISTAL TRANSPARENTE	1805000113020	–	299,00
CRISTAL NEGRO	–	1805000113522	299,00

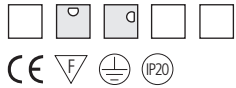

MAX 1x60W HDG R7s 

BRIKETT FLOOD W3

CHRISTIAN PLODERER, 2008

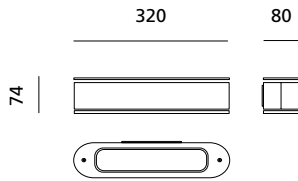

<i>difusor</i>	<i>blanco</i>	<i>negro</i>	
CRISTAL TRANSPARENTE	1805000313020	–	383,00
CRISTAL NEGRO	–	1805000313522	383,00

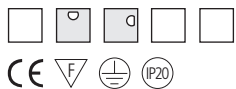

MAX 1x100W HDG R7s 

BRIKETT FLOOD W12

CHRISTIAN PLODERER, 2008

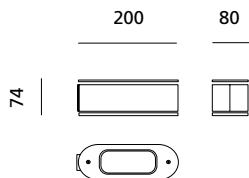

<i>difusor</i>	<i>blanco</i>	<i>negro</i>	
CRISTAL TRANSPARENTE	1805000213020	–	327,00
CRISTAL NEGRO	–	1805000213522	327,00

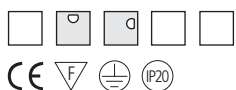

MAX 1x60W HDG R7s 

CPL MINI W1 (IP44)

CHRISTIAN PLODERER, 2008

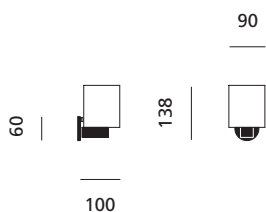

difusor

aluminio cromado

aluminio barnizado
blanco mate

	aluminio cromado	aluminio barnizado blanco mate	
CRISTAL BLANCO OPAL	—	1815000113001	206,00
CRISTAL BLANCO BRILLANTE	1815000110132	—	211,00

MAX 1x60W HSGST/F G9

CPL MINI W3 (IP44)

CHRISTIAN PLODERER, 2008

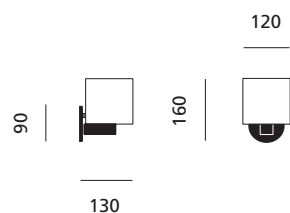

difusor

aluminio cromado

aluminio barnizado
blanco mate

	aluminio cromado	aluminio barnizado blanco mate	
CRISTAL BLANCO OPAL	—	1815000213001	228,00
CRISTAL BLANCO BRILLANTE	1815000210132	—	239,00

MAX 1x60W HSGST/F G9

CPL MINI W5 (IP44)

CHRISTIAN PLODERER, 2008

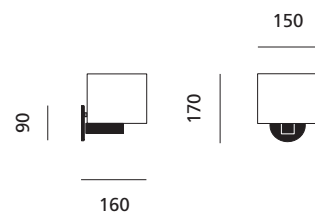

difusor

aluminio cromado

aluminio barnizado
blanco mate

	aluminio cromado	aluminio barnizado blanco mate	
CRISTAL BLANCO OPAL	—	1815000313001	257,00
CRISTAL BLANCO BRILLANTE	1815000310132	—	268,00

MAX 1x75W HSGST/F G9

CPL MINI W1.W3.W5 (IP44)

CHRISTIAN PLODERER, 2008

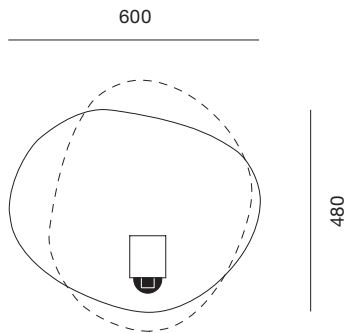

vertical

horizontal

OPCIONAL - espejo	6813000200007	6813000100007	117,00
-------------------	---------------	---------------	---------------

CPL W1

CHRISTIAN PLODERER, 2000

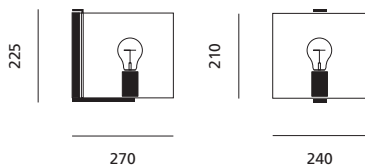

difusor

cromado

níquel cepillado

CRISTAL BLANCO OPAL	1085000110101	1085000110201	380,00
CRISTAL TRANSPARENTE	1085000110120	1085000110220	380,00

CRISTAL TRANSPARENTE MAX 1x150W IAA/C E27 MAX 1x100W IAA/F E27

CRISTAL OPAL MAX 1x100W IAA/F E27 1x23W FBT E27

DUO FLUO W1

ALESSANDRO BALDO, 2007

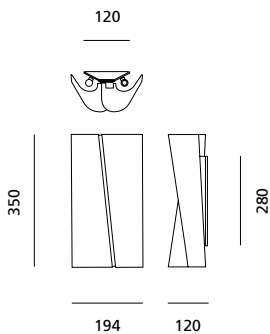

difusor

blanco mate

CRISTAL BLANCO OPAL	1785000210001	441,00
---------------------	---------------	---------------

2x18W FSD 2G11

DUO FLUO W3

ALESSANDRO BALDO, 2007

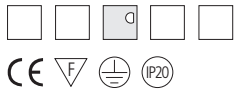
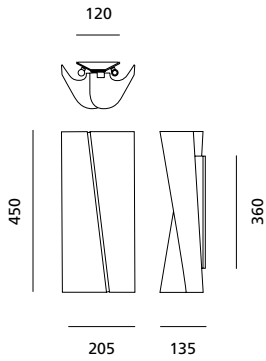

difusor

blanco mate

CRISTAL BLANCO OPAL	1785000110001	494,00
---------------------	---------------	---------------

2x24W FSD 2G11 

FLOU W5

MENGOTTI/PRANDINA, 2003

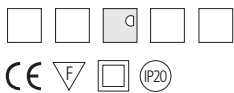
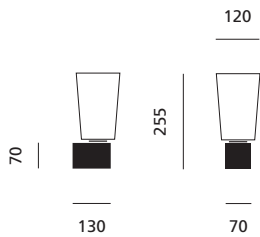



difusor

cromado

níquel cepillado

CRISTAL BLANCO OPAL	1175000310101	1175000310201	173,00
---------------------	---------------	---------------	---------------

MAX 1x100W IAA/F E27 
 MAX 1x100W HSGST/F E27 
 1x23W FBT E27 

LIGHT VOLUME FLUO 21W

BAKERYGROUP, 2004

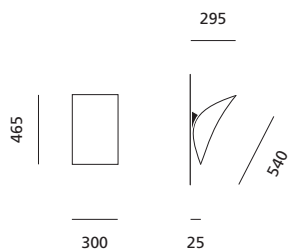

difusor

blanco mate

TELA BLANCA	1465000110001	419,00
OPCIONAL - versión fluorescente dimerable	1465000710001	546,00

1x26W FSQ G24q-3 

!! VERIFICAR QUE EL SISTEMA ELECTRICO PUEDA SOPORTAR UN DIMMER DIGITAL !!

LIGHT VOLUME FLUO 22W

BAKERYGROUP, 2004

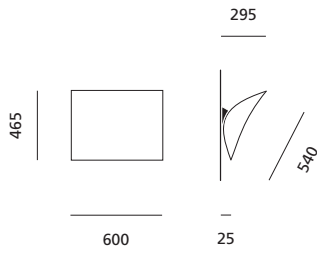

difusor

blanco mate

TELA BLANCA	1465000210001	511,00
OPCIONAL - versión fluorescente dimerable	1465000810001	605,00



1x36W FSD 2G11

!! VERIFICAR QUE EL SISTEMA ELECTRICO PUEDA SOPORTAR UN DIMMER DIGITAL !!

LIGHT VOLUME FLUO 23W

BAKERYGROUP, 2004

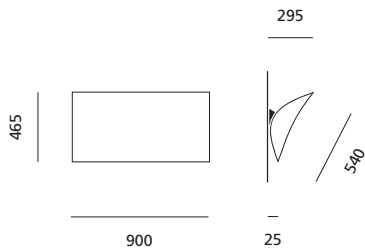

difusor

blanco mate

TELA BLANCA	1465000310001	637,00
OPCIONAL - versión fluorescente dimerable	1465000910001	753,00



1x55W FSDH 2G11

!! VERIFICAR QUE EL SISTEMA ELECTRICO PUEDA SOPORTAR UN DIMMER DIGITAL !!

LIN W1

MENGOTTI/PRANDINA, 1992

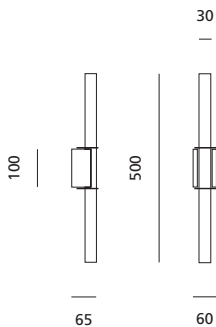

difusor

CRISTAL TRANSPARENTE	1235000110001	140,00
CRISTAL AZUL	1235000110003	140,00
CRISTAL AMBAR	1235000110002	140,00
CRISTAL NEGRO	1235000110022	140,00



MAX 1x60W INT/W S14d

MOOD SMALL W3

MENGOTTI/PRANDINA, 2004

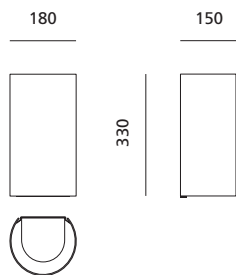

difusor

blanco mate

CRISTAL BLANCO OPAL / FILTRO BLANCO	1265000110041	358,00
-------------------------------------	---------------	---------------



MAX 2x60W IAA/F E27
2x20W FBT E27



MOOD SMALL FLUO W3

MENGOTTI/PRANDINA, 2004

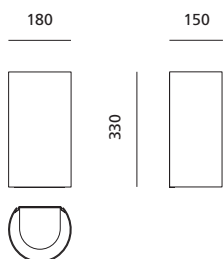

difusor

blanco mate

CRISTAL BLANCO OPAL / FILTRO BLANCO	1265000210041	369,00
-------------------------------------	---------------	---------------



1x26W FSQ G24q-3



MOOD W3

MENGOTTI/PRANDINA, 2002

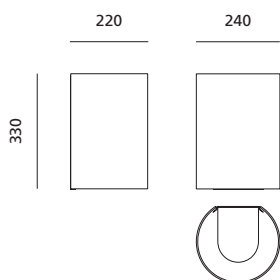

difusor

blanco mate

CRISTAL BLANCO OPAL / FILTRO BLANCO	1255000210041	392,00
-------------------------------------	---------------	---------------



MAX 2x100W IAA/F E27
2x23W FBT E27



MOOD FLUO W3

MENGOTTI/PRANDINA, 2004

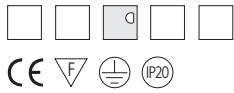
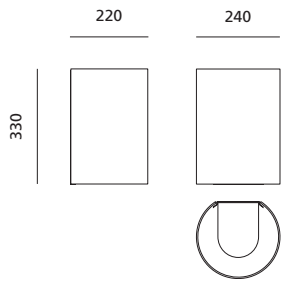

difusor

blanco mate

CRISTAL BLANCO OPAL / FILTRO BLANCO	1255000310041	470,00
-------------------------------------	---------------	---------------

2x26W FSQ G24q-3 

PLATONE W1

FILIPPO PROTASONI, 2009

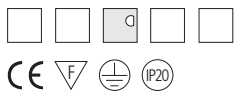
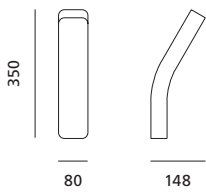

casco en poliuretano barnizado

blanco mate

BLANCO MATE	1945000113000	217,00
-------------	---------------	---------------

MAX 1x60W HSGST/F G9 

PLATONE FLUO W3

FILIPPO PROTASONI, 2009

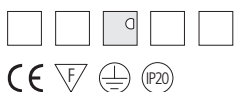
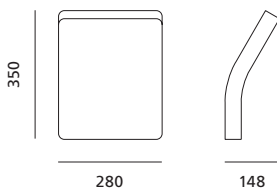

casco en poliuretano barnizado

blanco mate

BLANCO MATE	1955000113000	335,00
-------------	---------------	---------------

BAJO PEDIDO - opcional luz emergencia

1x36W FSS 2G10 

POP W1

LUC RAMAEL, 2006

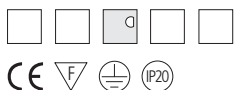
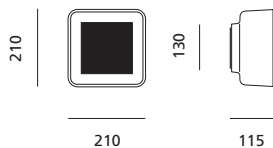

difusor

blanco mate

CRISTAL BLANCO OPAL / BLANCO MATE	1655000113001	312,00
CRISTAL BLANCO OPAL / ESPEJO	1655000110701	339,00

MAX 2x60W HSGST/F G9

POP W2

LUC RAMAEL, 2006

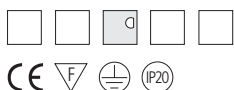
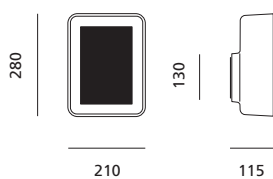

difusor

blanco mate

CRISTAL BLANCO OPAL / BLANCO MATE	1655000213001	329,00
CRISTAL BLANCO OPAL / ESPEJO	1655000210701	379,00

MAX 2x75W HSGST/F G9

POP FLUO W2

LUC RAMAEL, 2006

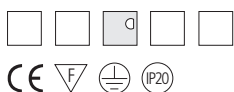
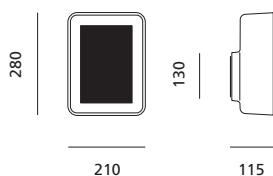

difusor

blanco mate

CRISTAL BLANCO OPAL / BLANCO MATE	1725000213001	356,00
CRISTAL BLANCO OPAL / ESPEJO	1725000210701	401,00

1x32W FSMH GX24q-3

POP FLUO W4

LUC RAMAEL, 2006

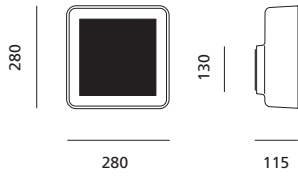

difusor

blanco mate

CRISTAL BLANCO OPAL / BLANCO MATE	1725000413001	408,00
CRISTAL BLANCO OPAL / ESPEJO	1725000410701	447,00



1x42W FSMH GX24q-4

ROCK W1

UFFICIO TECNICO PRANDINA/AZZOLIN, 2008

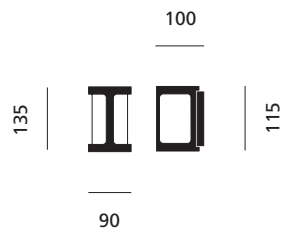

difusor

blanco mate

gris plata mate

CRISTAL BLANCO BRILLANTE	1825000113032	1825000113332	233,00
--------------------------	---------------	---------------	---------------



MAX 1x60W HSGST/F G9

ROCK W3

UFFICIO TECNICO PRANDINA/AZZOLIN, 2008

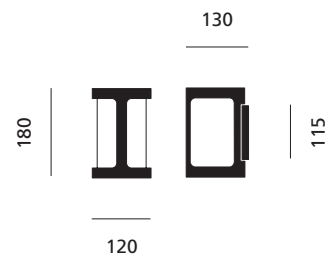

difusor

blanco mate

gris plata mate

CRISTAL BLANCO BRILLANTE	1825000213032	1825000213332	277,00
--------------------------	---------------	---------------	---------------



MAX 1x75W HSGST/F G9

TECA W1 (IP40)

UFFICIO TECNICO PRANDINA/AZZOLIN, 2007

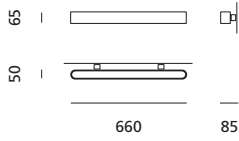

difusor

ALUMINIO PINTADO BLANCO	1485000113000	344,00
ALUMINIO PINTADO GRIS	1485000113300	344,00



1x24W FDH G5 



TECA W1 DIMM (IP40)

UFFICIO TECNICO PRANDINA/AZZOLIN, 2007

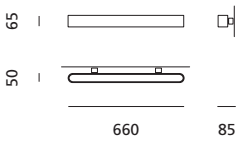

difusor

ALUMINIO PINTADO BLANCO	1485000513000	432,00
ALUMINIO PINTADO GRIS	1485000513300	432,00



1x24W FDH G5 

!! VERIFICAR QUE EL SISTEMA ELECTRICO PUEDA SOPORTAR UN DIMMER DIGITAL !!



TECA W3 (IP40)

UFFICIO TECNICO PRANDINA/AZZOLIN, 2007

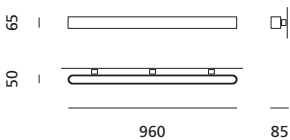

difusor

ALUMINIO PINTADO BLANCO	1485000213000	455,00
ALUMINIO PINTADO GRIS	1485000213300	455,00



1x39W FDH G5 



TECA W3 DIMM (IP40)

UFFICIO TECNICO PRANDINA/AZZOLIN, 2007

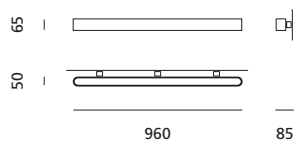

difusor

ALUMINIO PINTADO BLANCO	1485000613000	544,00
ALUMINIO PINTADO GRIS	1485000613300	544,00



1x39W FDH G5 

!! VERIFICAR QUE EL SISTEMA ELECTRICO PUEDA SOPORTAR UN DIMMER DIGITAL !!

TECA W5 (IP40)

UFFICIO TECNICO PRANDINA/AZZOLIN, 2007



difusor

ALUMINIO PINTADO BLANCO	1485000313000	511,00
ALUMINIO PINTADO GRIS	1485000313300	511,00



1x54W FDH G5 

TECA W5 DIMM (IP40)

UFFICIO TECNICO PRANDINA/AZZOLIN, 2007

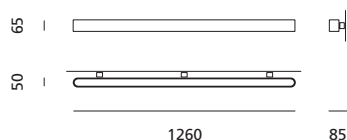

difusor

ALUMINIO PINTADO BLANCO	1485000713000	611,00
ALUMINIO PINTADO GRIS	1485000713300	611,00



1x54W FDH G5 

!! VERIFICAR QUE EL SISTEMA ELECTRICO PUEDA SOPORTAR UN DIMMER DIGITAL !!

TECA W7 (IP40)

UFFICIO TECNICO PRANDINA/AZZOLIN, 2007

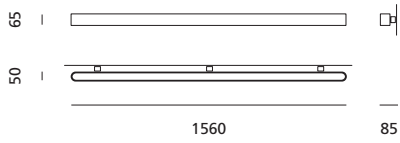

difusor

ALUMINIO PINTADO BLANCO	1485000413000	589,00
ALUMINIO PINTADO GRIS	1485000413300	589,00



1x80W FDH G5



TECA W7 DIMM (IP40)

UFFICIO TECNICO PRANDINA/AZZOLIN, 2007

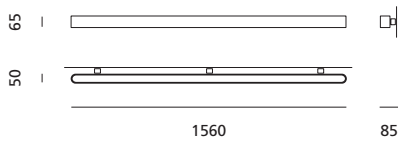

difusor

ALUMINIO PINTADO BLANCO	1485000813000	700,00
ALUMINIO PINTADO GRIS	1485000813300	700,00



1x80W FDH G5



!! VERIFICAR QUE EL SISTEMA ELECTRICO PUEDA SOPORTAR UN DIMMER DIGITAL !!

ZERO W1G9

MENGOTTI/PRANDINA, 1998-2005

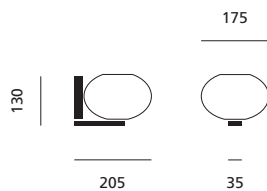

difusor

cromado

níquel cepillado

CRISTAL BLANCO OPAL	1425000610101	1425000610201	277,00
---------------------	---------------	---------------	---------------



MAX 1x60W HSGST/F G9



ZERO W3G9

BOTTIN/MENGOTTI, 1996-2005

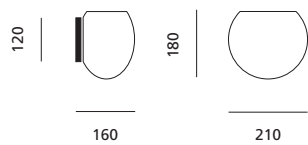

difusor

CRISTAL BLANCO OPAL	1425000710201	240,00
---------------------	---------------	---------------



MAX 1x60W HSGST/F G9 



MESA

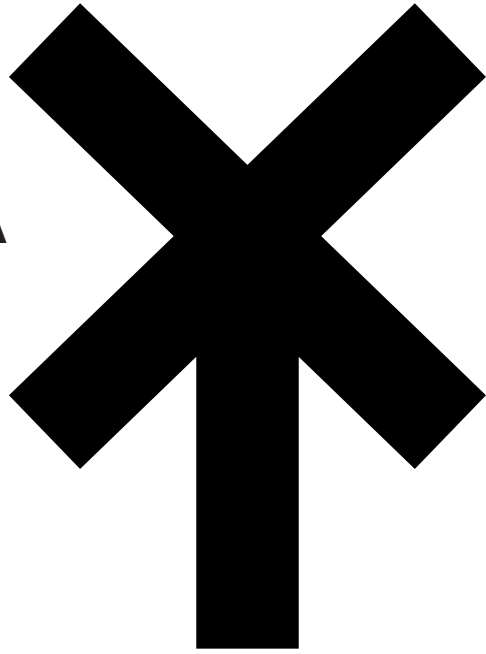

ABC T1

SANDRO SANTANTONIO DESIGN, 2007

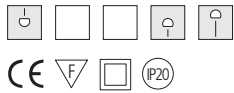
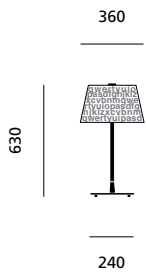

<i>difusor</i>	<i>cromado</i>	<i>blanco mate</i>	
CRISTAL TRANSPARENTE	1754000110120	1754000113020	1064,00
CRISTAL BLANCO OPAL	1754000110101	1754000113001	1097,00
CRISTAL NEGRO	1754000110105	—	1119,00
OPCIONAL - filtro blanco	6902501200001		42,00

MAX 1x100W IAA/F E27
 MAX 1x100W HSGST/F E27

DIMMER INCLUIDO
 mm 1950

ABC T3

SANDRO SANTANTONIO DESIGN, 2007

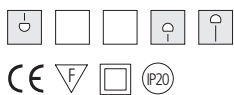
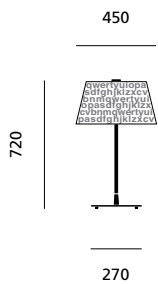

<i>difusor</i>	<i>cromado</i>	<i>blanco mate</i>	
CRISTAL TRANSPARENTE	1754000310120	1754000313020	1405,00
CRISTAL BLANCO OPAL	1754000310101	1754000313001	1483,00
CRISTAL NEGRO	1754000310105	—	1516,00
OPCIONAL - filtro blanco	6902501300001		42,00

MAX 1x150W IAA/F E27
 MAX 1x150W HSGST/F E27

DIMMER INCLUIDO
 mm 2470

CPL SMALL T1

CHRISTIAN PLODERER, 2004

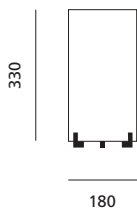

<i>difusor</i>	<i>cromado</i>	<i>níquel cepillado</i>	
CRISTAL BLANCO OPAL	1094000110101	1094000110201	247,00

MAX 1x100W IAG/W E27
 MAX 1x100W IAA/F E27
 1x23W FBG E27

mm 1950

CPL T1

CHRISTIAN PLODERER, 2000

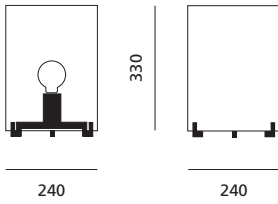

difusor	cromado	níquel cepillado	
CRISTAL BLANCO OPAL	1084000110101	1084000110201	364,00
CRISTAL TRANSPARENTE	1084000110120	1084000110220	385,00

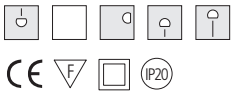

CRISTAL TRANSPARENTE MAX 1x150W IAG/W E27
 MAX 1x150W IAA/C E27
 MAX 1x150W IRR E27

CRISTAL OPAL MAX 1x150W IAG/W E27
 MAX 1x150W IAA/F E27
 1x23W FBG E27

mm 1950

CPL T3

CHRISTIAN PLODERER, 2000

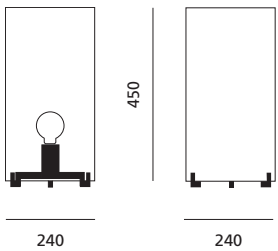

difusor	cromado	níquel cepillado	
CRISTAL BLANCO OPAL	1084000210101	1084000210201	428,00
CRISTAL TRANSPARENTE	1084000210120	1084000210220	449,00

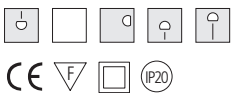

CRISTAL TRANSPARENTE MAX 1x150W IAG/W E27
 MAX 1x150W IAA/C E27
 MAX 1x150W IRR E27

CRISTAL OPAL MAX 1x150W IAG/W E27
 MAX 1x150W IAA/F E27
 1x23W FBG E27

mm 1950

CPL T30

CHRISTIAN PLODERER, 2005

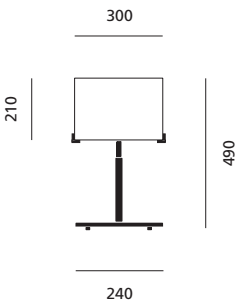

difusor	cromado	níquel cepillado	
CRISTAL BLANCO OPAL	1084000510101	1084000510201	582,00
CRISTAL NEGRO OPAL	1084000510105	1084000510205	672,00
CRISTAL ROJO OPAL	1084000510106	1084000510206	687,00
ESPEJO	1084000510107	1084000510207	698,00

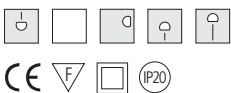

MAX 1x100W IAA/F E27
 MAX 1x150W HSGST/F E27

DIMMER INCLUIDO

mm 2070

CPL T31

CHRISTIAN PLODERER, 2005

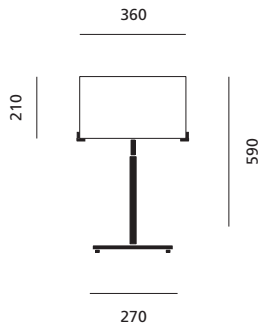

difusor	cromado	níquel cepillado	
CRISTAL BLANCO OPAL	1084000610101	1084000610201	680,00
CRISTAL NEGRO OPAL	1084000610105	1084000610205	785,00
CRISTAL ROJO OPAL	1084000610106	1084000610206	827,00
ESPEJO	1084000610107	1084000610207	848,00

MAX 1x100W IAA/F E27
MAX 1x150W HSGST/F E27

DIMMER INCLUIDO
 mm 1980

CPL T7

CHRISTIAN PLODERER, 2003

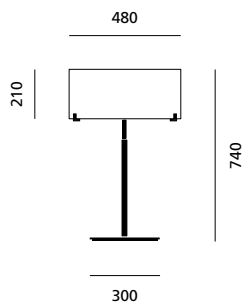

difusor	cromado	níquel cepillado	
CRISTAL BLANCO OPAL	1084000410101	1084000410201	935,00
CRISTAL NEGRO OPAL	1084000410105	1084000410205	1023,00
CRISTAL ROJO OPAL	1084000410106	1084000410206	1056,00
ESPEJO	1084000410107	1084000410207	1112,00

MAX 3x60W IAA/F E27

DIMMER INCLUIDO
 mm 1830

GINGER SMALL T1

UFFICIO TECNICO PRANDINA/AZZOLIN, 2009

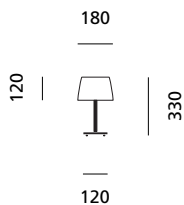

difusor	blanco mate		
CRISTAL BLANCO OPAL	1914000113001		201,00

MAX 1x40W HSGST/F G9

mm 1785

GINGER T3

UFFICIO TECNICO PRANDINA/AZZOLIN, 2009

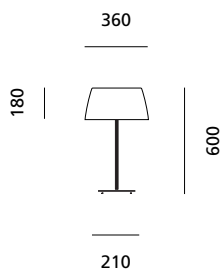

difusor

blanco mate

BLANCO OPAL PLEXIGLAS®	1904000113001	420,00
------------------------	---------------	--------



MAX 2x60W HSGST/F G9

DIMMER TACTIL INCLUIDO
 mm 1870



GINGER T30

UFFICIO TECNICO PRANDINA/AZZOLIN, 2010

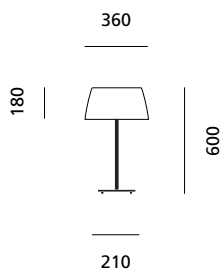

difusor

blanco mate

BLANCO OPAL PLEXIGLAS®	1904000413001	420,00
------------------------	---------------	--------



MAX 2x12W FBG E27

mm 1870



GINGER T5

UFFICIO TECNICO PRANDINA/AZZOLIN, 2009

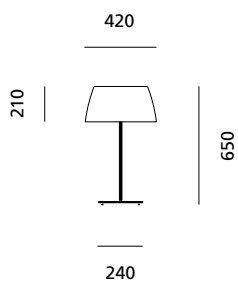

difusor

blanco mate

BLANCO OPAL PLEXIGLAS®	1904000313001	514,00
------------------------	---------------	--------



MAX 2x75W HSGST/F G9

DIMMER TACTIL INCLUIDO
 mm 2500



GINGER T50

UFFICIO TECNICO PRANDINA/AZZOLIN, 2010

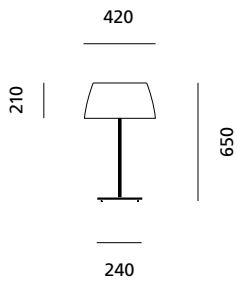

difusor

blanco mate

BLANCO OPAL PLEXIGLAS®	1904000513001	514,00
------------------------	---------------	--------



MAX 2x12W FBG E27 

 mm 2500



GINGER T7

UFFICIO TECNICO PRANDINA/AZZOLIN, 2009

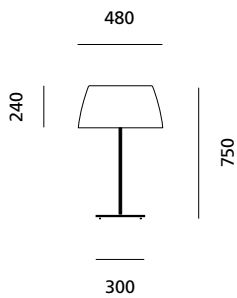

difusor

blanco mate

BLANCO OPAL PLEXIGLAS®	1904000213001	633,00
------------------------	---------------	--------

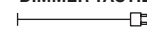

MAX 2x75W HSGST/F G9 

DIMMER TACTIL INCLUIDO
 mm 2335



GINGER T70

UFFICIO TECNICO PRANDINA/AZZOLIN, 2010

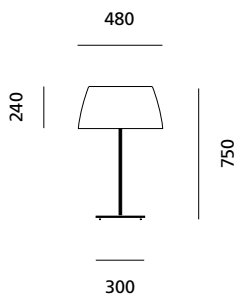

difusor

blanco mate

BLANCO OPAL PLEXIGLAS®	1904000613001	633,00
------------------------	---------------	--------



MAX 2x12W FBG E27 

 mm 2335



GLAM SMALL T1

LUC RAMAEL, 2009

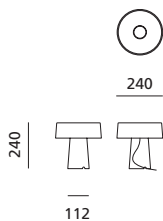

base / difusor

blanco mate

CRISTAL TRANSPARENTE / CRISTAL BLANCO OPAL	1884000110001	261,00
--	---------------	---------------



MAX 1x40W HSGST/F G9

mm 1840



GLAM SMALL T3

LUC RAMAEL, 2009

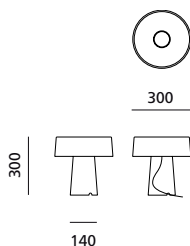

base / difusor

blanco mate

CRISTAL TRANSPARENTE / CRISTAL BLANCO OPAL	1884000210001	334,00
--	---------------	---------------



MAX 1x60W HSGST/F G9

mm 1785



GLAM T1

LUC RAMAEL, 2005

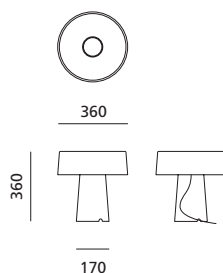

base / difusor

CRISTAL BLANCO OPAL / CRISTAL BLANCO OPAL	1474000113001	536,00
CRISTAL TRANSPARENTE / CRISTAL BLANCO OPAL	1474000112001	536,00
CRISTAL TRANSPARENTE / CRISTAL NEGRO OPAL	1474000112005	619,00
CRISTAL TRANSPARENTE / CRISTAL ROJO OPAL	1474000112006	661,00
CRISTAL TRANSPARENTE / ESPEJO	1474000112007	661,00



MAX 3x40W HSGST/F G9

DIMMER INCLUIDO

mm 2200



GLAM T3

LUC RAMAEL, 2005

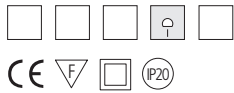
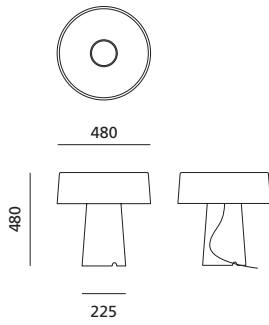

base / difusor

CRISTAL BLANCO OPAL / CRISTAL BLANCO OPAL	1474000213001	743,00
CRISTAL TRANSPARENTE / CRISTAL BLANCO OPAL	1474000212001	785,00
CRISTAL TRANSPARENTE / CRISTAL NEGRO OPAL	1474000212005	921,00
CRISTAL TRANSPARENTE / CRISTAL ROJO OPAL	1474000212006	963,00
CRISTAL TRANSPARENTE / ESPEJO	1474000212007	1005,00

MAX 3x60W HSGST/F G9

DIMMER INCLUIDO

mm 2100

LIGHT VOLUME 21T

BAKERYGROUP, 2000

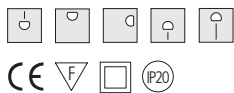
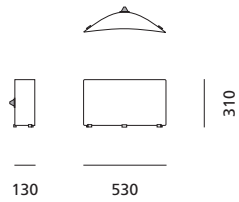

difusor

TELA BLANCA	1224000110001	241,00
-------------	---------------	---------------

MAX 1x40W IBP/F E14

mm 2000

LIGHT VOLUME 22T

BAKERYGROUP, 2000

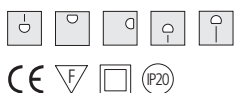
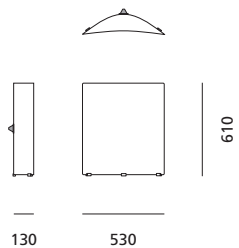

difusor

TELA BLANCA	1224000210001	292,00
-------------	---------------	---------------

MAX 1x60W IBP/F E14

mm 2000

NOTTE T3

PRANDINA, 2008

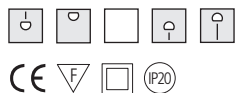
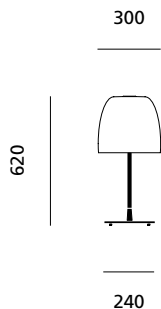

difusor

cromado

blanco mate

CRISTAL BLANCO BRILLANTE	1284000110132	1284000113032	585,00
--------------------------	---------------	---------------	---------------

MAX 1x150W IAA/F E27
MAX 1x150W HSGST/F E27

DIMMER INCLUIDO

mm 1950

NOTTE T5

PRANDINA, 2008

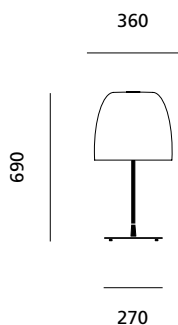

difusor

cromado

blanco mate

CRISTAL BLANCO BRILLANTE	1284000210132	1284000213032	708,00
--------------------------	---------------	---------------	---------------

MAX 1x150W IAA/F E27
MAX 1x150W HSGST/F E27

DIMMER INCLUIDO

mm 2470

SERA SMALL T1

MENGOTTI/PRANDINA, 2005

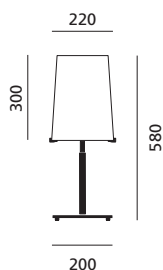

difusor

cromado

níquel cepillado

CRISTAL BLANCO OPAL	1344000110101	1344000110201	386,00
CRISTAL NEGRO OPAL	1344000110105	1344000110205	445,00
CRISTAL ROJO OPAL	1344000110106	1344000110206	465,00
ESPEJO	1344000110107	1344000110207	475,00

MAX 1x150W IAA/F E27
MAX 1x150W HSGST/F E27

DIMMER INCLUIDO

mm 2040

SERA T1

MENGOTTI/PRANDINA, 2005

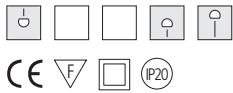
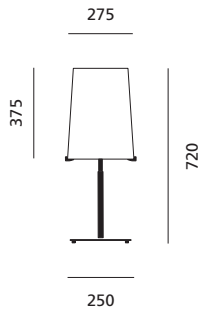

<i>difusor</i>	<i>cromado</i>	<i>níquel cepillado</i>	
CRISTAL BLANCO OPAL	1334000310101	1334000310201	480,00
CRISTAL NEGRO OPAL	1334000310105	1334000310205	549,00
CRISTAL ROJO OPAL	1334000310106	1334000310206	579,00
ESPEJO	1334000310107	1334000310207	609,00

MAX 1x150W IAA/F E27
MAX 1x150W HSGST/F E27

DIMMER INCLUIDO
 mm 1960

TAU T3

PASETTI/OLIVIERI, 2009

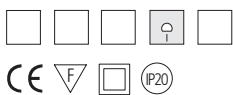
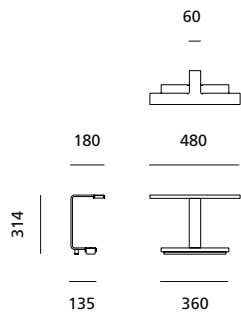

<i>difusor</i>		
METAL BARNIZADO EN BLANCO CON ACABADO SOFT TOUCH	1934000113000	427,00

LED 4x3,6W

mm 2430

TECA T1

UFFICIO TECNICO PRANDINA/AZZOLIN, 2005-2007

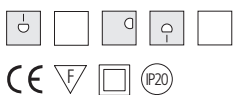
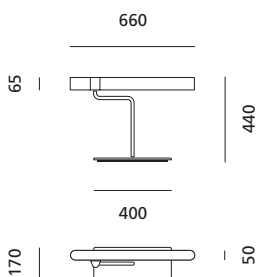

<i>difusor</i>		
ALUMINIO PINTADO BLANCO	1484000113000	715,00
ALUMINIO PINTADO GRIS	1484000113300	715,00

1x24W FDH G5

mm 2430

TECA T12

UFFICIO TECNICO PRANDINA/AZZOLIN, 2005-2007

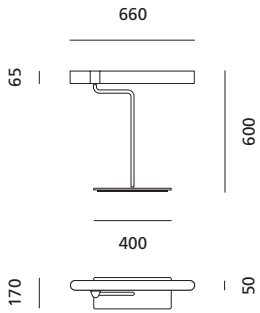

difusor

ALUMINIO PINTADO BLANCO	1484000213000	739,00
ALUMINIO PINTADO GRIS	1484000213300	739,00



1x24W FDH G5 

 mm 2270



PIÉ

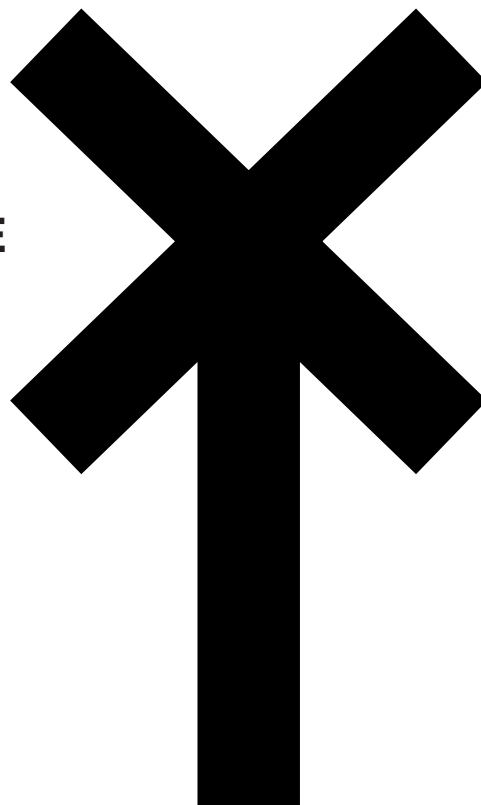

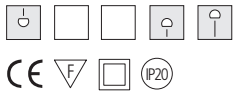
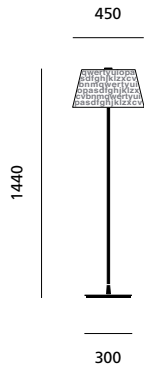

ABC F3

SANDRO SANTANTONIO DESIGN, 2007



<i>difusor</i>	<i>cromado</i>	<i>blanco mate</i>	
CRISTAL TRANSPARENTE	1752000210120	1752000213020	1489,00
CRISTAL BLANCO OPAL	1752000210101	1752000213001	1566,00
CRISTAL NEGRO	1752000210105	—	1644,00
OPCIONAL - filtro blanco		6902501300001	42,00

MAX 1x150W IAA/F E27 
MAX 1x250W HSGST/F E27 



DIMMER INCLUIDO
 mm 2853

ABC F5

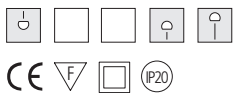
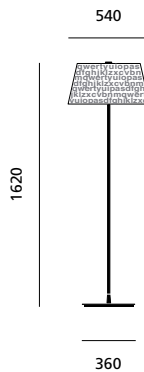
SANDRO SANTANTONIO DESIGN, 2007



<i>difusor</i>	<i>cromado</i>	<i>blanco mate</i>	
CRISTAL TRANSPARENTE	1752000310120	1752000313020	2134,00
CRISTAL BLANCO OPAL	1752000310101	1752000313001	2244,00
CRISTAL NEGRO	1752000310105	—	2343,00
OPCIONAL - filtro blanco		6902501300001	42,00

MAX 1x150W IAA/F E27 
MAX 1x250W HSGST/F E27 

DIMMER INCLUIDO
 mm 2693

BILUNA F7

LUC RAMAEL, 2008

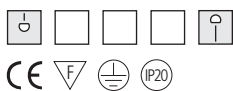
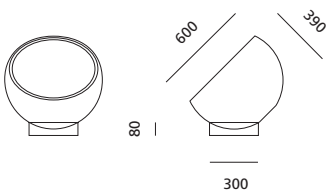

PP *polipropileno difusor*

NEGRO MATE	1872000113500	1122,00
------------	---------------	----------------

difusor en polipropileno barnizado

BLANCO BRILLANTE	1762000114500	1442,00
NEGRO BRILLANTE	1762000114600	1442,00
NEGRO MATE	1762000113500	1442,00
BEIGE MATE	1762000114400	1442,00

1x55W FSC 2GX13 

 mm 2800

BILUNA F7 DIMM (dimmer incorporado en el cable)

LUC RAMAEL, 2008

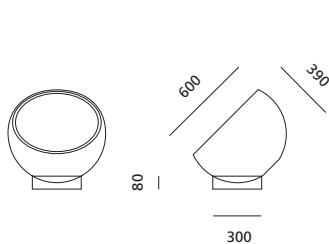

polipropileno difusor

NEGRO MATE	1872000213500	1188,00
------------	---------------	---------

difusor en polipropileno barnizado

BLANCO BRILLANTE	1762000214500	1553,00
NEGRO BRILLANTE	1762000214600	1553,00
NEGRO MATE	1762000213500	1553,00
BEIGE MATE	1762000214400	1553,00



1x55W FSC 2GX13



mm 2800

BILUNA F9

LUC RAMAEL, 2008

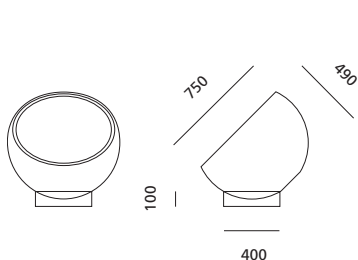

polipropileno difusor

NEGRO MATE	1872000313500	1387,00
------------	---------------	---------

difusor en polipropileno barnizado

BLANCO BRILLANTE	1762000314500	1674,00
NEGRO BRILLANTE	1762000314600	1674,00
NEGRO MATE	1762000313500	1674,00
BEIGE MATE	1762000314400	1674,00



1x55W FSC 2GX13



mm 2800

BILUNA F9 DIMM (dimmer incorporado en el cable)

LUC RAMAEL, 2008

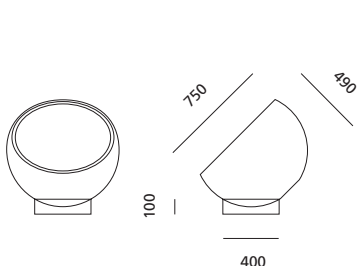

polipropileno difusor

NEGRO MATE	1872000413500	1420,00
------------	---------------	---------

difusor en polipropileno barnizado

BLANCO BRILLANTE	1762000414500	1884,00
NEGRO BRILLANTE	1762000414600	1884,00
NEGRO MATE	1762000413500	1884,00
BEIGE MATE	1762000414400	1884,00



1x55W FSC 2GX13



mm 2800

CPL F1

CHRISTIAN PLODERER, 2000

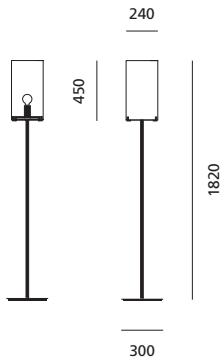

difusor	cromado	níquel cepillado	
CRISTAL BLANCO OPAL	1082000110101	1082000110201	891,00
CRISTAL TRANSPARENTE	1082000110120	1082000110220	946,00

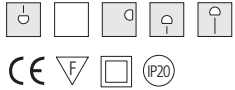

CRISTAL TRANSPARENTE MAX 1x150W IAG/W E27
MAX 1x150W IAA/C E27

CRISTAL OPAL MAX 1x150W IAG/W E27
MAX 1x150W IAA/F E27
MAX 1x250W HSGST/F E27

DIMMER INCLUIDO
mm 2690

CPL F3

CHRISTIAN PLODERER, 2000

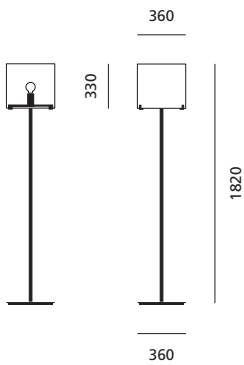

difusor	cromado	níquel cepillado	
CRISTAL BLANCO OPAL	1082000210101	1082000210201	1003,00
CRISTAL TRANSPARENTE	1082000210120	1082000210220	1003,00

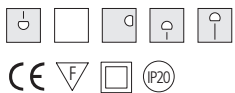

CRISTAL TRANSPARENTE MAX 1x150W IAG/W E27
MAX 1x150W IAA/C E27

CRISTAL OPAL MAX 1x150W IAG/W E27
MAX 1x150W IAA/F E27
MAX 1x250W HSGST/F E27

DIMMER INCLUIDO
mm 2570

CPL F31

CHRISTIAN PLODERER, 2005

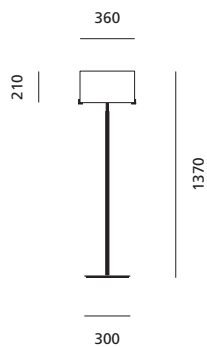

difusor	cromado	níquel cepillado	
CRISTAL BLANCO OPAL	1082000510101	1082000510201	888,00
CRISTAL NEGRO OPAL	1082000510105	1082000510205	998,00
CRISTAL ROJO OPAL	1082000510106	1082000510206	1031,00
ESPEJO	1082000510107	1082000510207	1053,00



MAX 1x100W IAA/F E27
MAX 1x150W HSGST/F E27

DIMMER INCLUIDO
mm 3020

CPL F7

CHRISTIAN PLODERER, 2003

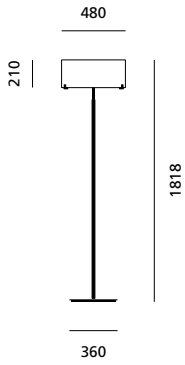

difusor	cromado	níquel cepillado	
CRISTAL BLANCO OPAL	1082000410101	1082000410201	1061,00
CRISTAL NEGRO OPAL	1082000410105	1082000410205	1193,00
CRISTAL ROJO OPAL	1082000410106	1082000410206	1226,00
ESPEJO	1082000410107	1082000410207	1282,00

MAX 3x60W IAA/F E27

DIMMER INCLUIDO

mm 2410

EQUILIBRE HALO F3

LUC RAMAEL, 2004

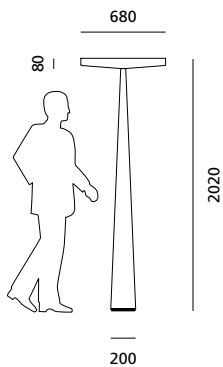

polipropileno pintado mate y aluminio	RAL		
BLANCO	9010	1132000113000	1903,00
AMARILLO	1016	1132000113800	1903,00
NEGRO	9011	1132000113500	1903,00

MAX 1x500W HDG R7s

DIMMER INCLUIDO

mm 2380

EQUILIBRE FLUO F3

LUC RAMAEL, 2004

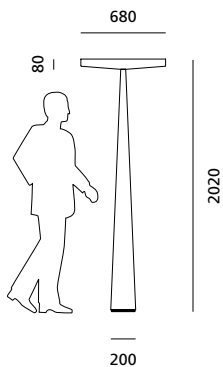

polipropileno pintado mate y aluminio	RAL		
BLANCO	9010	1512000113000	2179,00
AMARILLO	1016	1512000113800	2179,00
NEGRO	9011	1512000113500	2179,00

4x36W FSD 2G11

DIMMER INCLUIDO

mm 2380

EQUILIBRE FLUO F30

LUC RAMAEL, 2008

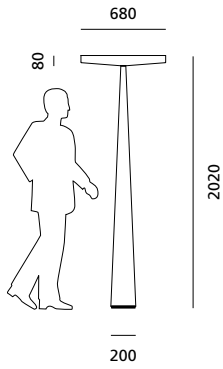

polietileno plexiglas®

BLANCO	1512000213001	1792,00
--------	---------------	---------



1x22W FSC 2GX13 + 1x40W FSC 2GX13



mm 2380



EQUILIBRE FLUO F33 OUTDOOR

LUC RAMAEL, 2010

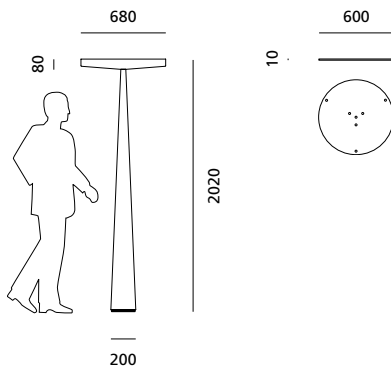

difusor y columna en polietileno

BLANCO	1512000313001	1422,00
BAJO PEDIDO - base para fijar al suelo en acero inox. cepillado	6101908100000	320,00



1x22W FSC 2GX13 + 1x40W FSC 2GX13



GINGER F3

UFFICIO TECNICO PRANDINA/AZZOLIN, 2009

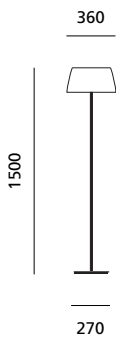

difusor

blanco mate

BLANCO OPAL PLEXIGLAS®	1902000113001	489,00
------------------------	---------------	--------



MAX 2x60W HSGST/F G9

DIMMER INCLUIDO
mm 2610



GINGER F30

UFFICIO TECNICO PRANDINA/AZZOLIN, 2010

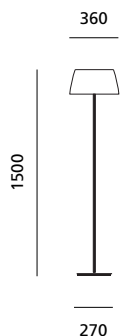

difusor	blanco mate	
BLANCO OPAL PLEXIGLAS®	1902000413001	489,00



MAX 2x12W FBG E27

mm 2610



GINGER F5

UFFICIO TECNICO PRANDINA/AZZOLIN, 2009

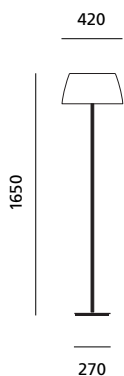

difusor	blanco mate	
BLANCO OPAL PLEXIGLAS®	1902000313001	559,00



MAX 2x75W HSGST/F G9

DIMMER INCLUIDO
 mm 2480



GINGER F50

UFFICIO TECNICO PRANDINA/AZZOLIN, 2010



difusor	blanco mate	
BLANCO OPAL PLEXIGLAS®	1902000513001	559,00



MAX 2x12W FBG E27

mm 2480



GINGER F7

UFFICIO TECNICO PRANDINA/AZZOLIN, 2009

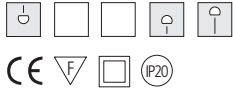
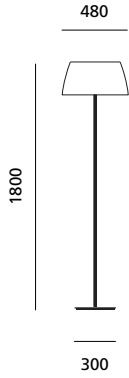

difusor

blanco mate

BLANCO OPAL PLEXIGLAS®	1902000213001	658,00
------------------------	---------------	--------

MAX 2x75W HSGST/F G9

DIMMER INCLUIDO

mm 2330

GINGER F70

UFFICIO TECNICO PRANDINA/AZZOLIN, 2010

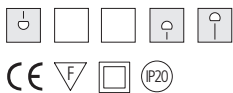
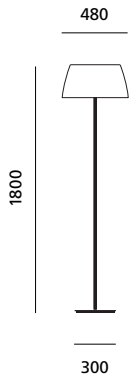

difusor

blanco mate

BLANCO OPAL PLEXIGLAS®	1902000613001	658,00
------------------------	---------------	--------

MAX 2x12W FBG E27

mm 2330

LIGHT VOLUME 33F

BAKERYGROUP, 2000

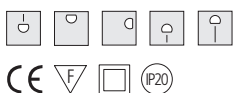
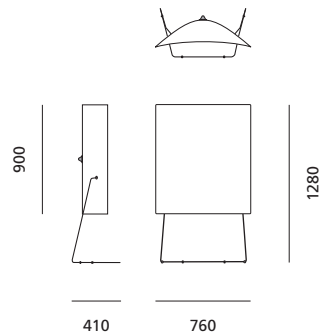

difusor

TELA BLANCA	1222000210001	790,00
-------------	---------------	--------

MAX 1x100W IAA/F E27
1x24W FBC E27

mm 3300

NOTTE F3

PRANDINA, 2008

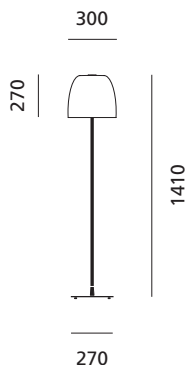

difusor	cromado	blanco mate	
CRISTAL BLANCO BRILLANTE	1282000110132	1282000113032	729,00

MAX 1x150W IAA/F E27
MAX 1x150W HSGST/F E27

DIMMER INCLUIDO
 mm 2853

NOTTE F5

PRANDINA, 2008

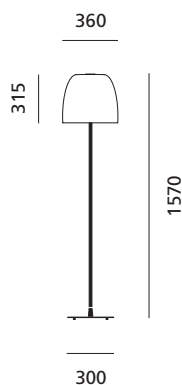

difusor	cromado	blanco mate	
CRISTAL BLANCO BRILLANTE	1282000210132	1282000213032	842,00

MAX 1x150W IAA/F E27
MAX 1x150W HSGST/F E27

DIMMER INCLUIDO
 mm 2693

ROOM FLUO F5

HETTLER/TÜLLMANN, 2009

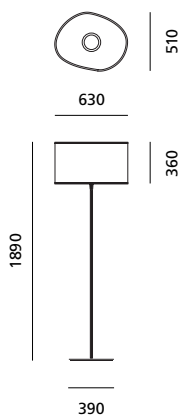

difusor	blanco mate	
POLIETILENO BLANCO MATE / TELA CRUDO	1892000113034	1140,00
POLIETILENO BLANCO MATE / SEDA PINTADA CRUDO	1892000113035	1140,00
POLIETILENO BLANCO MATE / TELA NARANJA	1892000113036	1140,00
POLIETILENO BLANCO MATE / SEDA PINTADA NARANJA	1892000113037	1140,00
POLIETILENO BLANCO MATE / TELA NEGRA	1892000113005	1140,00
POLIETILENO BLANCO MATE / SEDA PINTADA NEGRA	1892000113038	1140,00
POLIETILENO BLANCO MATE / MADERA CHAPADA EN BLANCO	1892000113045	1195,00
POLIETILENO BLANCO MATE / MADERA CHAPADA EN GRIS	1892000113046	1195,00

MAX 1x42W FSMH GX24q-4

mm 2490

ROOM FLUO F5 DIMM

HETTLER/TÜLLMANN, 2009

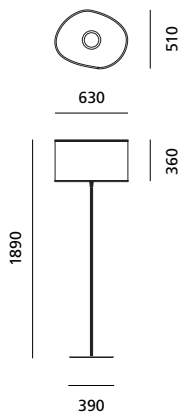

difusor

blanco mate

POLIETILENO BLANCO MATE / TELA CRUDO	1892000213034	1283,00
POLIETILENO BLANCO MATE / SEDA PINTADA CRUDO	1892000213035	1283,00
POLIETILENO BLANCO MATE / TELA NARANJA	1892000213036	1283,00
POLIETILENO BLANCO MATE / SEDA PINTADA NARANJA	1892000213037	1283,00
POLIETILENO BLANCO MATE / TELA NEGRA	1892000213005	1283,00
POLIETILENO BLANCO MATE / SEDA PINTADA NEGRA	1892000213038	1283,00
POLIETILENO BLANCO MATE / MADERA CHAPADA EN BLANCO	1892000213045	1338,00
POLIETILENO BLANCO MATE / MADERA CHAPADA EN GRIS	1892000213046	1338,00

MAX 1x42W FSMH GX24q-4

mm 2490

ROOM F50 (IP20)

HETTLER/TÜLLMANN, 2009

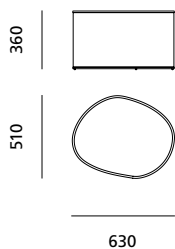

difusor

blanco mate

POLIETILENO BLANCO MATE	1862000213000	461,00
POLIETILENO BLANCO MATE / TELA CRUDO	1862000213034	560,00
POLIETILENO BLANCO MATE / SEDA PINTADA CRUDO	1862000213035	560,00
POLIETILENO BLANCO MATE / TELA NARANJA	1862000213036	560,00
POLIETILENO BLANCO MATE / SEDA PINTADA NARANJA	1862000213037	560,00
POLIETILENO BLANCO MATE / TELA NEGRA	1862000213005	560,00
POLIETILENO BLANCO MATE / SEDA PINTADA NEGRA	1862000213038	560,00
POLIETILENO BLANCO MATE / MADERA CHAPADA EN BLANCO	1862000213045	593,00
POLIETILENO BLANCO MATE / MADERA CHAPADA EN GRIS	1862000213046	593,00

1x23W FBT E27

mm 2800

ROOM FLUO F50 (IP20)

HETTLER/TÜLLMANN, 2009

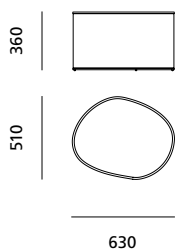

difusor

blanco mate

POLIETILENO BLANCO MATE	1892000313000	516,00
POLIETILENO BLANCO MATE / TELA CRUDO	1892000313034	616,00
POLIETILENO BLANCO MATE / SEDA PINTADA CRUDO	1892000313035	616,00
POLIETILENO BLANCO MATE / TELA NARANJA	1892000313036	616,00
POLIETILENO BLANCO MATE / SEDA PINTADA NARANJA	1892000313037	616,00
POLIETILENO BLANCO MATE / TELA NEGRA	1892000313005	616,00
POLIETILENO BLANCO MATE / SEDA PINTADA NEGRA	1892000313038	616,00
POLIETILENO BLANCO MATE / MADERA CHAPADA EN BLANCO	1892000313045	660,00
POLIETILENO BLANCO MATE / MADERA CHAPADA EN GRIS	1892000313046	660,00

MAX 1x42W FSMH GX24q-4

mm 2800

ROOM F50 (IP44)

HETTLER/TÜLLMANN, 2009

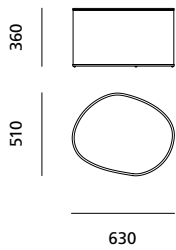

difusor

blanco mate

POLIETILENO BLANCO MATE	1862000313000	483,00
POLIETILENO BLANCO MATE / TELA CRUDO	1862000313034	560,00
POLIETILENO BLANCO MATE / SEDA PINTADA CRUDO	1862000313035	560,00
POLIETILENO BLANCO MATE / TELA NARANJA	1862000313036	560,00
POLIETILENO BLANCO MATE / SEDA PINTADA NARANJA	1862000313037	560,00
POLIETILENO BLANCO MATE / TELA NEGRA	1862000313005	560,00
POLIETILENO BLANCO MATE / SEDA PINTADA NEGRA	1862000313038	560,00



1x23W FBT E27

mm 2800



ROOM FLUO F50 (IP44)

HETTLER/TÜLLMANN, 2009

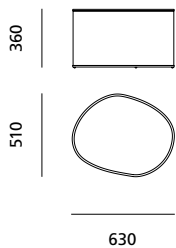

difusor

blanco mate

POLIETILENO BLANCO MATE	1892000513000	516,00
POLIETILENO BLANCO MATE / TELA CRUDO	1892000513034	616,00
POLIETILENO BLANCO MATE / SEDA PINTADA CRUDO	1892000513035	616,00
POLIETILENO BLANCO MATE / TELA NARANJA	1892000513036	616,00
POLIETILENO BLANCO MATE / SEDA PINTADA NARANJA	1892000513037	616,00
POLIETILENO BLANCO MATE / TELA NEGRA	1892000513005	616,00
POLIETILENO BLANCO MATE / SEDA PINTADA NEGRA	1892000513038	616,00



MAX 1x42W FSMH GX24q-4

mm 2800



ROOM F50.FLUO F50

HETTLER/TÜLLMANN, 2009

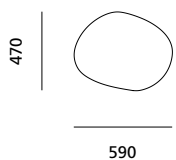

cubierta superior + fieltro

BLANCO	6351000200034	124,00
NARANJA	6351000200036	124,00
NEGRO	6351000200005	124,00



pesos y volúmenes

<i>model</i>	<i>peso (kg)</i>	<i>volumen (m³)</i>	<i>cajas</i>
ABC S1	7,5	0,0952	1
ABC S11	13	0,1884	1
ABC S3	9	0,1749	1
ABC S5	13	0,3119	1
ABC T1	11	0,1643	2
ABC T3	15,8	0,2718	2
ABC F3	20,7	0,2227	3
ABC F5	28,8	0,3864	3
ARGENTUM W3	3,5	0,0166	1
ARGENTUM W4	4,8	0,0415	1
ARGENTUM W7	5,4	0,0305	1
ARGENTUM W9	6,8	0,0639	1
BILUNA F7/PP F7	14,4	0,3119	1
BILUNA F9/PP F9	18,8	0,4396	1
BILUNA S7/PP S7	13,9	0,3119	1
BILUNA S9/PP S9/PP S90	18	0,4396	1
BRIKETT FLOOD C1/W1	1,2	0,0143	1
BRIKETT FLOOD C3/W3	1,7	0,0189	1
BRIKETT FLOOD W12	1,2	0,0143	1
CPL SMALL T1	3	0,0567	2
CPL S1	4,7	0,0609	1
CPL S11	11	0,1200	1
CPL S3	7,4	0,1100	1
CPL S5	10	0,2307	1
CPL S7	10,5	0,1749	1
CPL W1	3,8	0,0480	1
CPL T1	5,2	0,0786	2
CPL T3	5,9	0,0916	2
CPL T5	5,7	0,1045	2
CPL T7	15,1	0,3194	2
CPL T30	8,5	0,1158	2
CPL T31	11,4	0,2102	2
CPL F1	17,1	0,2008	3
CPL F3	22,2	0,3344	3
CPL F7	25,1	0,4829	3
CPL F31	16,9	0,2842	3
CPL MINI W1	1,0	0,0166	1
CPL MINI W3	1,3	0,0182	1
CPL MINI W5	1,5	0,0323	1
DUO FLUO W1	3,35	0,0487	2
DUO FLUO W3	4,8	0,0926	2
EQUILIBRE FLUO/HALO S3/S30	12,5	0,1848	2
EQUILIBRE FLUO/HALO C3/C30	11,7	0,1848	2
EQUILIBRE F3/FLUO F3/F30	43,4	0,2777	4
EQUILIBRE FLUO F33	20,9	0,2547	2
EXTRA S1	6,5	0,0893	2
EXTRA S3	9	0,1242	2
EXTRA C1	6,3	0,0893	2
EXTRA C3	8,8	0,1242	2
FINLAND C1/C1G	1,4	0,0183	1
FINLAND C3/C3G	1,5	0,0216	1
FLOU W5	1,7	0,0236	1
GINGER SMALL T1	3,0	0,0281	2
GINGER S3/S30	3,0	0,0571	1
GINGER S5/S50	3,8	0,0832	1
GINGER S7/S70	5,9	0,134	1
GINGER T3/T30	5,9	0,1263	2
GINGER T5/T50	8,9	0,1830	2

GINGER T7/T70	12,0	0,2718	2
GINGER F3/F30	11,9	0,1578	3
GINGER F5/F50	13,8	0,1908	3
GINGER F7/F70	16,9	0,2559	3
GLAM SMALL T1	2,8	0,0404	1
GLAM SMALL T3	4,4	0,0972	1
GLAM T1	7,6	0,1202	2
GLAM T3	13	0,2059	2
GLAM T5	16,7	0,3095	2
GURU S3	6,0	0,0982	1
LV 33S	8,5	0,2621	1
LV FLUO 33S	9,5	0,2621	1
LV FLUO 34S/34S6	9,5	0,2750	1
LV FLUO 21C/21W	6,5	0,0509	1
LV FLUO 22C/22W	9	0,0951	1
LV FLUO 23C/23W	12	0,1394	1
LV 21W	2,8	0,0509	1
LV 22W	5,5	0,0951	1
LV 21T	2,5	0,0509	1
LV 22T	4,5	0,0951	1
LV 33F	10,3	0,3015	2
LIN W1	0,7	0,0259	1
MINIMA C1	1,7	0,0183	1
MOOD SMALL W3/FLUO W3	3,5	0,0470	2
MOOD W3/FLUO W3	4,6	0,0630	2
NOTTE MT S1	2,3	0,0308	1
NOTTE MT S11	4,0	0,0506	1
NOTTE S3/MT S3	5,7	0,0706	1
NOTTE S33/MT S33	11,5	0,1309	1
NOTTE S5/MT S5	6	0,1100	1
NOTTE FLUO S5	6,5	0,1312	1
NOTTE MT FLUO S5	6,5	0,1100	1
NOTTE S7	12	0,3069	1
NOTTE MT S7	11	0,2679	1
NOTTE FLUO S7/MT FLUO S7	13	0,3069	1
NOTTE PE FLUO S9	12,5	0,5025	1
NOTTE C5/FLUO C5	5,5	0,1100	1
NOTTE FLUO C7	16,5	0,3069	1
OVER S3	5,2	0,0571	1
OVER S33	10,5	0,1063	1
OVER S5	6,1	0,0832	1
POP W1	3	0,0260	1
POP W2/FLUO W2	3,5	0,0343	1
POP FLUO W4	5,5	0,0538	1
QUAD S1	2,8	0,0323	1
QUAD S11	5,5	0,0400	1
QUAD S3	4,2	0,0352	1
QUAD S33	7,6	0,0832	1
ROCK C1/W1	0,95	0,0143	1
ROOM S5/FLUO S5	10,8	0,2079	1
ROOM FLUO F5	30	0,3812	3
ROOM F50/FLUO F50	10,3	0,2079	1
SERA SMALL S1	4,1	0,0664	2
SERA SMALL S11	6,1	0,1117	2
SERA SMALL T1	6,1	0,0856	2
SERA S1	6	0,0869	2
SERA S11	10,8	0,1648	2
SERA S3	9,5	0,1621	2

SERA T1	9,4	0,1348	2
SERA F1	16,4	0,1949	3
SERA F3	24,6	0,3401	3
TECA S1	2,7	0,0223	1
TECA S3	3,1	0,0300	1
TECA S5	3,8	0,0376	1
TECA S7	4,5	0,0453	1
TECA W1	2,2	0,0207	1
TECA W3	2,7	0,0288	1
TECA W5	3,5	0,0370	1
TECA W7	4,2	0,0452	1
TECA T1	14,3	0,0894	1
TECA T12	15	0,1149	1
WORK S3	4,4	0,0480	1
WORK S33	8	0,1309	1
WORK S5	4,9	0,1100	1
WORK FLUO S5	5,5	0,1312	1
WORK C5/FLUO C5	5,5	0,1100	1
ZERO S1G9	1,7	0,0143	1
ZERO S11G9	3,2	0,0447	1
ZERO S3	4	0,0538	1
ZERO S33	7,5	0,1063	1
ZERO S5	5,5	0,0783	1
ZERO S7	7,4	0,1317	1
ZERO FLUO S7	8	0,1788	1
ZERO C1R	2,6	0,0260	1
ZERO C1S	2,9	0,0260	1
ZERO C5/FLUO C5	4,2	0,1100	1
ZERO FLUO C7	8	0,1788	1
ZERO W1G9	1,4	0,0143	1
ZERO W3G9	2	0,0260	1

suggested bulbs

PRODUCT	ORIGINAL LIGHT SOURCE		SUGGESTED ENERGY-SAVINGS BULBS ACCORDING TO 2005/32/EC DIRECTIVE					
		lumen	wattage	socket	product name	brand name	lumen	option dimmerable
ABC S1/S1/T1	150W IAA-HSGST Frosted	2500	23W	E27	LILLIPUT PLUS	MEGAMAN	1500	1 / *
ABC S3/T3/F3	150W IAA-HSGST Frosted	2500	23W	E27	LILLIPUT PLUS	MEGAMAN	1500	1 / *
ABC S5/T5/F5	150W IAA-HSGST Frosted	2500	30W	E27	LILLIPUT PLUS	MEGAMAN	2000	2 / *
ARGENTUM W3	Fluo		26W	G24q-3	DULUX D/E	OSRAM	1800	
ARGENTUM W4	Fluo		2x26W	G24q-3	DULUX D/E	OSRAM	2x1800	
ARGENTUM W7	Fluo		36W	2G11	DULUX L	OSRAM	2900	
ARGENTUM W9	Fluo		55W	2G11	DULUX L	OSRAM	4800	
BILUNA S7/F7	Fluo		55W	2GX13	LUMILUX T5 FC	OSRAM	4200	
BILUNA S9/F9	Fluo		55W	2GX13	LUMILUX T5 FC	OSRAM	4200	
BILUNA S90	Fluo		2x42W	GX24q-4	DULUX T/E	OSRAM	2x3200	
BRIKETT FLOOD C1/W1/W12	60W HDG	840	48W	R7s	HALOLINE ECO	OSRAM	800	
BRIKETT FLOOD C3/W3	100W HDG	1600	80W	R7s	HALOLINE ECO	OSRAM	1520	
CPL SMALL T1	100W IAG/W	1000	20W	E27	LILLIPUT PLUS	MEGAMAN	1300	1 / *
CPL S1/S1/S3/S5	100W IAA Frosted	1340	75W	E27	PAR-ALL.	OSRAM		
CPL S1/S1/S3/S5	150W IAA Frosted	2160	75W/100W	E27	SPOT	OSRAM		
CPL S1/S1/T1/T30/T31/F1/F31	150W IAA Frosted	2160	23W	E27	LILLIPUT PLUS	MEGAMAN	1500	1 / *
CPL S3/T3/F3	150W IAA Frosted	2160	23W	E27	LILLIPUT PLUS	MEGAMAN	1500	1 / *
CPL S5	3x100W IAA Frosted	3x1340	3x16-20W	E27	SOFTONE	PHILIPS	3x870-1160	3 / *
CPL S7/T7/F7	3x60W IAA Frosted	3x710	3x16W	E27	SOFTONE	PHILIPS	3x870	3 / *
CPL W1	100W IAA Frosted	1340	23W	E27	LILLIPUT PLUS	MEGAMAN	1500	1 / *
CPL MINI W1	60W HGST Frosted	790	48W	G9	HALOPIN ECO	OSRAM	740	
CPL MINI W3	60W HGST Frosted	790	48W	G9	HALOPIN ECO	OSRAM	740	
CPL MINI W5	75W HGST Frosted	1050	60W	G9	HALOPIN ECO	OSRAM	980	
DUO FLUO W1	Fluo		2x18W	2G11	DULUX L	OSRAM	2x1200	
DUO FLUO W3	Fluo		2x24W	2G11	DULUX L	OSRAM	2x1800	
EQUILIBRE HALO S3/C3	3x150W HDG	3x2400	3x120W	R7s	HALOLINE ECO	OSRAM	3x2440	
EQUILIBRE F3	500W HDG	9500	400W	R7s	HALOLINE ECO	OSRAM	9200	
EQUILIBRE FLUO S3/C3/F3	Fluo		4x36W	2G11	DULUX L	OSRAM	4x1900	
EQUILIBRE FLUO S30/C30/F30	Fluo		22x40W	2GX13	LUMILUX T5 FC	OSRAM	1800+3000	
EXTRA S1/S3/C1/C3	150W IAA Frosted	2160	20W	E27	SOFTONE	PHILIPS	1160	2 / *
FINLAND C1/C1G	100W IAA Frosted	1340	23W	E27	LILLIPUT PLUS	MEGAMAN	1500	1 / *
FINLAND C3/C3G	100W IAA Frosted	1340	23W	E27	LILLIPUT PLUS	MEGAMAN	1500	1 / *
FLOU W5	100W IAA Frosted	1340	23W	E27	LILLIPUT PLUS	MEGAMAN	1500	1 / *
GINGER SMALL T1	40W HGST Frosted	460	33W	G9	HALOPIN ECO	OSRAM	460	
GINGER S3/T3/F3	2x60W HGST Frosted	2x790	2x48W	G9	HALOPIN ECO	OSRAM	2x740	
GINGER S30/T30/F30	GINGER S5/T5/F5		2x12W	E27	SOFTONE	PHILIPS	2x610	4
GINGER S5/T5/F5	2x75W HGST Frosted	2x1050	2x60W	G9	HALOPIN ECO	OSRAM	2x980	
GINGER S50/T50/F50	GINGER S7/T7/F7		2x12W	E27	SOFTONE	PHILIPS	2x610	4
GINGER S7/T7/F7	2x75W HGST Frosted	2x1050	2x60W	G9	HALOPIN ECO	OSRAM	2x980	
GINGER S70/T70/F70	GINGER S70/T70/F70		2x20W	E27	SOFTONE	PHILIPS	2x1160	3
GLAM SMALL T1	40W HGST Frosted	460	33W	G9	HALOPIN ECO	OSRAM	460	
GLAM SMALL T3	60W HGST Frosted	790	48W	G9	HALOPIN ECO	OSRAM	740	
GLAM T1	3x40W HGST Frosted	3x460	3x33W	G9	HALOPIN ECO	OSRAM	3x460	
GLAM T3	3x60W HGST Frosted	3x790	3x48W	G9	HALOPIN ECO	OSRAM	3x740	
GURU S3	Fluo		55W	2GX13	LUMILUX T5 FC	OSRAM	4200	
LIGHT VOLUME FLUO 21C	Fluo		26W	G24q-3	DULUX D/E	OSRAM	1800	
LIGHT VOLUME FLUO 22C	Fluo		36W	2G11	DULUX L	OSRAM	2900	
LIGHT VOLUME FLUO 23C	Fluo		55W	2G11	DULUX L	OSRAM	4800	
LIGHT VOLUME 33F	Fluo	1340	24W	E27	CIRCOLUX	OSRAM	1700	
LIGHT VOLUME 33S	2x100W IAA Frosted	2x1340	2x24W	E27	CIRCOLUX	OSRAM	2x1700	
LIGHT VOLUME FLUO 33S	Fluo		55W	2G11	DULUX L	OSRAM	4800	
LIGHT VOLUME FLUO 34S	Fluo		55W-80W	2G11	DULUX L	OSRAM	4800-6000	
LIGHT VOLUME FLUO 34S6	Fluo		2x55W	2G11	DULUX L	OSRAM	2x4800	
LIGHT VOLUME 21T	40W IBP Frosted	400	9W	E14	ULTRA COMPACT CLASSIC	MEGAMAN	405	
LIGHT VOLUME 22T	60W IBP Frosted	660	9W	E14	ULTRA COMPACT CLASSIC	MEGAMAN	405	
LIGHT VOLUME FLUO 21W	Fluo		26W	G24q-3	DULUX D/E	OSRAM	1800	
LIGHT VOLUME FLUO 22W	Fluo		36W	2G11	DULUX L	OSRAM	2900	
LIGHT VOLUME FLUO 23W	Fluo		55W	2G11	DULUX L	OSRAM	4800	
MINIMA C1	40W HGST Frosted	460	33W	G9	HALOPIN ECO	OSRAM	460	

MOOD SMALL W3		2x60W IAA Frosted	2x710	2x23W	E27	LILLIPUT PLUS	MEGAMAN	2x1500	2
MOOD SMALL FLUO W3	Fluo			2x26W	G24q-3	DULUX D/E	OSRAM	2x1800	
MOOD W3		2x100W IAA Frosted	2x1340	2x23W	E27	LILLIPUT PLUS	MEGAMAN	2x1500	2 / *
MOOD FLUO W3	Fluo			2x26W	G24q-3	DULUX D/E	OSRAM	2x1800	
NOTTE MT S1				60W	G9	HALOPIN ECO	OSRAM	980	
NOTTE MT S11				2x60W	G9	HALOPIN ECO	OSRAM	2x980	
NOTTE S3/S33/S5/S7/S9		150W IAA Frosted	2400	75W	E27	PAR-ALL.	OSRAM		
NOTTE S3/S33/S5/S7/S9		150W IAA Frosted	2400	75W/100W	E27	SPOT	OSRAM		
NOTTE MT S3/S33/S5/S7		150W IAA Frosted	2400	75W	E27	PAR-ALL.	OSRAM		
NOTTE MT S3/S33/S5/S7		150W IAA Frosted	2400	75W/100W	E27	SPOT	OSRAM		
NOTTE S3/S33		150W IAA Frosted	2400	30W	E27	DULUX INTELLIGENT	OSRAM	1920	2 / *
NOTTE MT S3/S33		150W IAA Frosted	2400	30W	E27	DULUX INTELLIGENT	OSRAM	1920	2 / *
NOTTE T3/F3		150W IAA Frosted	2400	23W	E27	LILLIPUT PLUS	MEGAMAN	1920	1 / *
NOTTE S5		150W IAA Frosted	2400	30W	E27	DULUX INTELLIGENT	OSRAM	1920	2 / *
NOTTE MT S5		150W IAA Frosted	2400	30W	E27	DULUX INTELLIGENT	OSRAM	1920	2 / *
NOTTE FLUO S5	Fluo			42W	G24q-4	DULUX T/E	OSRAM	3200	
NOTTE FLUO MT S5	Fluo			42W	G24q-4	DULUX T/E	OSRAM	3200	
NOTTE T5/F5		150W IAA Frosted	2400	23W	E27	LILLIPUT PLUS	MEGAMAN	1920	1 / *
NOTTE C5		150W IAA Frosted	2400	30W	E27	DULUX INTELLIGENT	OSRAM	1920	2 / *
NOTTE FLUO C5	Fluo			42W	G24q-4	DULUX T/E	OSRAM	3200	
NOTTE S7		150W IAA Frosted	2400	40W	E27	TORNADO HIGH LUMEN	PHILIPS	3000	
NOTTE MT S7		150W IAA Frosted	2400	40W	E27	TORNADO HIGH LUMEN	PHILIPS	3000	
NOTTE FLUO S7	Fluo			2x32W	GX24q-3	DULUX T/E	OSRAM	2x2400	
NOTTE FLUO MT S7	Fluo			2x32W	GX24q-3	DULUX T/E	OSRAM	2x2400	
NOTTE FLUO S9	Fluo			2x32W	GX24q-3	DULUX T/E	OSRAM	2x2400	
OVER S3/S33		100W IAA Frosted	1340	16W	E27	SOFTONE	PHILIPS	870	3 / *
OVER S5		150W IAA Frosted	2400	23W	E27	LILLIPUT PLUS	MEGAMAN	1500	1 / *
PLATONE W1				48W	R7s	HALOLINE ECO	OSRAM	800	
PLATONE FLUO W3	Fluo			36W	2G10	DULUX F	OSRAM	2800	
POP W1		2x60W HGST Frosted	2x790	2x48W	G9	HALOPIN ECO	OSRAM	2x740	
POP W2		2x75W HGST Frosted	2x1050	2x60W	G9	HALOPIN ECO	OSRAM	2x980	
POP FLUO W2	Fluo			32W	GX24q-3	DULUX T/E	OSRAM	2400	
POP FLUO W4	Fluo			42W	GX24q-4	DULUX T/E	OSRAM	3200	
QUAD S1/S11		100W IAA Frosted	1340	30W	E27	DULUX INTELLIGENT	OSRAM	1920	2 / *
QUAD S3/S33		100W IAA Frosted	1340	30W	E27	DULUX INTELLIGENT	OSRAM	1920	2 / *
ROOM FLUO S5/F5/F60	Fluo			32W	G24q-3	DULUX T/E	OSRAM	2400	
ROOM F50				30W	E27	DULUX INTELLIGENT	OSRAM	1920	2
SERA S1/S11/S3/SMALL S1/S11		100W IAA Frosted	1340	75W	E27	PAR-ALL.	OSRAM		
SERA S1/S11/S3/SMALL S1/S11		150W IAA Frosted	2400	75W/100W	E27	SPOT	OSRAM		
SERA SMALL S1/S11/T1		100W IAA Frosted	1340	23W	E27	LILLIPUT PLUS	MEGAMAN	1500	1 / *
SERA S1/S11/T1/F1		150W IAA Frosted	2400	30W	E27	DULUX INTELLIGENT	OSRAM	1920	2 / *
SERA S9/F3		150W IAA Frosted	2400	30W	E27	DULUX INTELLIGENT	OSRAM	1920	2 / *
TECA S1/W1	Fluo			24W	G5	LUMILUX T5	OSRAM	1750	
TECA S9/W3	Fluo			39W	G5	LUMILUX T5	OSRAM	3100	
TECA S5/W5	Fluo			54W	G5	LUMILUX T5	OSRAM	4450	
TECA S7/W7	Fluo			80W	G5	LUMILUX T5	OSRAM	6150	
TECA T1/T12	Fluo			24W	G5	LUMILUX T5	OSRAM	1750	
WORK S3/S33		150W IAA Frosted	2400	30W	E27	DULUX INTELLIGENT	OSRAM	1920	2 / *
WORK S5/C5		150W IAA Frosted	2400	30W	E27	DULUX INTELLIGENT	OSRAM	1920	2 / *
WORK FLUO S9/C5	Fluo			42W	G24q-4	DULUX T/E	OSRAM	3200	*
ZERO C1/R1/C1S		100W IAA Frosted	1340	15W	E27	LILLIPUT PLUS	MEGAMAN	2000	
ZERO S1/G9/S11/G9		75W HGST Frosted	1050	60W	G9	HALOPIN ECO	OSRAM	980	
ZERO S3/S33		150W IAA Frosted	2400	20W	E27	SOFTONE	PHILIPS	1160	3 / *
ZERO S5/C5		150W IAA Frosted	2400	30W	E27	DULUX INTELLIGENT	OSRAM	1920	*
ZERO FLUO C5	Fluo			32W	GX24q-3	DULUX T/E	OSRAM	2400	
ZERO FLUO S7/C7	Fluo			42W	GX24q-4	DULUX T/E	OSRAM	3200	
ZERO W1/G9		60W HGST Frosted	790	48W	G9	HALOPIN ECO	OSRAM	740	
ZERO W9/G9		60W HGST Frosted	790	48W	G9	HALOPIN ECO	OSRAM	740	

wattage	socket	product name	brand name	lumen	Reference
18W	E27	DIMMERABLE	MEGAMAN	1008	1
18W	E27	DULUX INTELLIGENT DIMM.	OSRAM	1050	2
15W	E27	DULUX INTELLIGENT DIMM.	OSRAM	850	3
11W	E27	DIMMERABLE	MEGAMAN	570	4
60W	E27	SPECIAL CENTRA A Frosted	OSRAM	550	*
100W	E27	SPECIAL CENTRA A Frosted	OSRAM	1000	*

Further options: DIMMERABLE

CONDICIONES DE VENTA

- Los precios de esta tarifa se consideran PVP, expresados en Euros.
- El descuento comercial se aplicará sobre el precio que aparece en tarifa. Del importe resultante, se cargará el IVA en factura.
- Todas las entregas superiores a 400,00 € en PVP son a portes pagados hasta cualquier punto de la península.
- En entregas inferiores a 400,00 € en PVP, se cobrará en factura el importe de 20,00 € en concepto de gastos mínimos.
- Formas de pago:
 - Giro a 20 días con 2% de descuento por pronto pago.
 - Giro a 60 días.
- Solo se aceptarán las reclamaciones por rotura que se indiquen en el albarán del transportista en el momento de la descarga o que se notifiquen via fax durante las 24 horas siguientes a la entrega.
- No se aceptarán anulaciones o modificaciones de pedidos transcurridas 48 horas desde la confirmación del mismo.
- Vila Import, S.L. no admitirá devoluciones ni cambios de género que no sean provocados por su responsabilidad. En dicho caso, será necesario la autorización escrita desde nuestra oficina.
- Vila Import, S.L. (PRANDINA) se reserva el derecho de anulación de modelos o acabados sin previo aviso por causas ajenas a su voluntad.
- Esta tarifa anula a las anteriores.
- La formalización de un pedido, implica la aceptación de estas condiciones.