

OUTDOOR

CATALOGO GENERAL
GENERAL CATALOGUE
2010



 LED S.C4



LEDS - C4



LED

Gama de luminarias que han fusionado la tecnología led con el diseño vanguardista, consiguiendo la máxima eficiencia energética, sin renunciar a la estética.

Range of luminaires which have merged led technology with a state-of-the-art design, achieving the maximum energy efficiency, without neglecting aesthetics.



URBAN

Luminarias para alumbrado urbano, tanto de zonas residenciales como de alumbrado vial, con distintas soluciones pensadas para favorecer el ahorro energético y la anticontaminación lumínica.

Luminaires for urban lighting both in residential areas as well as road lighting, with specific solutions designed to promote energy saving and anti-light pollution.

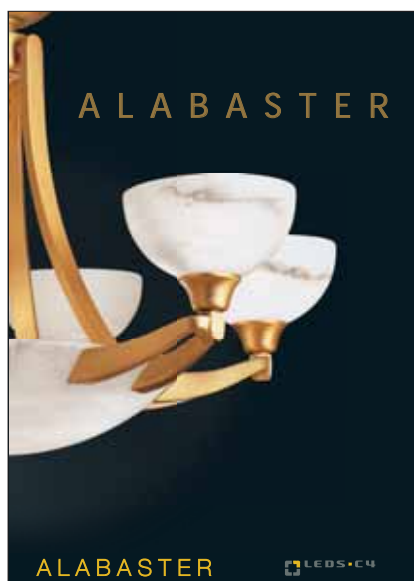

ALABASTER

Luminarias en alabastro tanto de estilo barroco como de estilo contemporáneo. Y aplicaciones lumínico-arquitectónicas (paneles, cornisas y espejos) en alabastro para los ambientes más sofisticados.

Alabaster luminaires both in baroque and contemporary style. And light-architectonic applications (panels, cornices and mirrors) made of alabaster for more sophisticated environments.



LA CREU

Luminarias decorativas con una excelente relación calidad-precio, de todos los estilos: moderno, clásico, tradicional y rústico .. y aptas para distintas aplicaciones: dormitorios, salones, baños, zonas públicas.

Decorative luminaires with an excellent price-quality ratio in all styles: modern, classical, traditional and rustic and suitable for different applications: bedrooms, living rooms, bathrooms and public areas.



GROK

Pura esencia contemporánea: luminarias que resultan obras de arte en sí mismas.

Productos que conjugan a la perfección los conceptos de diseño, calidad e innovación.

Pure contemporary essence: luminaires which are works of art per se.

Products which perfectly combine, design, quality and innovation.



ARCHITECTURAL

Soluciones lumínicas de altas prestaciones para espacios comerciales, oficinas u obras contract.

Producto singular por su calidad, funcionalidad y facilidad de instalación y mantenimiento.

High-performance light solutions for commercial spaces, offices or contract works.

Product which is unique due to its quality, functionality and ease of installation and maintenance.

DIALux

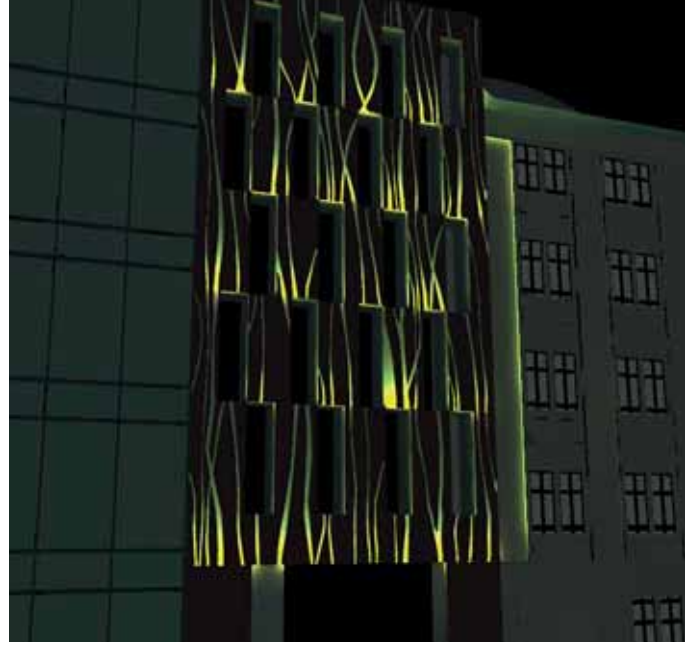

CONSULTORIA DE ILUMINACIÓN – DIALUX

LEDS-C4 dispone de un departamento técnico de proyectos de iluminación destinado a ayudar y asesorar a nuestros clientes sobre cualquier consulta en materia de iluminación. Este departamento está preparado para seleccionar el tipo de iluminación según sus necesidades y la funcionalidad de la zona. Asimismo, puede asesorarle sobre la mejor distribución de la intensidad de la luz. Además, LEDS-C4 ofrece a sus clientes la posibilidad de trabajar con DIALux, el software líder en planificación de iluminación, que utilizan más de 30.000 proyectistas y lighting designers de todo el mundo.

LIGHTING CONSULTANCY – DIALUX

LEDS-C4 has a technical department for lighting projects, with the aim to help and advise our clients about any questions they may have about lighting. This department is equipped to select the type of lighting according to your needs and the functionality of the area. It can also advise you on the best distribution of the light intensity. LEDS-C4 also offers its clients the possibility of working with DIALux, the leading software in lighting planning, with more than 30,000 draftspeople and lighting designers from all over the world.

LE CONSEIL EN ILLUMINATION – DIALUX

LEDS-C4 dispose d'un département technique de projets d'illumination destiné à aider et conseiller nos clients en matière d'illumination. Ce département est capable de choisir, avec vous, le meilleur type d'éclairage en fonction des vos besoins et des fonctionnalités de la zone en question. Ainsi, nous pouvons vous conseiller sur la meilleure distribution et intensité de la lumière. De plus, LEDS-C4 offre à ses clients la possibilité de travailler avec DIALux, le logiciel leader en études et simulations d'éclairage, utilisé par plus de 30.000 designers et concepteurs lumière du monde entier.

CONSULENZA DI ILLUMINAZIONE – DIALUX

LEDS-C4 dispone di un reparto tecnico di progetti di illuminazione destinato ad aiutare e consigliare i nostri clienti per qualsiasi problema in fatto di illuminazione. Questo reparto è preparato per selezionare il tipo di illuminazione a seconda delle necessità del cliente e la funzionalità della zona. Al tempo stesso, il cliente potrà essere consigliato in quanto alla distribuzione ottimale dell'intensità luminosa.

Inoltre, LEDS-C4 offre ai suoi clienti la possibilità di lavorare con DIALux, il software leader in pianificazione di illuminazione, utilizzato da oltre 30.000 progettisti e lighting designer di tutto il mondo.

ABTEILUNG FÜR BELEUCHTUNGSBERATUNG – DIALUX

LEDS-C4 stellt den Kunden eine Abteilung zur technischen Beratung für Beleuchtungsprojekte zur Verfügung, die bezüglich jeder Angelegenheit im Zusammenhang mit der Beleuchtung Rat und Auskunft erteilt. Diese Abteilung ist Ihnen bei der Auswahl der Beleuchtungsart behilflich, die sich am besten an Ihre Bedürfnisse anpasst und die höchste Funktionalität im jeweiligen Einsatzbereich bietet. Darüber hinaus kann Sie diese Abteilung bezüglich der günstigsten räumlichen Lichtstärkeverteilung beraten.

LEDS-C4 bietet den Kunden überdies die Möglichkeit, mit DIALux zu arbeiten, der im Bereich der Beleuchtungsplanung marktführenden Software, die von über 30.000 Projekttechnikern und Beleuchtungsdesignern der ganzen Welt benutzt wird.

CONSULTORIA DE ILUMINAÇÃO – DIALUX

A LEDS-C4 dispõe de um departamento técnico de projectos de iluminação destinado a ajudar e a prestar assessoria aos nossos clientes para qualquer consulta em matéria de iluminação. Este departamento está preparado para seleccionar o tipo de iluminação de acordo com as suas necessidades e a funcionalidade da zona. De igual modo, pode prestar-lhe assessoria para a melhor distribuição da intensidade da luz.

Além disso, a LEDS-C4 oferece aos seus clientes a possibilidade de trabalharem com o DIALux, o software líder em planificação de iluminação, que é utilizado por mais de 30.000 projectistas e lighting designers de todo o mundo.

							
AFRODITA.....49,51,53	AJAX.....37,39	ALEXANDRIA.....169, 171	ALBA.....191	ALFA.....13	ALIEN.....71		
							
ANTEO.....217	AQUA.....109	ARIADNA.....150	ARMONIA.....149	ATENA.....43	ATLANTE.....237	ATLANTIDA.....227	
							
BETA.....21	CIRI.....199	CROSS.....195	CURIE.....31	DARWIN.....27	ECLIPSE.....41	EDIPO.....209	ELECTRA.....141, 143
							
EOLO.....72	ESPARTA.....75	FENIX.....57	FLASH.....77	GALATEA.....229, 231	GALILEI.....35	GRID.....201, 202	
							
HADES.....220	HEBE.....173	HECATE.....85	HELIO.....73	HERA.....203	HERCULES.....45	HERMES.....147	HUBBLE.....65
							
ICARO.....165	IRIS.....222	ITACA.....213	IXION.....175	JANNA.....187	MARK.....179	MARTE.....215	MEDEA.....211
							
MICENAS.....19	MIMER.....153	MORFEO.....219	NEMESIS.....55	NEREO.....146	OCEANO.....224	O'COLOR.....69	ODISEO.....205
							
OLIMPO.....233	PERSEFONE.....207	PERSEO.....225	POMPEYA.....81	POSIDO.....220	PRIAP.....127	REED.....197	SELENE.....157, 159



SIRENA.....221 SKADE.....72 SOFT.....163 TEMIS.....76 TRITON.....223 VULCANO.....44 WINDOWS29 ZEUS.....42

PLAFON / CEILING FIXTURE / PLAFONNIER / DECKENLEUCHE / PLAFONIER / LUMINÁRIA DE TECTO



AFRODITA.....53 ALBA.....193 ARES.....154 ARIADNA.....150 COSMOS.....61 ECLIPSE.....41 SOFT.....163



IDUN.....152 IRENE.....154 MARK.....181 PEGASO.....148 PERGOLA.....155 SELENE.....159 VIDAR.....151

COLGANTE / PENDANT / SUSPENSION / PENDELLEUCHE / LAMPADA A SOSPENSIONE / LUMINÁRIA PARA SUSPENSÃO



ALBA.....191 ANTEO.....217 CROSS.....195 EDIPO.....209 GALATEA.....229 GRID.....201, 202



ITACA.....213 JANNA.....187 MARK.....179 MORFEO.....219 ODISEO.....205 OLIMPO.....233 PERSEFONE.....207

SOBREMURO / LANTERN / LANTERNE / MAUERLEUCHE / LAMPADA DI MURO / SOBREMURO



ALBA.....193 ALEXANDRIA.....169, 171 ANTEO.....217 CROSS.....195 CUBIK.....119 EDIPO.....210 ELECTRA.....141, 143



GALATEA.....229,231 GRID.....201 ITACA.....214 IXION.....175 JANNA.....187 MARK.....181, 183 MIDAS.....134



MORFEO.....219 ODIN.....120 ODISEO.....205 OLIMPO.....233 PERSEFONE.....207 REED.....197 URANO.....136

BALIZA / BEACON / BALISE / STEHLEUCHTE / PALETTI / LUMINÁRIA PARA BALIZAGEM



ALBA.....193 ALEXANDRIA.....169, 171 BALIZAS.....131 BALIZAS.....133 BALIZAS.....134 BRIDGE.....121 CROSS.....195 EDIPO.....210



ELECTRA.....141, 143 HEBE.....173 ICARO.....165 ITACA.....214 IXION.....175 MARK.....183 MERCURIO.....137 MICENAS.....135



NOTT.....127 POMPEYA.....83 PRIAP.....145 QUADRA.....125 URANO.....136 SOFT.....163

EMPOTRABLE / EMBEDDED / À ENCASTRER / EINBAULEUCHTEN / ENCASTRABLE / ENCASTRAVEL



AQUA.....107,109 BETA.....21 GEA.....91 GEA.....89 GEA.....93-103



HERCULES.....23 MICENAS.....17,19 XENA.....113, 115

PROYECTOR / PROJECTOR / PROJECTEUR / STRAHLER / PROIETTORE / PROJECTOR



ALIEN..... 71 AQUA..... 109 ESPARTA 75 FLASH.....77 HELIO.....73
 HUBBLE.....65 ICARO.....165 O'COLOR.....69 SKADE.....72



ATLANTE.....237 ANDALUCIA.....255 BOHEMIA.....256 CITIZEN.....255 ELIPSE.....257 GALATEA.....231 GAVINA.....256 HEADS.....247,249 MAXI FLOOD.....254

Índice-Index



MERIDIAN.....256 OLIMPO.....235 PERSEFONE.....207 POMPEYA.....82 PROMENADE.....257 PROMENADE LED.....257 ROADWAY.....255 TEMIS.....252,253 UMA.....254

OTROS / OTHERS / AUTRES / ANDERE / ALTRI / OUTROS



CISNE.....242 CUBIK.....241 LINTERNA FLUORESCENTE
FLUORESCENT LANTERN.....259 MOIRA.....239

ACCESORIOS / ACCESSORIES



ANTI-CONTAMINACIÓN LUMÍNICA
ANTI-LIGHT POLLUTION.....246 KIT VSAP/HM
HPS/MH KIT.....246 CAJA DE CONEXIONES
CONNECTION BOX.....243, 258 CAJA PARA EMPOTRAR
FLUSH FITTING BOX.....259 CONECTOR IP 68
IP 68 CONNECTION..... 259



CONTRAPESO PARA FAROLAS.
BALANCING WEIGHT FOR LAMPOSTS.....159



REACTANCIA
ELECTRONIC BALLAST.....259



TRANSFORMADOR
TRANSFORMER.....258



ACCESORIO PARA AUGMENTO HASTA IP65
ACCESSORY TO INCREASE UP TO IP 65.....259



Alfa COLLECTION 

- Colección de apliques realizada en dos acabados: acero inoxidable y rústico. Dos modelos que permiten el montaje en superficie ocupando el mínimo espacio.
- A collection of wall fixtures with two different finishes: stainless steel and rustic. Two models enable surface mounting while taking up a minimum amount of space.
- Une collection d'appliques disponibles en deux finitions, acier inoxydable et rustique. Deux modèles qui peuvent être installés en surface et qui occupent un minimum de place.
- Eine Kollektion von Wandleuchten in zwei Ausfertigungsarten aus rostfreiem Stahl und rustikal. Zwei Modelle, die auf sehr begrenztem Raum montiert werden können.
- Collezione di applique realizzate in due finiture: acciaio inossidabile e rustico. Due che consentono il montaggio in superficie, occupando uno spazio minimo.
- Coleção de apliques feita com dois acabamentos: aço inoxidável e rústico. Dois modelos que permitem a montagem em superfície ocupando um espaço mínimo.

 Registration number: Pending





Materiales / Materials



MONTAJE EN SUPERFICIE
SURFACE MOUNTED

Especificaciones / Specifications



Acabados / Finishes

J6	Marrón Brown Marron Braun Marrone Castanho	Y4	Acero inoxidable Stainless steel Acier inoxydable Rostfreier Stahl Acciaio inossidabile Aço inoxidável
----	---	----	---

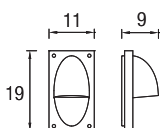

05-9344-J6-T2 ■ ALU
05-9344-Y4-T2 ■ INOX

- GU-10 max. 50W
- GU-10 max. 9W Fluorescent
- GU-10 max. 5W LED

IP 54 6 IK 07

OSRAM 50W **Included**

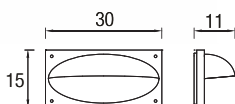
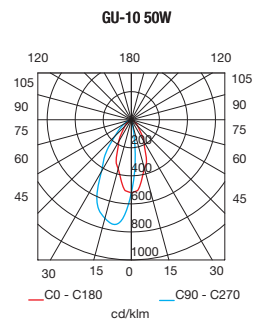

05-9345-J6-T2 ■ ALU
05-9345-Y4-T2 ■ INOX

G24d-3 26W fluorescent

IP 54 4 IK 07

Included

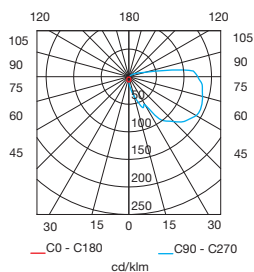

MUY IMPORTANTE consulte la tabla de usos y mantenimiento en la página 274
VERY IMPORTANT please consult the table on use and maintenance on page 274
TRÈS IMPORTANT consultez la table d'utilisation et de maintenance de la page 274

WICHTIG Bitte beachten Sie die Tabelle der Gebrauchs- und Instandhaltungsanweisungen auf Seite 274
MOLTO IMPORTANTE si consulti la tabella di uso e manutenzione a pagina 274
MUITO IMPORTANTE consulte a tabela de uso e manutenção na página 274



Micenas COLLECTION [®]

- Colección de bañadores de suelo empotrables y de superficie con gran variedad de tamaños y formas realizados en aluminio inyectado. La colección se completa con una baliza. Los modelos están especialmente indicados para la señalización de zonas de paso. Además, están disponibles para utilizar con lámparas fluorescentes, halógenos y LED.
- A collection of built-in floor and surface wash lights in a large variety of shapes and sizes, made of die-cast aluminium. The collection is completed with a beacon. The models are specially designed to indicate paths. They are also available to be used with fluorescent, halide and LED lamps.
- Une collection de luminaires de sol encastrables et de surface disposant d'une grande variété de tailles et de formes, en aluminium injecté. La collection est complétée par une balise. Les modèles sont particulièrement indiqués pour la signalisation de chemins et zones piétonnes. Ils permettent, de plus, l'utilisation de lampes fluorescentes, halogénures et LED.
- Eine Kollektion von Lichtdiffusoren, die in Böden und Wänden eingebaut werden können, bestehend aus einer umfangreichen Auswahl an Größen und Formen, hergestellt aus gespritztem Aluminium. Die Kollektion wird durch eine Leuchtbake vervollständigt. Die Modelle eignen sich besonders zur Markierung von Durchgangszonen. Sie sind ebenfalls für die Benutzung von Leuchtstoff-, Halogendampf- und LED-Lampen geeignet.
- Collezione di elementi bagnabili da suolo, a incasso e di superficie, dalla grande varietà di dimensioni e forme, realizzati in alluminio iniettato. La collezione è completata da un faretto. I modelli sono particolarmente indicati per la segnalazione di zone di passaggio. Inoltre, possono essere utilizzati con lampade a fluorescenza, ad alogenuri e LED.
- Coleção de bases de duche de solo encastráveis e de superfície com uma grande variedade de tamanhos e formas feitas em alumínio injetado. A coleção é completada com sinalização. Os modelos são especialmente indicados para a sinalização de zonas de passagem. Além disso, estão disponíveis com lâmpadas fluorescentes, halogenetos e LED.

[®] Registration number: Pending





Materiales / Materials



Incluido / Included



Especificaciones / Specifications



Acabados / Finishes

- 34 Gris / Grey / Gris / Grau / Grigio / Cinzento
- Z5 Gris urbano / Urban grey / Gris urbain / Stadtgrau / Grigio urbano / Cinzento urbano

(new)

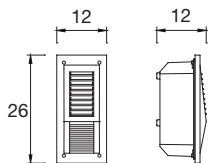

05-9407-34-B8 ■

G24d-3 26W fluorescent

IP 54 4 260 IK 04

BAG Included

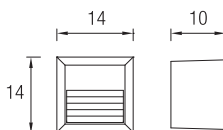
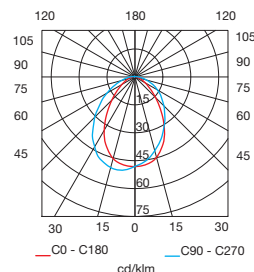

05-9169-34-37 ■

18 LEDs x 0,1 W 1,8W-230V.

IP 65 6 260 IK 04

Included

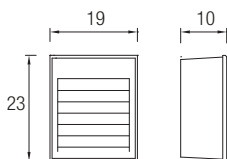
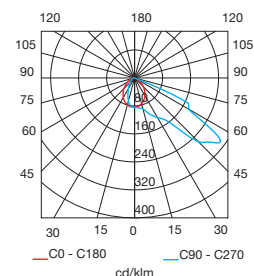

05-9240-34-37 ■

27 LEDs x 0,1 W 2,7W-230V

IP 65 4 260 IK 04

Included

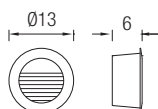
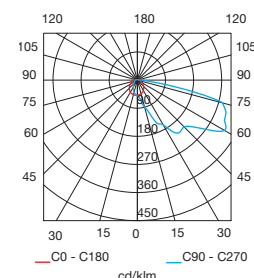

05-9167-34-37 ■

14 LEDs x 0,1 W 1,4W-230V

IP 65 6 260 IK 04

Included

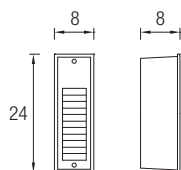
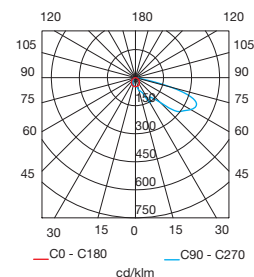

05-9128-34-T2 ■

G9 max. 60W

IP 44 6 260 IK 04

40W OSRAM Included

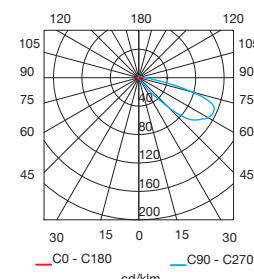



Características / Specifications



Especificaciones / Specifications



Acabados / Finishes

- 34 Gris Grey
- Gris Urban grey
- Grau Stadtgrau
- Grigio Grigio urbano
- Cinzento Cinzento urbano

- Z5 Gris urbano Urban grey
- Gris urbain Stadtgrau
- Grigio urbano Grigio urbano
- Cinzento urbano Cinzento urbano

(new)

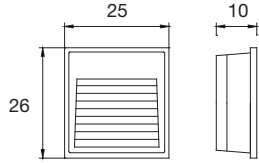

05-9434-34-T2 ■

G24d-3 26W fluorescent

IP 54 2 261 IK 04

BAG Included

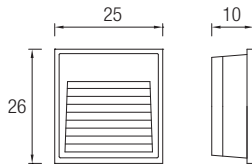
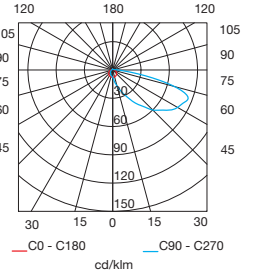

05-9388-34-T2 ■

G12 35W Halogenurs

IP 54 2 261 IK 04

BAG Included

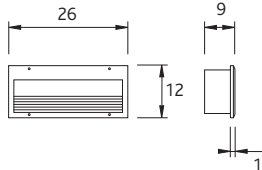
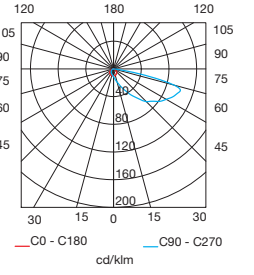

05-9179-34-B8 ■

05-9179-Z5-B8 ■

G24d-3 26W fluorescent

IP 44 6 260 IK 04

BAG / VOSSLOH Included

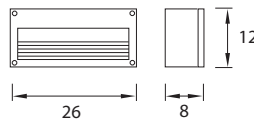
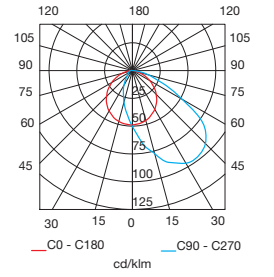

05-9315-34-B8 ■

05-9315-Z5-B8 ■

G24d-3 26W fluorescent

IP 44 6 IK 04

BAG / VOSSLOH Included

Montaje en superficie
Surface mounted

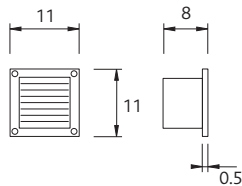
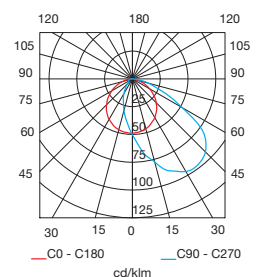

05-9182-34-B8 ■

G9 max. 40W

IP 65 6 260 IK 04

40W OSRAM + Dos frontales / Two frames Included



con rejilla
with grid

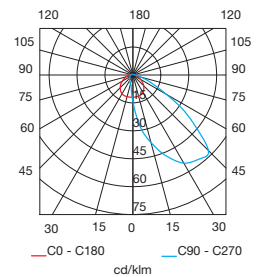

BETA



Beta COLLECTION ®

- Elegante colección de baja contaminación lumínica integrada por un empotrable y un aplique de colocación en superficie, ambos en dos acabados diferentes. Los modelos se presentan con equipos fluorescentes incluidos. Una serie pensada para favorecer el ahorro de energía.
- An elegant collection that produces low light pollution. It is made of an embedded and a wall fixture to place on surfaces, with two different finishes. The models come with built-in fluorescent equipment. This series is aimed at saving energy.
- Une élégante collection à pollution lumineuse réduite, composée d'un modèle encastrable et d'une applique de montage en surface, tous les deux avec deux finitions différentes. Les modèles comprennent des équipements fluorescents. Une série conçue pour favoriser l'économie d'énergie.
- Eine elegante Kollektion von Modellen, die nur eine sehr niedrige Lichtverschmutzung verursachen. Sie besteht schließen die Leuchtstoff-Anlagen ein. Beide werden in verschiedenen Ausführungsarten angeboten. Die Modelle schließen die magnetischen Anlagen ein. Eine Modellserie, die dazu beiträgt, Energie einzusparen.
- Elegante collezione a basso inquinamento luminoso, integrata da un faretto da incasso e da un faretto da montare in superficie, entrambi con due diverse finiture. I modelli sono provvisti di a fluorescenza. Una serie pensata per favorire il risparmio energetico.
- Elegante coleção de baixa contaminação luminosa, composta por um encastrável e um aplique de colocação em superfície, ambos com dois acabamentos diferentes. Os modelos são fornecidos com equipamentos fluorescentes incluídos. Uma série pensada para proporcionar a poupança de energia.

® Registration number: 001091375-025



Materiales / Materials



Incluido / Included



Especificaciones / Specifications



34 Gris
Grey
Gris
Grau
Grigio
Cinzeno

Z5 Gris urbano
Urban grey
Gris urbain
Stadtgrau
Grigio urbano
Cinzeno urbano

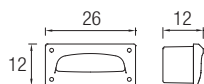

05-9346-34-B8 ■

05-9346-Z5-B8 ■

G24d-3 26W fluorescent

IP 54

BAG Included

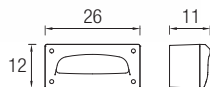
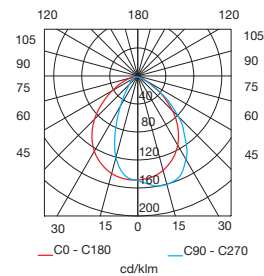

05-9347-34-B8 ■

05-9347-Z5-B8 ■

G24d-3 26W fluorescent

IP 54

BAG Included

Montaje en superficie
Surface mounted

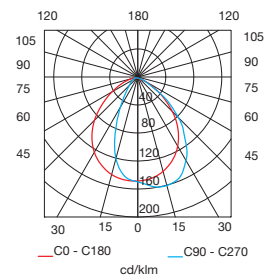

HERCULES



Hercules COLLECTION

- Colección de empotrables de pared y apliques de superficie, con gran variedad de tamaños y formas realizados en aluminio inyectado. Los modelos, especialmente indicados para la señalización de zonas de paso, están disponibles con lámparas fluorescentes.
- A collection of built-in wall luminaires and surface wall fixtures, in a wide variety of shapes and sizes, made of die-cast aluminium. The models are specially designed for indicating paths, and they are available with fluorescent.
- Une collection de luminaires encastrables muraux et appliques de surface avec une grande variété de tailles et de formes, en aluminium injecté. Les modèles, particulièrement indiqués pour la signalisation de chemins et zones piétonnes, sont également disponibles avec des lampes fluorescentes.
- Eine Kollektion von Wandeinbau- und Wandaufsatzleuchten in vielfältigen Größen und Formen, die aus eingespritztem Aluminium hergestellt werden. Die Modelle, die sich besonders zur Markierung in Durchgangszonen eignen, sind mit Leuchtstofflampen erhältlich.
- Collezione di elementi a incasso da parete e applique di superficie dalla grande varietà di dimensioni e forme realizzate in alluminio iniettato. I modelli, particolarmente indicati per la segnalazione di zone di passaggio, sono disponibili con lampade fluorescenti.
- Colecção de encastráveis de parede e apliques de superfície com uma grande variedade de tamanhos e formas feitos em alumínio injectado. Os modelos, especialmente indicados para a sinalização de zonas de passagem, estão disponíveis com lâmpadas fluorescentes.



MUY IMPORTANTE consulte la tabla de usos y mantenimiento en la página 274
VERY IMPORTANT please consult the table on use and maintenance on page 274
TRÈS IMPORTANT consultez la table d'utilisation et de maintenance de la page 274

WICHTIG Bitte beachten Sie die Tabelle der Gebrauchs- und Instandhaltungsanweisungen auf Seite 274
MOLTO IMPORTANTE si consulti la tabella di uso e manutenzione a pagina 274
MUITO IMPORTANTE consulte a tabela de uso e manutenção na página 274

Características / Specifications



Incluido / Included



Especificaciones / Specifications



Acabados / Finishes

05 Negro Black Noir Schwarz Nero Preto	14 Blanco White Blanc Weiß Bianco Branco	34 Gris Grey Gris Grau Grigio Cinzentu	Y4 Acero inoxidable Stainless steel Acier inoxydable Rostfreier Stahl Acciaio inossidabile Aço inoxidável
---	---	---	--

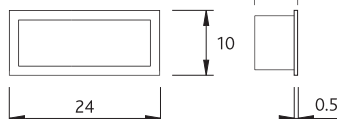

05-9211-Y4-T2

PL elect. E-27 20W - GE

E-27 ø45 max. 60W

IP 44 18 260

set completo para uso con / complete set to use with PL G24d-1

05-9211-Y4-T2 + 71-8969-00-00

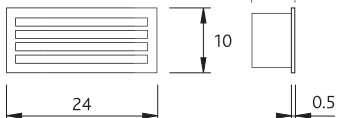
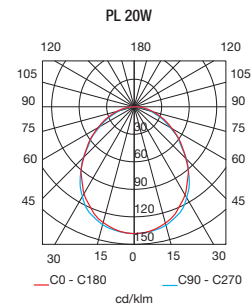

05-9212-Y4-T2

PL elect. E-27 20W - GE

E-27 ø45 max. 60W

IP 44 18 260

set completo para uso con / complete set to use with PL G24d-1

05-9212-Y4-T2 + 71-8969-00-00

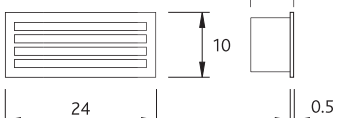
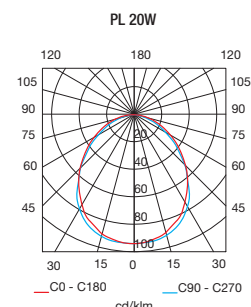

05-8759-05-B8

05-8759-14-B8

05-8759-34-B8

PL elect. E-27 20W - GE

E-27 ø45 max. 60W

IP 44 18 260

set completo para uso con / complete set to use with PL G24d-1

05-8759 + 71-8969-00-00

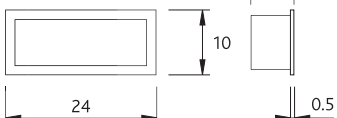
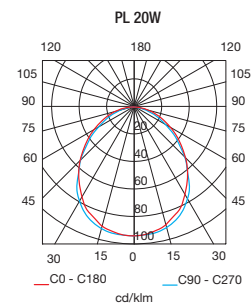

05-8961-05-B8

05-8961-14-B8

05-8961-34-B8

PL elect. E-27 20W - GE

E-27 ø45 max. 60W

IP 44 18 260

set completo para uso con / complete set to use with PL G24d-1

05-8961 + 71-8969-00-00

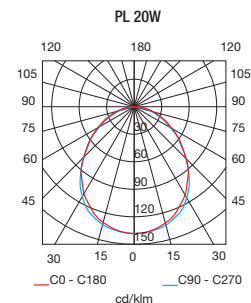

71-8969-00-00

Reactancia para PL G24d-1 13W
Electronic ballast for PL G24d-1 13W



Darwin COLLECTION

- Luminaria polivalente para uso en pared o techo. Cuerpo y difusor de policarbonato, por lo que resulta idóneo para instalación en zonas con alto riesgo de corrosión. Se puede complementar con accesorio embellecedor. Especialmente dimensionado para uso de lámparas de bajo consumo.
- Multi-purpose light for use on walls or ceilings. Body and diffuser made of polycarbonate, making it ideal for installation in areas with a high risk of corrosion. It can be complemented with a decorative accessory. Specially designed to use low energy lights.
- Lampe polyvalente pour mur ou plafond. Corps et diffuseur en polycarbonate qui en font une lampe idéale pour être installée dans des zones à haut risque de corrosion. Peut être complétée par un accessoire enjoliveur. Spécialement dimensionnée pour l'utilisation d'ampoules à économie d'énergie.
- Mehrzwecklampe für Wand- oder Deckenmontage. Körper und Diffusor aus Polycarbonat, weshalb sich die Lampe hervorragend für die Montage an Orten mit hohem Verschleißrisiko eignet. Sie kann mit einer Zierkappe ergänzt werden. Besonders für die Verwendung von Energiesparlampen ausgerüstet.
- Lampada polivalente per installazione a parete o a soffitto. Corpo e diffusore in policarbonato, idoneo per l'installazione in zone ad alto rischio di corrosione. Si può integrare con accessorio decorativo. Disegnato in modo che possano essere usate lampadine a basso consumo.
- Luminária polivalente para aplicação em parede ou tecto. Corpo e difusor em policarbonato, pelo que pode ser instalada em zonas onde exista alto risco de corrosão. Pode-se complementar com acessório embelezador. Especialmente dimensionada para uso de lâmpadas de baixo consumo.

 Registration number: Pending





Materiales / Materials

PC

Especificaciones / Specifications



IP 54 ENERGY SAVING IK 08

Acabados / Finishes

■ Z5 Gris urbano
Urban grey
Gris urbain
Stadtgrau
Grigio urbano
Cinzeno urbano

(new)

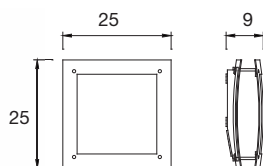

05-9444-Z5-M3 ■

PL elect. E-27 max. 23W

IP 54 6 ENERGY SAVING IK 08

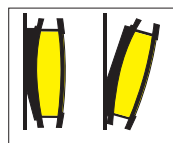

2 posiciones de instalación.
2 installation positions.
2 positions d'installation.
2 Stellungen zur Installation (Einbaustellungen).
2 posizione d'installazione
2 posições de instalação.

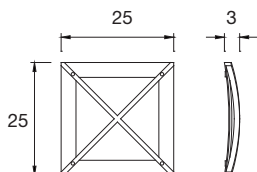

71-9445-Z5-Z5

6

Accesorio para 05-9444
Accessory for 05-9444

WINDOWS

Windows COLLECTION

- Luminaria realizada en aluminio de alta calidad y con difusor de cristal satinado. Equipo de bajo consumo integrado.
- Light fitting made from high quality aluminium with satin glass diffuser. Integrated energy saving equipment.
- Luminaires réalisés en aluminium de haute qualité avec un diffuseur en verre satiné. Équipement à économie d'énergie intégré.
- Leuchte, die aus hochwertigem Aluminium hergestellt und mit einem Diffusor aus satiniertem Glas ausgestattet ist. Integriertes Energiesparsystem.
- Lampada realizzata in alluminio di alta qualità e con diffusore in cristallo satinato. Gruppo a basso consumo integrato.
- Luminária concebida feito em alumínio de alta qualidade e com difusor em vidro acetinado. Equipamento para baixo consumo integrado.

 Registration number: Pending



Materiales / Materials



Especificaciones / Specifications



Acabados / Finishes

- Z5 Gris urbano
- Urban grey
- Gris urbain
- Stadtgrau
- Grigio urbano
- Cinzeno urbano

(new)

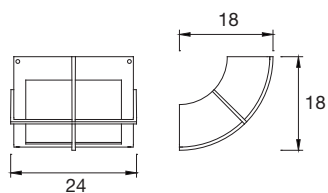

05-9410-Z5-B8 ■

GX24d-3 26W Fluorescent

IP 44 4 IK 04

Included

CURIE

Curie COLLECTION [®]

- Luminária realizada en aluminio de alta calidad y con difusor de policarbonato. Disponible en dos acabados diferentes de gris. Equipo de bajo consumo integrado.
- Light fitting made from high quality aluminium with a polycarbonate diffuser. Available in two different grey finishes. Integrated energy saving equipment.
- Luminaire réalisé en aluminium de haute qualité avec un diffuseur en polycarbonate. Disponible dans deux finitions différentes de gris. Équipement à économie d'énergie intégré.
- Leuchte, die aus hochwertigem Aluminium hergestellt und mit einem Diffusor aus satiniertem Glas ausgestattet ist. Erhältlich in zwei verschiedenen Ausfertigungen in Grau. Integriertes Energiesparsystem.
- Lampada realizzata in alluminio di alta qualità e con diffusore in policarbonato. Disponibile in due finiture grigie differenti. Gruppo a basso consumo integrato.
- Luminária concebida feito em alumínio de alta qualidade e com difusor em policarbonato. Disponível com dois acabamentos diferentes em cinzento. Equipamento para baixo consumo integrado.

[®] Registration number: Pending



Materiales / Materials



Especificaciones / Specifications



Acabados / Finishes

■ 34 Gris	■ Z5 Gris urbano
Grey	Urban grey
Gris	Gris urbain
Grau	Stadtgrau
Grigio	Grigio urbano
Cinzeno	Cinzeno urbano

(new)



05-9408-34-M3 ■
05-9408-Z5-M3 ■

G24d-3 26W fluorescent

IP 65 4 IK 09

Included

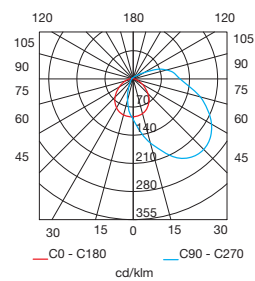
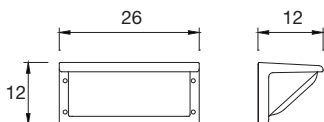



Galilei COLLECTION [®]

- Apliques con cuerpo y difusor de policarbonato, por lo que resultan idóneos para instalación en zonas con alto riesgo de corrosión. Serie formada por dos modelos de applique, especialmente dimensionados para uso de lámparas de bajo consumo.
- Fittings with body and diffuser made of polycarbonate, making them ideal for installation in areas with a high risk of corrosion. Range includes two models of fitting, specially designed for use with energy saving lamps.
- Appliques avec corps et diffuseur en polycarbonate, idéales pour être installées dans des zones à haut risque de corrosion. Série comprenant deux modèles d'appliques, spécialement dimensionnés pour l'utilisation d'ampoules à économie d'énergie.
- Wandleuchten mit Körper und Diffusor aus Polycarbonat, weshalb sie sich ausgezeichnet für die Montage an Orten mit hohem Verschleißrisiko eignen. Eine Serie, die aus zwei Wandlampenmodellen besteht und besonders für die Verwendung von Energiesparlampen ausgerüstet ist.
- Applique con corpo e diffusore in policarbonato, idonea per l'installazione in zone ad alto rischio di corrosione. Serie formata da due modelli di applique, disegnati in modo che si possano utilizzare lampadine a basso consumo.
- Apliques com corpo e difusor em policarbonato, pelo que podem ser instalados em zonas com alto risco de corrosão. Série composta por dois modelos de applique, especialmente dimensionados para o uso de lâmpadas de baixo consumo.

[®] Registration number: Pending





Materiales / Materials

PC

Especificaciones / Specifications

□ F CE RF 850° ENERGY SAVING IP 54 IK 08

Acabados / Finishes

■ 34 Gris Grey Gris Grau Grigio Cinzeno	■ Z5 Gris urbano Urban grey Gris urbain Stadtgrau Grigio urbano Cinzeno urbano
--	---

(new)

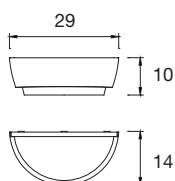

05-9409-34-M3 ■
05-9409-Z5-M3 ■

PL elect. E-27 max. 23W

IP 54 10 IK 08

(new)

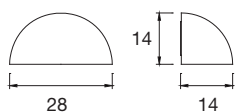

05-9415-Z5-M3 ■

PL elect. E-27 max. 23W

IP 54 6 IK 08

Ajax COLLECTION [®]

- Serie formada por una gran variedad de apliques contemporáneos realizados en acero inoxidable y con difusor en policarbonato. Uno de los modelos incorpora un sensor de movimiento a la luminaria.
- A collection that includes a wide range of contemporary wall fixtures, made of stainless steel and with a polycarbonate diffuser. One of the models comes with a movement sensor on the luminaire.
- Une série composée d'une grande variété de lampes appliques contemporaines en acier inoxydable avec diffuseur en polycarbonate. Un des modèles comprend un senseur de mouvement.
- Eine Produktserie, bestehend aus einer großen Vielfalt von modernen Wandleuchten, die aus rostfreiem Stahl hergestellt sind und über einen Diffusor aus Polykarbonat verfügen. In einem der Modelle ist ein Bewegungssensor eingebaut.
- Serie formata da una grande varietà di applique dal design contemporaneo realizzate in acciaio inossidabile e con diffusore in policarbonato. Uno dei modelli incorpora alla luminaria un sensore di movimento.
- Série composta por uma grande variedade de apliques contemporâneos feitos em aço inoxidável e com difusor em policarbonato. Um dos modelos incorpora um sensor de movimento no aparelho de iluminação.

[®] Registration number: 000835277-0035 / 001091375-023 / 001091375-024 / 000504063-0012





Materiales / Materials



Especificaciones / Specifications



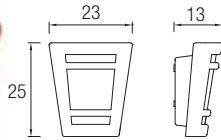

Acabados / Finishes

 AW Terracota Clay backed Terre cuite Terracotta Terracotta Terracota	 J6 Marrón Bown Marron Braun Marrone Castanho
---	---



05-9372-AW-M3 ■

-  E-27 max. 60W
-  PL elect. E-27 max. 30W

IP 54   6 



 **18W Included**

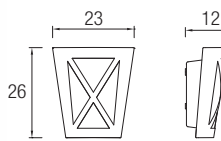
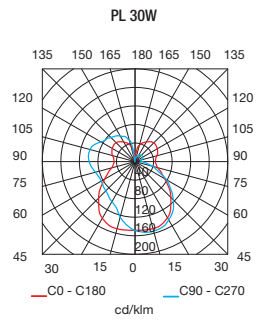

Cuerpo y marco fabricados en policarbonato
Body and frame made in polycarbonate



05-9373-J6-M3 ■

-  E-27 max. 60W
-  PL elect. E-27 max. 30W

IP 54   6 

 **18W Included**

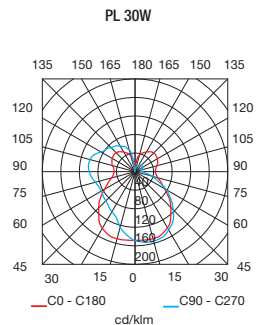

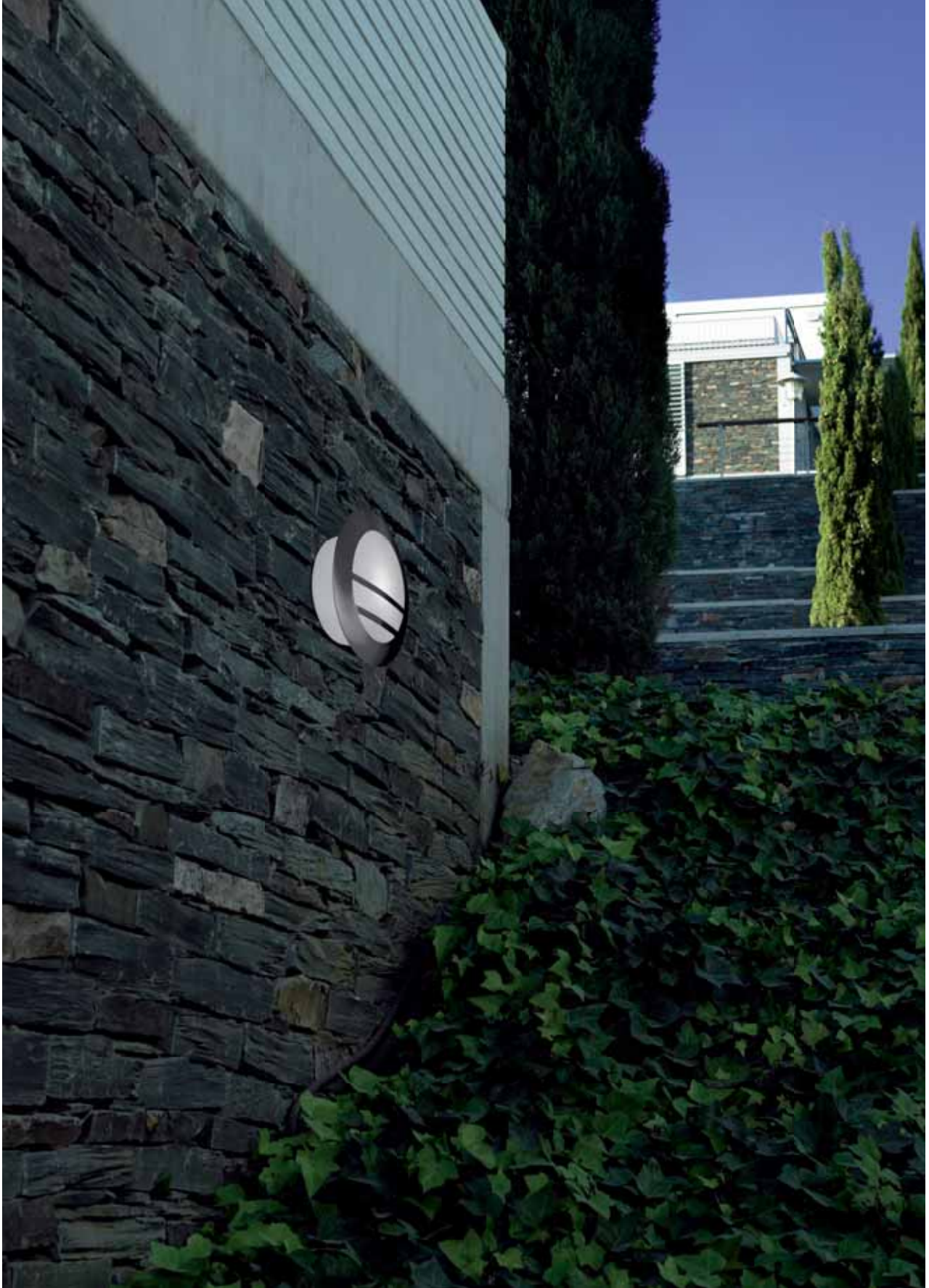

Materiales / Materials



Especificaciones / Specifications



Acabados / Finishes

■ J6 Marrón Brown Marron Braun Marrone Castanho	■ Y4 Acero inoxidable Stainless steel Acier inoxydable Rostfreier Stahl Acciaio inossidabile Aço inoxidável
--	--

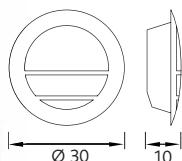

● **05-9288-J6-M1** ■
05-9288-Y4-M1 ■

● E-27 max. 60W
 ● PL elect. E-27 max. 23W

IP 54

▶▶ 18W **Included**

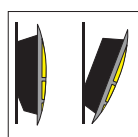

2 posiciones de instalación.
 2 installation positions.
 2 positions d'installation.
 2 Stellungen zur Installation (Einbaustellungen).
 2 posizione d'installazione
 2 posições de instalação.

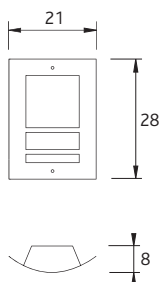
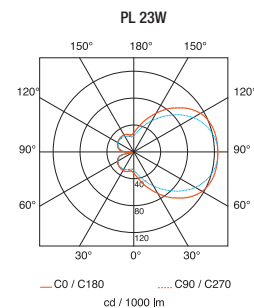

● **05-9207-J6-M1** ■
05-9207-Y4-M1 ■

● E-27 max. 60W
 ● PL elect. E-27 max. 23W

IP 44

▶▶ 18W **Included**

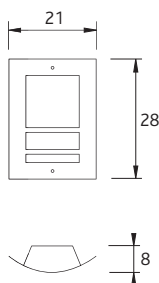
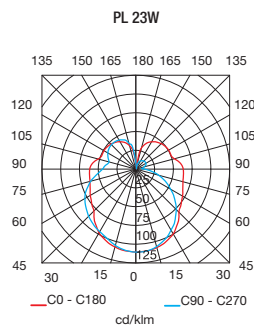

● **05-9236-J6-M1** ■
05-9236-Y4-M1 ■

● E-27 max. 60W
 ● PL elect. E-27 max. 23W

IP 44

▶▶ 18W **Included**



Con sensor de movimiento
 With movement sensor
 Avec détecteur de mouvement
 Bewegungssensor
 Con sensore di movimento
 Com sensor de movimento

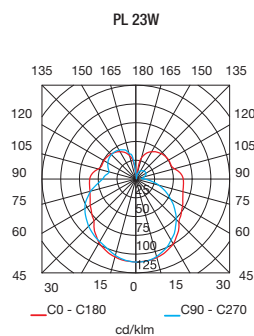

MUY IMPORTANTE consulte la tabla de usos y mantenimiento en la página 274
 VERY IMPORTANT please consult the table on use and maintenance on page 274
 TRÈS IMPORTANT consultez la table d'utilisation et de maintenance de la page 274

WICHTIG Bitte beachten Sie die Tabelle der Gebrauchs- und Instandhaltungsanweisungen auf Seite 274
 MOLTO IMPORTANTE si consulti la tabella di uso e manutenzione a pagina 274
 MUITO IMPORTANTE consulte a tabela de uso e manutenção na página 274

ECLIPSE

Eclipse COLLECTION [®]

- Colección realizada en aluminio y tecnopolímero pensada para su uso como aplique y plafón. Los modelos, aptos para el uso de lámparas de bajo consumo, están disponibles en dos acabados diferentes.
- A collection made of aluminium and technopolymer, designed to be used as a wall fixture and a ceiling fixture. The models are suitable for the use of energy-saving lamps and they are available in two different finishes.
- Une collection en aluminium et technopolymère conçue pour une utilisation applique et plafond. Les modèles permettent l'utilisation de lampes basse consommation et se présentent avec deux finitions différentes.
- Es handelt sich um eine Kollektion, hergestellt aus Aluminium und Technopolymer. Sie ist für die Benutzung als Wand- und Deckenleuchte gedacht. Die Modelle eignen sich für den Gebrauch von Energiesparlampen und sind in zwei verschiedenen Ausführungen erhältlich.
- Collezione realizzata in alluminio e tecnopolimero pensata per l'uso come applique e plafoniera. I modelli, adatti all'uso di lampade a basso consumo, sono disponibili in due rifiniture differenti.
- Coleção feita em alumínio e tecnopolímero pensada para ser usada como applique e lustre. Os modelos, preparados para o uso de lâmpadas de baixo consumo, estão disponíveis com dois acabamentos diferentes.

[®] Registration number: 000835277-0032 / 000835277-0031



Materiales / Materials



Especificaciones / Specifications



Acabados / Finishes

■ 34 Gris Grey Gris Grau Grigio Cinzento	■ Z5 Gris urbano Urban grey Gris urbain Stadtgrau Grigio urbano Cinzeno urbano
---	---

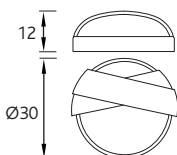

05-9300-34-M3 ■ (S)

05-9300-Z5-M3 ■ (S)

2 x E-27 max. 40W

2 x PL elect. E-27 max. 23W

IP 54

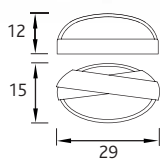
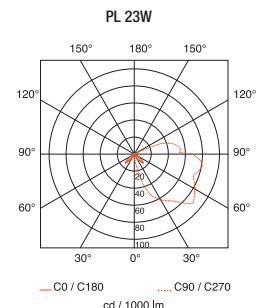

05-9301-34-M3 ■ (S)

05-9301-Z5-M3 ■ (S)

E-27 max. 60W

PL elect. E-27 max. 23W

IP 54

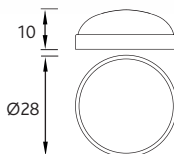
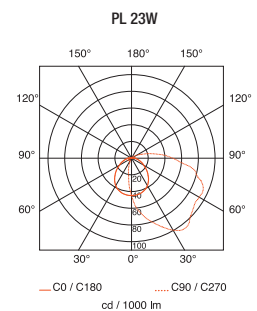

15-9300-34-M3 ■



15-9300-Z5-M3 ■ (S)

2 x G24d-3 26W fluorescent

IP 54



Included

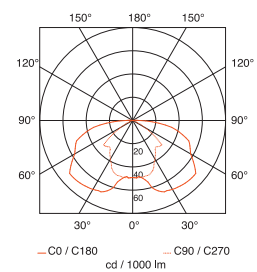

ZEUS

Materiales / Materials



Especificaciones / Specifications

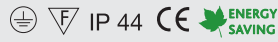

Acabados / Finishes

■ 34 Gris Grey Gris Grau Grigio Cinzeno	■ 05 Negro Black Noir Schwarz Nero Preto	□ 14 Blanco White Blanc Weiß Bianco Branco
--	---	---

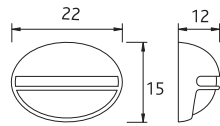

05-8751-34-M3 ■
 05-8751-05-M3 ■
 05-8751-14-M3 □

⦿ E-27 ø 45 max.60W

IP 44 18

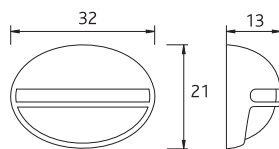

05-8729-34-M3 ■
 05-8729-05-M3 ■
 05-8729-14-M3 □

⦿ E-27 max. 100W

PL elect. E-27 20W - GE

IP 44 6

ATENA



Materiales / Materials

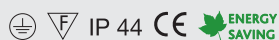

Especificaciones / Specifications



Acabados / Finishes

 34 Gris	 Z5 Gris urbano
Grey	Urban grey
Gris	Gris urbain
Grau	Stadtgrau
Grigio	Grigio urbano
Cinzeno	Cinzeno urbano



05-9131-34-M3 ■
05-9131-Z5-M3 ■

 E-27 max 75W

 PL elect. E-27 max. 23W

IP 44   6 

 18W **Included**

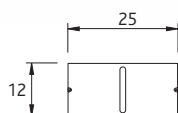

VULCANO

Materiales / Materials



Especificaciones / Specifications

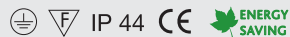

Acabados / Finishes

- 34 Gris
- Grey
- Gris
- Grau
- Grigio
- Cincento

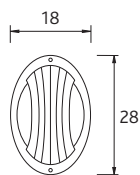

05-8767-34-M3 ■

E-27 ø 45 60W

PL elect. E-27 15W - GE

IP 44   12 

HERCULES

Materiales / Materials



Especificaciones / Specifications



Acabados / Finishes

■ 05 Negro Black Noir Schwarz Nero Preto	□ 14 Blanco White Blanc Weiß Bianco Branco
---	---



05-8783-05-M3 ■
 05-8783-14-M3 □

E-27 max. 60W

PL elect. E-27 max. 23W

IP 44 12

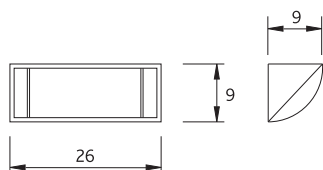



Afrodita COLLECTION [®]

- Colección de apliques de cuidado diseño realizados en aluminio inyectado con dos opciones de difusor: cristal satinado o cristal transparente templado. La serie está formada por nueve apliques y un plafón, en dos acabados diferentes, que pueden colocarse tanto en la pared como en el techo y además, existen variantes Uplight & Downlight. Todos los modelos se presentan con accesorio reflector y con la dirección de la luz orientable.
- Collection of wall fixtures with a careful design made of die-cast aluminum with two diffuser options: glazed glass or clear tempered glass. The series is made up of nine wall fixture and a ceiling fixture with two different finishes. They may be both wall and ceiling mounted. In addition, there are Uplight & Downlight variants. All models come with a reflector accessory with adjustable light direction.
- Collection d'appliques de design soigné réalisées en aluminium injecté, avec deux options de diffuseur : verre satiné ou verre transparent trempé. La série est composée de neuf modèles d'appliques et un plafonnier, dans deux finitions différentes et en versions Uplight & Downlight. Tous les modèles comprennent un accessoire réflecteur et direction de lumière orientable.
- Eine Kollektion von Wandleuchten mit gepflegtem Design aus Aluminiuminjektion und zwei möglichen Ausfertigungsarten des Lichtverteilers: aus satiniertem Glas oder aus durchsichtigem gehärteten Glas. Die Serie besteht aus neun Modellen in zwei Ausfertigungsarten und eins Wandleuchten eingesetzt werden können. Darüber hinaus werden die Varianten Uplight & Downlight angeboten. Alle Modelle schließen eine Reflektorvorrichtung ein und die Lichtstrahlrichtung ist regulierbar.
- Collezione di faretti dal design accurato, realizzati in alluminio iniettato, con possibilità di due tipi di diffusori: in cristallo satinato o in cristallo trasparente temprato. La serie è composta da nove modelli di faretti e uno plafonier, con due diverse finiture, collocabili sia a parete, sia a soffitto, e anche nelle varianti Uplight & Downlight. Tutti i modelli sono provvisti di accessorio riflettore, con possibilità di orientamento della luce.
- Coleção de apliques de concepção cuidada feitos em alumínio injectado com duas opções de difusor: vidro acetinado ou vidro transparente temperado. A série é composta por nove modelos de apliques e uma luminária de tecto, com dois acabamentos diferentes, que podem ser colocados tanto na parede como no tecto e, além disso, há variantes Uplight & Downlight. Todos os modelos se apresentam com acessório reflector e com a direcção da luz orientável.

[®] Registration number: 000835277-0033 / 000966874-24





Materiales / Materials



Especificaciones / Specifications



Acabados / Finishes

■ 34 Gris Grey Gris Grau Grigio Cinzeno	■ Z5 Gris urbano Urban grey Gris urbain Stadtgrau Grigio urbano Cinzeno urbano
--	---

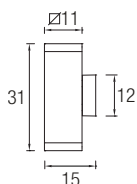

05-9368-34-37 ■
05-9368-Z5-37 ■

2 x Par-30 E-27 max. 75W

2 x Par-30 E-27 15W Fluo

IP 65 6 IK 08

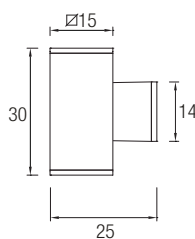
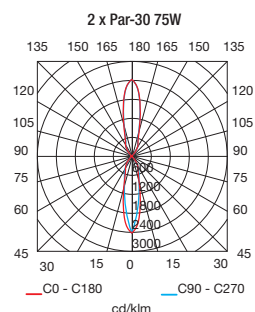

05-9369-34-37 ■
05-9369-Z5-37 ■

G12 70W Halogenurs

IP 65 2 261 IK 8

BAG + Reflector simple y doble
Double and simple reflector **Included**

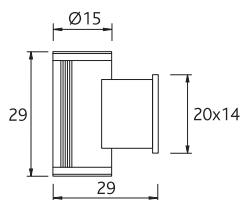
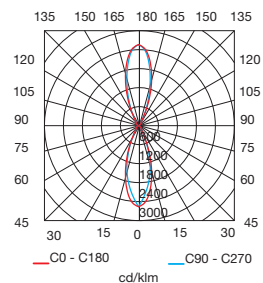

05-9204-34-B8 ■
05-9204-Z5-B8 ■

G12 70W Halogenurs

IP 65 2 IK 08

BAG **Included**

Reflector simple y doble
Double and simple reflector **Included**

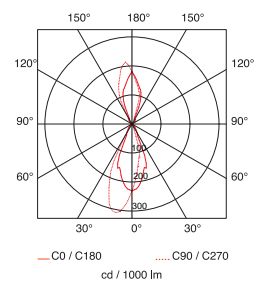



Materiales / Materials



Incluido / Included



Accesorio reflector
Reflector accessory

Especificaciones / Specifications

IP 65 CE RF 850° ENERGY SAVING IK 04

Acabados / Finishes

34 Gris Grey Gris Grau Grigio Cinzentu	J6 Marrón Bown Marron Braun Marrone Castanho	Z5 Gris urbano Urban grey Gris urbain Stadtgrau Grigio urbano Cinzentu urbano
---	---	--

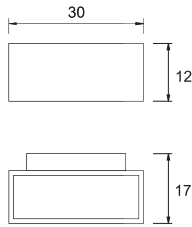

05-9227-34-37 ■
05-9227-Z5-37 ■

Rx7s. 150W Halogenurs

IP 65 2 IK 04

BAG Included

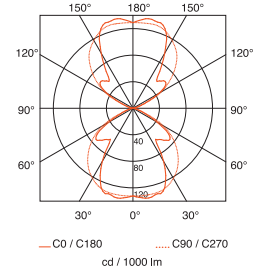

(new)

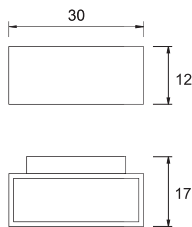

05-9438-34-37 ■
05-9438-Z5-37 ■

Rx7s. 70W Halogenurs

IP 65 2 IK 04

BAG Included

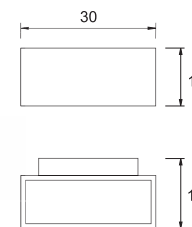
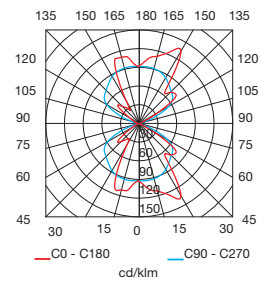

05-9228-34-37 ■
05-9228-Z5-37 ■

2 x G24q-3 26W Fluo

IP 65 2 IK 04

BAG 26W Included

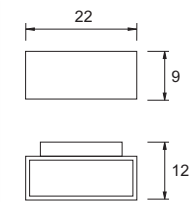
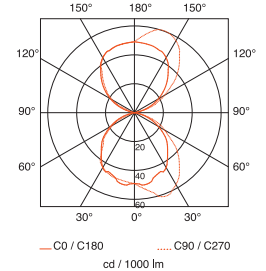

05-9229-34-37 ■
05-9229-J6-37 ■ (new)
05-9229-Z5-37 ■

R7s L=78 max. 150W Halogen

IP 65 4 IK 04

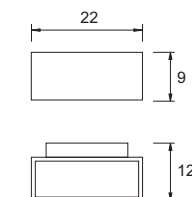
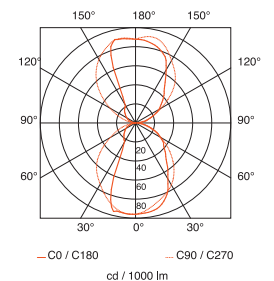

05-9230-34-37 ■
05-9230-J6-37 ■ (new)
05-9230-Z5-37 ■

1 x G24d-3 26W Fluo

IP 65 4 IK 04

BAG / VOSSLOH 26W Included

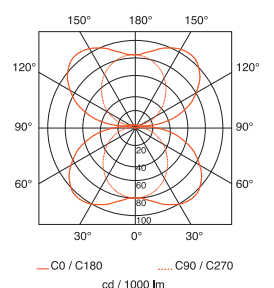



Materiales / Materials



Especificaciones / Specifications



Acabados / Finishes

■ 34 Gris Grey Gris Grau Grigio Cinzento	■ Z5 Gris urbano Urban grey Gris urbain Stadtgrau Grigio urbano Cinzento urbano
---	--

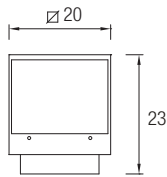

05-9393-34-37 ■
05-9393-Z5-37 ■

G12 70W Halogenurs

IP 65 2 261 IK 08 0.5m

BAG + Cristales lupa Magnifying glasses **Included**

ALU PUR CRIS TRAN

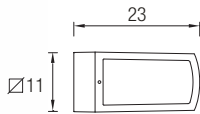
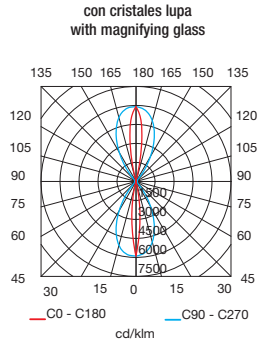

05-9287-34-37 ■
05-9287-Z5-37 ■

E-27 max. 100W

PL elect. E-27 max. 23W

IP 65 6 IK 05

18W + Accesorio reflector Reflector accessory **Included**

ALU INY CRIS STN

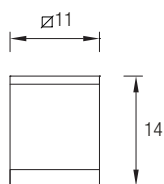
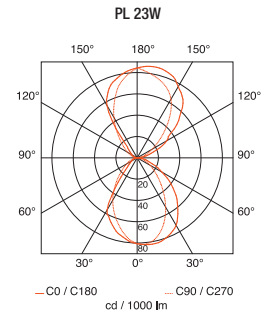

15-9328-34-B8 ■
15-9328-Z5-B8 ■

Par-30 E-27 max. 75W

Par-30 E-27 max. 15W Fluo

IP 54 8 IK 05 0.5m

ALU INY CRIS TRAN

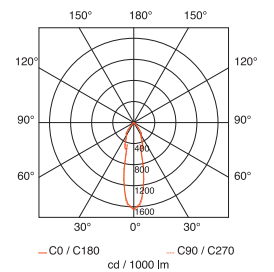

NEMESIS

Nemesis COLLECTION

- Serie de apliques de estilo moderno, con opción de orientar la luz arriba y abajo.
- A collection of modern wall fixtures, with up and down light movement.
- Une série d'appliques de style moderne, avec faisceau lumineux de haut en bas.
- Ein Produktserie von Wandleuchten im modernem Stil, licht geht nach oben und nach unten.
- Serie di applique di stile moderno, con luce sopra e sotto.
- Série de apliques de estilo moderno, com feixe de luz para cima e para baixo.



Características / Specifications



Especificaciones / Specifications



Acabados / Finishes

■ 34 Gris Grey Gris Grau Grigio Cinzento	■ J6 Marrón Brown Marron Braun Marrone Castanho	■ Z5 Gris urbano Urban grey Gris urbain Stadtgrau Grigio urbano Cinzento urbano
---	--	--

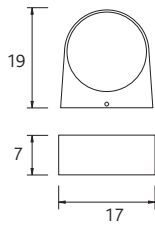

05-9123-34-B8 ■
05-9123-Z5-B8 ■

⊕ E-27 \varnothing 45 max. 60W
 Ⓜ PL elect. E-27 15W - GE

IP 44 ⚡ 12 🌿

PL 15W

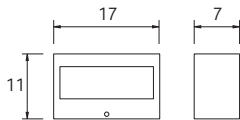
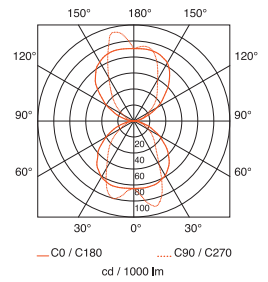

05-9177-34-B8 ■
05-9177-J6-B8 ■ (new)
05-9177-Z5-B8 ■

⊕ R7s L=78 max. 100W

IP 44 ⚡ 12

⊕ R7s L=78 100W OSRAM **Included**

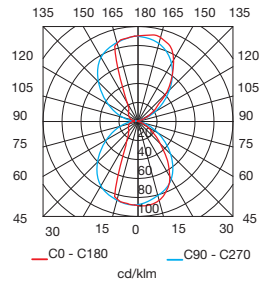

set completo para uso con / complete set to use with PL G24d-1

05-9177 + 71-8969-00-00



71-8969-00-00

Reactancia para PL G24d-1 13W
 Electronic ballast for PL G24d-1 13W

Fenix COLLECTION

- Serie realizada en aluminio inyectado y difusor de cristal transparente. Tres modelos de apliques con dos acabados diferentes y con la posibilidad de direccionar la luz. Hay una versión para halogenuros metálicos con equipo integrado.
- A series made of die-cast aluminium, with a transparent glass diffuser. Three wall fixture models with two different finishes, with the possibility of directing light. There is a version of metal halide lamps with equipment included.
- Série fabriquée en aluminium injecté avec un diffuseur en verre transparent. Trois modèles d'appliques disponibles dans deux finitions différentes et avec la possibilité d'orienter la lumière. Il existe une version avec des lampes halogène métallique avec équipement compris.
- Diese Serie ist aus Aluminiuminjektion hergestellt und mit einem Lichtverteiler aus durchsichtigem Glas versehen. Zur Verfügung stehen drei Wandleuchtenmodelle in zwei Ausführungsarten, deren Lichtstrahlrichtung reguliert werden kann. Es ist eine Ausfertigung von Halogendampflampen aus Metall mit integrierter Vorrichtung vorhanden.
- Serie realizzata in alluminio iniettato con diffusore in cristallo trasparente. Tre modelli di applique con due diverse finiture e possibilità di orientare la luce. Vi è una versione con lampade ad alogenuri metallici e impianto incluso.
- Série feita em alumínio injectado e difusor de vidro transparente. Três modelos de apliques com dois acabamentos diferentes e com a possibilidade de direccionar a luz. Pensados para a utilização de halogenetos metálicos. Uma colecção que se apresenta com equipamentos incluídos.

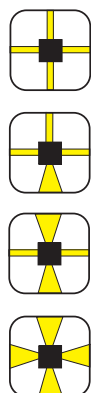

Materiales / Materials



Especificaciones / Specifications

⊕ IP 54 IK 06

Acabados / Finishes

- | | |
|---------|----------------|
| 34 Gris | Z5 Gris urbano |
| Grey | Urban grey |
| Gris | Gris urbain |
| Grau | Stadtgrau |
| Grigio | Grigio urbano |
| Cinzeno | Cinzeno urbano |

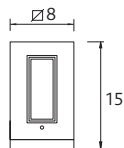

05-9129-34-37
05-9129-Z5-37

G9 max. 60W

IP 54 6 IK 06

40W OSRAM + Cristales lupa y planos **Included**
 Magnifying and flat glasses

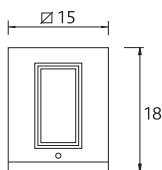
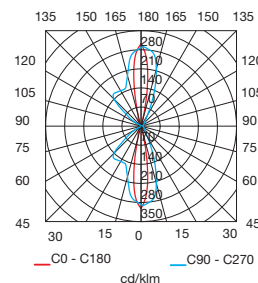

05-9159-34-37
05-9159-Z5-37

R7s L=78 max. 150W

IP 54 2 260 IK 6

150W OSRAM + Cristales lupa y planos **Included**
 Magnifying and flat glasses

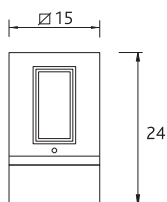
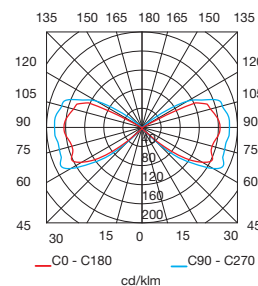

05-9208-34-37 (S)
05-9208-Z5-37 (S)

G12 70W Halogenurs

IP 54 2 IK 06

BAG + Cristales lupa y planos **Included**
 Magnifying and flat glasses

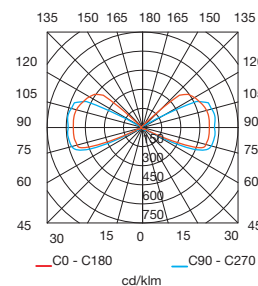



Cosmos COLLECTION

- Colección realizada en aluminio inyectado y difusor de cristal transparente templado. Serie pensada para el uso de lámparas halógenos metálicos, fluorescencia y PAR 30.
- A collection made of die-cast aluminium and a tempered glass diffuser. A series designed to be used with: metal halide lamps, fluorescent lamps, and PAR 30 lamps.
- Collection réalisée en aluminium injecté avec diffuseur en verre transparent trempé. La série permet l'utilisation de lampes halogénures métalliques, fluorescentes et PAR 30.
- Diese Kollektion ist aus Aluminiuminjektion hergestellt und mit einem Lichtverteiler aus durchsichtigem gehärteten Glas versehen. Die Modelle der Serie sind für den Gebrauch von Halogendampflampen aus Metall, Leuchtröhren und PAR 30 vorgesehen.
- Collezione realizzata in alluminio iniettato con diffusore di cristallo trasparente temprato. Serie pensata utilizzo di lampade ad alogenuri metallici, fluorescenti e PAR 30.
- Coleção feita em alumínio injectado e difusor de vidro transparente temperado. Série pensada la utilização de lâmpadas halogenetos metálicos, fluorescência e PAR 30.





Materiales / Materials



Especificaciones / Specifications



Acabados / Finishes

■ 34 Gris Grey Gris Grau Grigio Cinzeno	■ Z5 Gris urbano Urban grey Gris urbain Stadtgrau Grigio urbano Cinzeno urbano
--	---

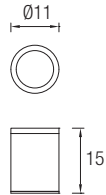

■ 15-9362-34-37 ■
■ 15-9362-Z5-37 ■

Par-30 E-27 max. 75W

Par-30 E-27 15W Fluo

IP 65 6 ENERGY SAVING IK 08

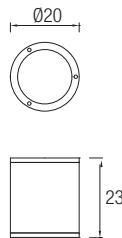
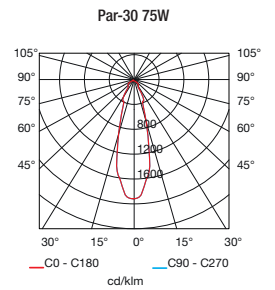

■ 15-9363-34-37 ■
■ 15-9363-Z5-37 ■

Par-38 E-27 80W

PL elect. E-27 max. 30W

Par-38 E-27 23W Fluo

IP 65 4 ENERGY SAVING 262 IK 08

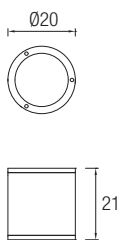
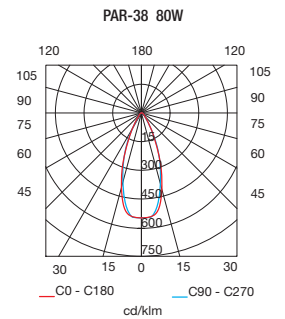

■ 15-9364-34-37 ■
■ 15-9364-Z5-37 ■

G12 70W Halogenurs

IP 65 2 ENERGY SAVING 262 IK 08

BAG Included

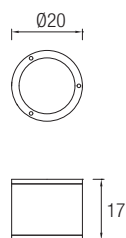
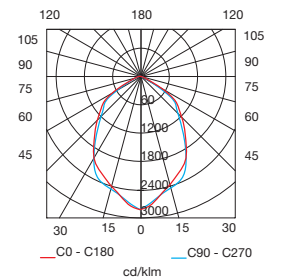

■ 15-9365-34-T2 ■
■ 15-9365-Z5-T2 ■

2 x GX24d-3 26W

IP 65 2 ENERGY SAVING 262 IK 08

BAG Included

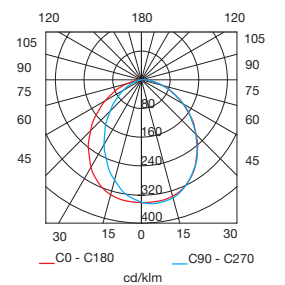



Hubble COLLECTION [®]

- Projector realizado en aluminio de alta calidad y con difusor de cristal templado, disponible en dos acabados diferentes de gris. Apto para uso de lámparas GU-10 de bajo consumo o LED.
- Projector made of high quality aluminium with a tempered glass diffuser, available in two different grey finishes. Suitable for use with GU-10 low energy lights or LEDs.
- Projecteur réalisé en aluminium de haute qualité avec un diffuseur en verre trempé, disponible dans deux finitions différentes de gris. Il peut être utilisé avec des ampoules GU-10 à économie d'énergie ou des LED.
- Scheinwerfer aus hochwertigem Aluminium mit Diffusor aus gehärtetem Glas. Erhältlich in zwei verschiedenen Ausfertigungen in Grau. Geeignet für die Verwendung von GU-10 Energiesparlampen oder LED.
- Proiettore realizzato in alluminio di alta qualità e con diffusore in cristallo temprato, disponibile in due finiture grigie differenti. Adatto per l'uso di lampadine GU-10 a basso consumo o a LED.
- Projector concebido em alumínio de alta qualidade e com difusor em vidro temperado, disponível com dois acabamentos diferentes em cinzento. Preparado para o uso de lâmpadas GU-10 de baixo consumo ou LED.

[®] Registration number: Pending





Materiales / Materials



Incluido / Included



Especificaciones / Specifications

IP 65 CE ENERGY SAVING IK 09



Acabados / Finishes

■ 34 Gris	■ Z5 Gris urbano
Grey	Urban grey
Gris	Gris urbain
Grau	Stadtgrau
Grigio	Grigio urbano
Cinzeno	Cinzeno urbano

(new)

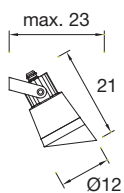

05-9416-34-37 ■



05-9416-Z5-37 ■

GU-10 max. 50W

GU-10 max. 11W Fluorescent

GU-10 max. 5W LED

IP 65 6 ENERGY SAVING IK 09

Visera incluida
Visor included



O'COLOR COLLECTION ®

- Novedosa colección fabricada en aluminio inyectado. Los modelos diseñados según la tendencia más contemporánea incluyen embellecedores de 3 colores distintos y cuentan con protección IP 54. Además, pueden utilizar lámparas halógenas o halogenuros metálicos.
- Innovative collection made of die-cast aluminum. The models designed according to the latest trend include trim with three different colors, and they have IP 54 protection. Additionally, they may use halogen lamps or metal halide lamps.
- Nouvelle collection réalisée en aluminium injecté. Dessinée suivant la tendance la plus actuelle, ces modèles comprennent des enjoliveurs de 3 couleurs différentes et disposent de protection IP 54. De plus, ils peuvent recevoir des lampes halogènes ou des lampes à halogénure métallique.
- Eine neuartige Kollektion, die aus Aluminiuminjektion hergestellt ist. Das Design der Modelle folgt den neuesten modischen Tendenzen. Eingeschlossen sind Verblendungen in 3 verschiedenen Farben und die Modelle verfügen über Schutzvorrichtungen der Klasse IP 54. Sie können mit Halogenlampen und metallischen Halogenidlampen benutzt werden.
- Nuova collezione realizzata in alluminio iniettato. I modelli progettati secondo il trend più attuale includono delle ghiera in 3 colori distinti e prevedono una protezione classe IP 54. Possono inoltre utilizzare lampade alogene o ad alogenuri metallici.
- Coleção inovadora fabricada em alumínio inyectado. Os modelos concebidos de acordo com a tendência mais contemporânea incluem embelezadores de 3 cores diferentes e têm protecção IP 54. Além disso, podem utilizar lâmpadas de halogéneo ou halogenetos metálicos.

® Registration number: 001091375-030





Materiales / Materials



3 aros de colores incluidos
 3 color rings included
 3 anneaux de couleur compris
 3 austauschbare Farbringe inklusive
 3 anelli di colore inclusi
 3 aros de cores incluidos

Especificaciones / Specifications

IP 65 CE RF 850° ENERGY SAVING IK 09

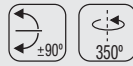

Incluido / Included



Acabados / Finishes

34 Gris
 Grey
 Gris
 Grau
 Grigio
 Cinzento

(NEW)

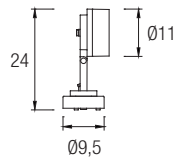

05-9417-34-T2 ■

GX 53 max. 13W - 230V

IP 65 6 IK 09

7W **Included**

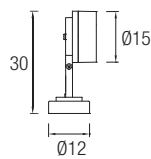
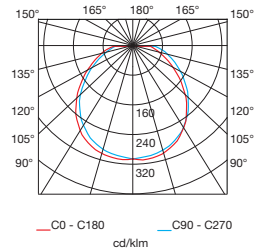

05-9359-34-T2 ■

R7s L=78 max. 150W

IP 65 4 IK 09

150W OSRAM **Included**

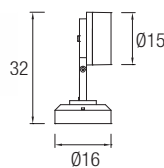
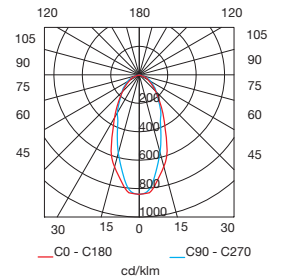

05-9360-34-T2 ■

G 8.5 35W Halogenurs

IP 65 2 IK 09

VOSSLOH / PHILIPS **Included**

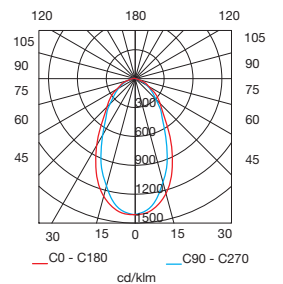

ALIEN



Alien COLLECTION [®]

- Los focos Alien se adaptan a todo tipo de ambientes de exterior y requisitos de iluminación gracias a la gran variedad de lámparas disponibles. Adicionalmente, Alien se puede orientar hacia todas direcciones.
- The Alien lights adapt to all kinds of outdoor environments and lighting requirements, thanks to the large variety of available lamps. Alien can also be turned in all directions.
- Les spots Alien s'adaptent à tous les types d'espaces extérieurs et aux différents besoins d'illumination grâce à la grande variété de lampes disponibles. De plus, Alien diffuse la lumière dans toutes les directions.
- Die Alien Scheinwerfer passen sich an jegliches Außenambiente und erforderliche Beleuchtungsstärken, dank der großen Auswahl an Lampen, an. Außerdem kann man die Alien Scheinwerfer in alle Richtungen verstellen.
- I riflettori Alien si adattano a ogni tipo di ambiente in esterni e a qualsiasi requisito di illuminazione grazie alla grande varietà di lampade disponibili. Inoltre, Alien si può orientare in tutte le direzioni.
- Os focos Alien adaptam-se a todo o tipo de ambientes de exterior e requisitos de iluminação graças à grande variedade de lâmpadas disponíveis. Adicionalmente o Alien pode ser orientado em todas direcções.

[®] Registration number: 000835277-0030

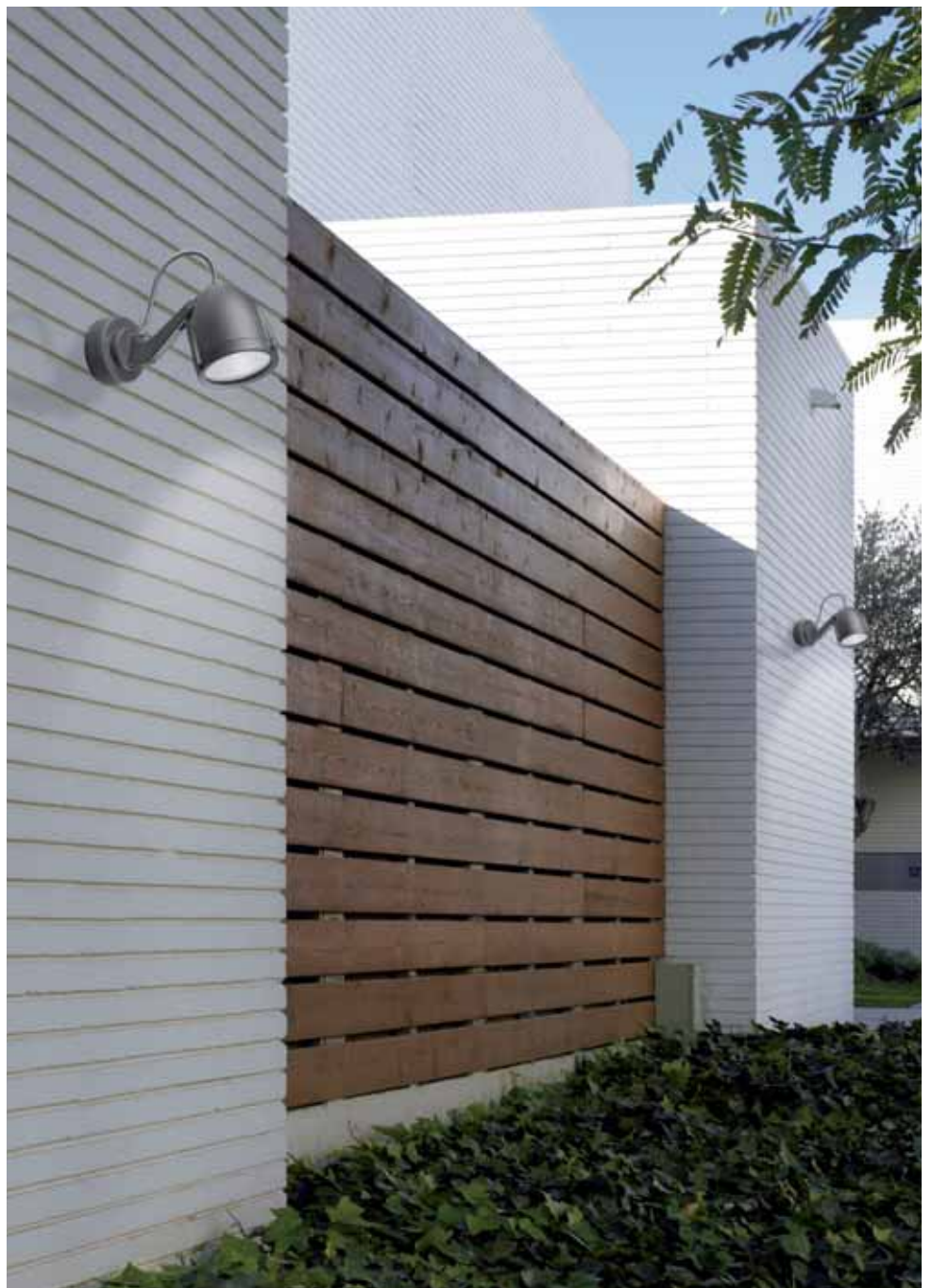

Materiales / Materials



Incluido / Included



Especificaciones / Specifications



Acabados / Finishes

- 34 Gris
Grey
Gris
Grau
Grigio
Cinzeno
- Z5 Gris urbano
Urban grey
Gris urbain
Stadtgrau
Grigio urbano
Cinzeno urbano

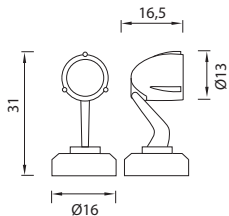

05-9297-34-37 ■

05-9297-Z5-37 ■

GX 8.5 70W Halogenurs

IP 65 4 IK 05

Included

CDM-R111 70W 40D

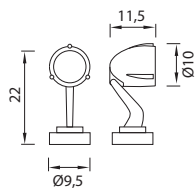
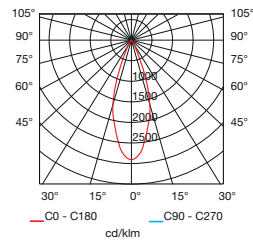

05-9327-34-37 ■

05-9327-Z5-37 ■

GU-10 max. 50W

GU-10 max. 11W Fluorescent

GU-10 max. 5W LED

IP 65 8 IK 05

GU-10 50W

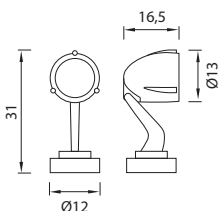
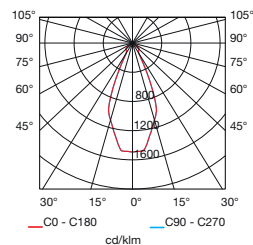

05-9296-34-37 ■

05-9296-Z5-37 ■

E-27 100W-HAL

Par-30 E-27 max. 75W





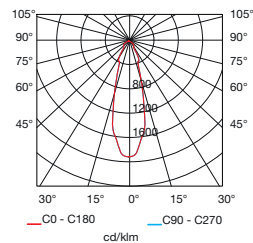

Par-30 E-27 max. 15W Fluo

IP 65 4 IK 05

Par-30 75W





SKADE

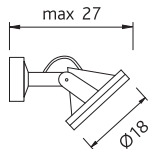

Materiales / Materials	Especificaciones / Specifications	Acabados / Finishes		
 	  	<table border="0"> <tr> <td data-bbox="942 312 1063 455"> 34 Gris Grey Gris Grau Grigio Cinzenito </td> <td data-bbox="1103 312 1276 455"> Z5 Gris urbano Urban grey Gris urbain Stadtgrau Grigio urbano Cinzenito urbano </td> </tr> </table>	34 Gris Grey Gris Grau Grigio Cinzenito	Z5 Gris urbano Urban grey Gris urbain Stadtgrau Grigio urbano Cinzenito urbano
34 Gris Grey Gris Grau Grigio Cinzenito	Z5 Gris urbano Urban grey Gris urbain Stadtgrau Grigio urbano Cinzenito urbano			
Incluido / Included	 			
				



05-9107-34-37 

05-9107-Z5-37 







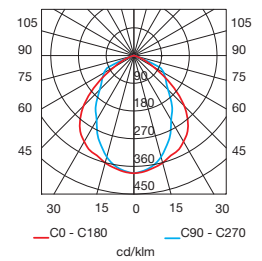

 R7s L=78 max. 150W

IP 65   2

 R7s L=78 150W OSRAM **Included**



EOLO

Materiales / Materials	Especificaciones / Specifications	Acabados / Finishes
 	    	Y4 Acero inoxidable Stainless steel Acier inoxydable Rostfreier Stahl Acciaio inossidabile Aço inoxidável
		

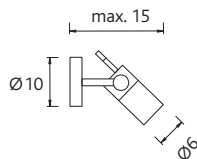



05-9122-Y4-37 

 GU-10 max. 50W

 GU-10 max. 11W Fluorescent

 GU-10 max. 5W LED

IP 55   12 

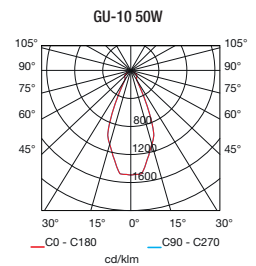

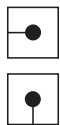

Materiales / Materials



Especificaciones / Specifications



Acabados / Finishes

- 05 Negro
Black
Noir
Schwarz
Nero
Preto
- 34 Gris
Grey
Gris
Grau
Grigio
Cinzeno
- Y4 Acero inoxidable
Stainless steel
Acier inoxydable
Rostfreier Stahl
Acciaio inossidabile
Aço inoxidável

Incluido / Included

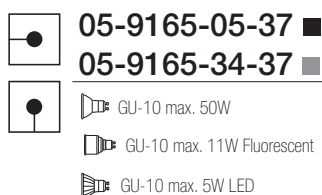
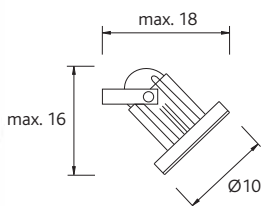

- ▶ GU-10 max. 50W
- ▶ GU-10 max. 11W Fluorescent
- ▶ GU-10 max. 5W LED

IP 65 8,5h 12

OSRAM 50W **Included**

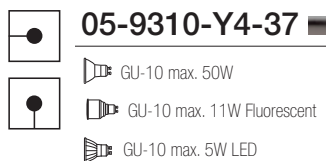
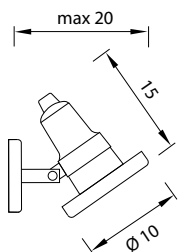
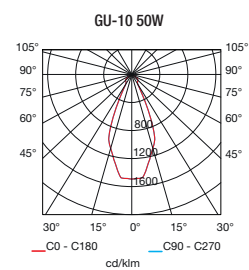

- ▶ GU-10 max. 50W
- ▶ GU-10 max. 11W Fluorescent
- ▶ GU-10 max. 5W LED

IP 67 8 IK 08

OSRAM 50W **Included**

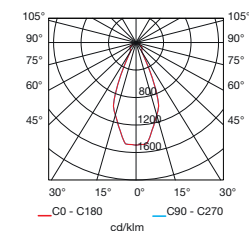

MUY IMPORTANTE consulte la tabla de usos y mantenimiento en la página 274
VERY IMPORTANT please consult the table on use and maintenance on page 274
TRÈS IMPORTANT consultez la table d'utilisation et de maintenance de la page 274

WICHTIG Bitte beachten Sie die Tabelle der Gebrauchs- und Instandhaltungsanweisungen auf Seite 274
MOLTO IMPORTANTE si consulti la tabella di uso e manutenzione a pagina 274
MUITO IMPORTANTE consulte a tabela de uso e manutenção na página 274

ESPARTA



Esparta COLLECTION

- La serie Esparta funciona con fluorescencia, aportando una estanquidad superior, a la vez que es orientable.
- The Esparta collection works with fluorescent lights and offers high leaktightness, and the light can be turned.
- La Série Esparta est une série fluorescente offrant à la fois une étanchéité supérieure et une diffusion orientable.
- Die Esparta Produktserie wird mit Leuchtstofflampen betrieben, sie besitzt eine obere Abdichtung und ist gleichzeitig verstellbar.
- La serie Esparta funziona con lampade a fluorescenza, è dotata di superiore tenuta all'acqua e al tempo stesso è orientabile.
- A série Esparta funciona com fluorescência, proporcionando uma estanquidade superior, sendo também orientável.

 Registration number: 001091375-031



Materiales / Materials



Incluido / Included



Especificaciones / Specifications



Acabados / Finishes

■ 05 Negro Black Noir Schwarz Nero Preto	■ 34 Gris Grey Gris Grau Grigio Cinzentu	■ Z5 Gris urbano Urban grey Gris urbain Stadtgrau Grigio urbano Cinzentu urbano
---	---	--

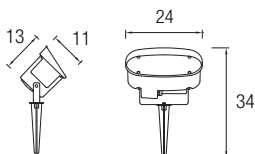

55-9349-Z5-M3 ■

G24d-3 26W Fluo

IP 65 4 IK 09

G24d-3 26W Fluo + BAG Included

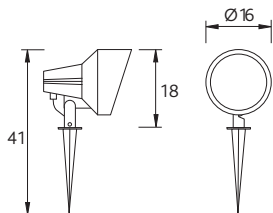
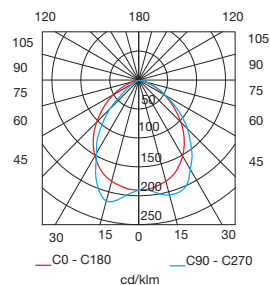

55-9172-34-37 ■

Par-38 E-27 max. 60W

IP 54 12 IK 08

2,5 m Included

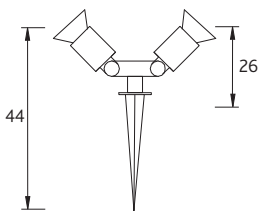
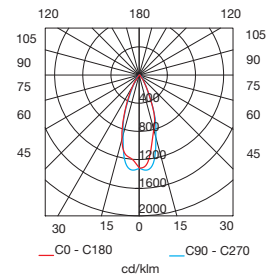

55-8785-05-05 ■

2 x Par-38 E-27 max. 100W

IP 44 0,5m 18

2,5 m Included

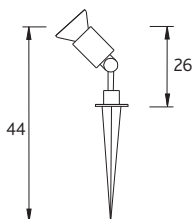

55-8784-05-05 ■

Par-38 E-27 max. 100W

IP 44 0,5m 18

2,5 m Included



TEMIS

Temis 76

Materiales / Materials



Especificaciones / Specifications



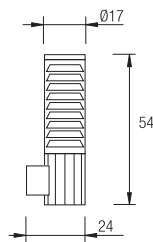

Acabados / Finishes

- 34 Gris
- Grey
- Gris
- Grau
- Grigio
- Cinzeno



05-9268-34-M2 ■

-  E-27 - Halogen max. 150W
-  PL elect. E-27 max. 30W
-  Mezcla E-27 max. 160W

IP 65   2  IK 08



PL 30W

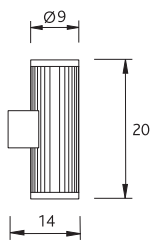
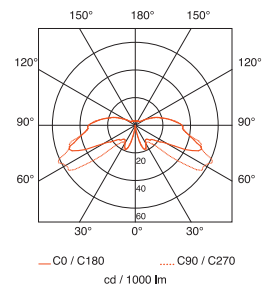

05-9146-34-T2 ■

-  2 x GU-10 max. 50W
-  2 x GU-10 max. 11W Fluorescent
-  2 x GU-10 max. 5W LED

IP 44    4  IK 08



 2 x OSRAM 50W **Included**

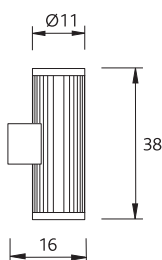
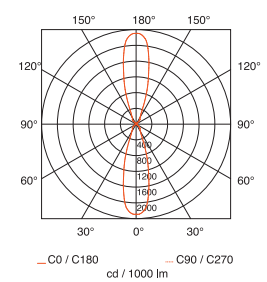

GU-10 50W



05-9173-34-T2 ■

-  2 x Par-30 E-27 max. 75W
-  2 x PL elect. E-27 max. 23W

IP 44    4  IK 08



Par-30 75W

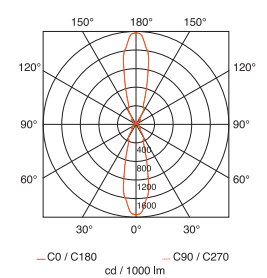

FLASH

Materiales / Materials



Especificaciones / Specifications



Acabados / Finishes

- 34 Gris
- Grey
- Gris
- Grau
- Grigio
- Cinzento

Incluido / Included

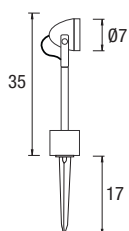

05-9241-34-37 ■



3 POWER LEDS X 1 W 3W-230V

IP 65 2

Included

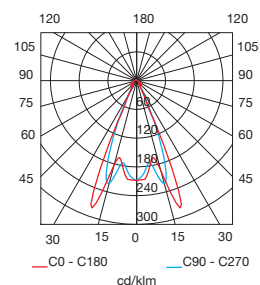



Pompeya COLLECTION [®]

- Serie formada por varios modelos de apliques proyectores de altas prestaciones y dos modelos de balizas realizadas en aluminio inyectado. La colección está preparada para el uso de diferentes lámparas: fluorescentes, halógenas y halogenuros metálicos.
- A collection of various models of high performance projecting wall fixtures, and two models of beacons made of die-cast aluminium. The collection is prepared for the use of different lamps: fluorescent, halogen and metal halide.
- Série composée de plusieurs modèles d'appliques/projecteurs, haute performance, et de deux modèles de balises réalisées en aluminium injecté. La collection est compatible avec différentes lampes: fluorescentes, halogènes et halogénures métalliques.
- Eine Produktserie, die aus mehreren Modellen von Wandprojektoren mit Höchstleistungen besteht und zwei Modellen von Leuchtbaken, gefertigt aus gespritztem Aluminium. Die Kollektion ist für den Gebrauch von verschiedenen Leuchtstoff-, Halogen- und Halogendampflampen aus Metall vorgesehen.
- Serie costituita da vari modelli di applique-proiettori da parete ad alte prestazioni e da due modelli di faretti, realizzati in alluminio iniettato. La collezione è predisposta per l'uso di lampade a fluorescenza, alogene e ad alogenuri metallici.
- Série composta por vários modelos de apliques projector de parede de altas prestações e dois modelos de sinalizações feitos em alumínio injectado. A colecção está preparada para o uso de diferentes lâmpadas: fluorescentes, de halogéneo e halogenetos metálicos.

[®] Registration number: Pending





Materiales / Materials



Especificaciones / Specifications



Acabados / Finishes

- 34 Gris
- Grey
- Gris
- Grau
- Grigio
- Cinzeno

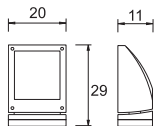

05-9250-34-37 ■ (S)

R7s L=118 max. 300W Halogen

IP 65 4 IK 08

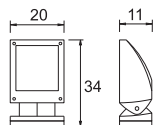
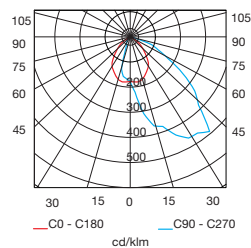

05-9251-34-37 ■ (S)

R7s L=118 max. 300W Halogen

IP 65 4 IK 08

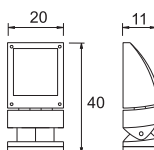
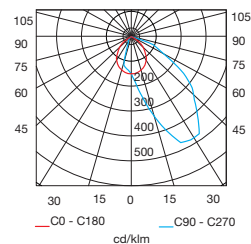

05-9252-34-37 ■

Rx7s 70W Halogenurs

IP 65 2 IK 08

PHILIPS **Included**

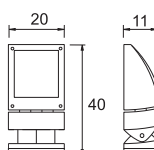
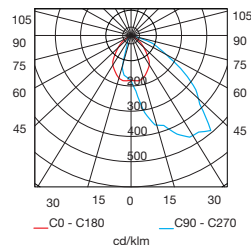

05-9253-34-37 ■

Rx7s 150W Halogenurs

IP 65 2 IK 08

PHILIPS **Included**

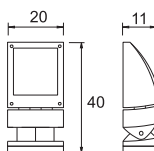
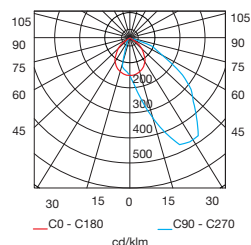

05-9254-34-37 ■

2 x GX24q-3 26W Fluo

IP 65 2 IK 08

BAG **Included**

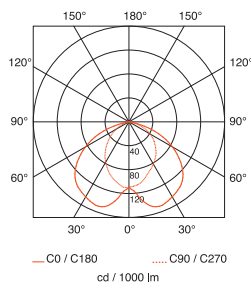

Materiales / Materials



Especificaciones / Specifications



Acabados / Finishes

- 34 Gris
- Grey
- Gris
- Grau
- Grigio
- Cinzentu



71-9291-34-34 ■

Soportes para instalación en poste de Ø 60 mm. Para usar con **05-9251, 05-9252, 05-9253, 05-9254**
 Supports for installing in Ø 60 mm post. For use with **05-9251, 05-9252, 05-9253, 05-9254**



71-9292-34-34 ■

Soportes para instalación en poste de Ø 60 mm. Para usar con **05-9251, 05-9252, 05-9253, 05-9254**
 Supports for installing in Ø 60 mm post. For use with **05-9251, 05-9252, 05-9253, 05-9254**

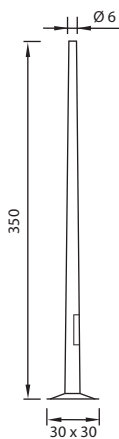

55-9305-48-48

55-9305-48-48 ■

Columna 3,5 m / 3,5 m. column



Kit de instalación incluido.
 Installation kit included.
 Kit d'installation compris.
 Einbaukit inklusive.
 Kit installazione incluso.
 Kit de instalação incluso.

Materiales / Materials



Especificaciones / Specifications

⊕ ⚡ IP 65 CE RF 850° IK 08



Acabados / Finishes

- 34 Gris
- Grey
- Gris
- Grau
- Grigio
- Cinzento

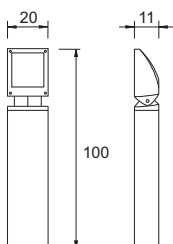

55-9250-34-37 ■ (S)

Rx7s 70W Halogenurs

IP 65 2 263 IK 08 0,5m

BAG Included

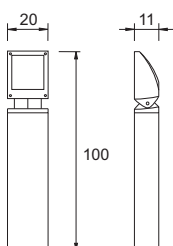
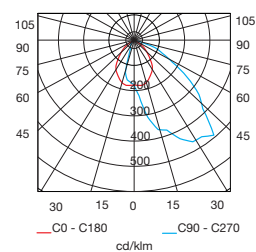

55-9251-34-37 ■ (S)

Rx7s 150W Halogenurs

IP 65 2 263 IK 08 0,5m

BAG Included

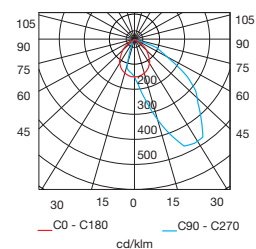

HECATE

Hecate COLLECTION

- Los bañadores de pared Hecate están disponibles en cuatro longitudes diferentes y siempre en fluorescencia. Fabricados en aluminio extrusionado, proporcionan un elevado IP y incluyen una reactancia electrónica.
- The Hecate wash lights are available in four different lengths, and always fluorescent. They are made of extruded aluminium and offer a high IP rating, and include electronic reactance.
- Les projecteurs muraux Hecate sont fluorescents et disponibles en quatre longueurs différentes. Fabriqués en aluminium extrudé, ils offrent un indice élevé de protection IP et disposent d'une réactance électronique.
- Die Wand-Lichtdiffusoren Hecate sind in vier verschiedenen Längen, ausschließlich mit Leuchtstofflampen, erhältlich. Sie sind aus extrudiertem Aluminium hergestellt, bieten einen hohen IP Schutz und schließen eine elektronische Reaktanz ein.
- Gli elementi bagnabili da parete Hecate sono disponibili in quattro lunghezze differenti e sempre in fluorescenza. Fabbricati in alluminio estruso offrono un alto grado di resistenza IP e includono una reattanza elettronica.
- Os lustres de parede Hecate estão disponíveis em quatro comprimentos diferentes e sempre fluorescentes. Fabricados em alumínio extrusionado, proporcionam um elevado IP e incluem uma reactância electrónica.



Materiales / Materials



Accesorios para fijación en pared o techo incluidos.
 Accessories for wall or ceiling fitting included.
 Accessoires de fixation murale ou au plafond inclus.
 Zubehör zur Befestigung an Wänden und Decken inklusive.
 Accessori per fissaggio nella parete o tetto inclusi.
 Acessórios para a fixação em parede ou tecto incluídos.

Especificaciones / Specifications

⊕ ⊖ IP 65 CE ENERGY SAVING IK 07



Acabados / Finishes

Z5 Gris urbano
 Urban grey
 Gris urbain
 Stadtgrau
 Grigio urbano
 Cinzento urbano

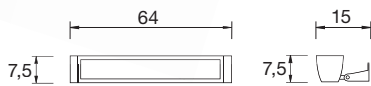

05-9264-Z5-37 ■

T5 24W Fluorescent

IP 65 2 ENERGY SAVING IK 07

BAG Included

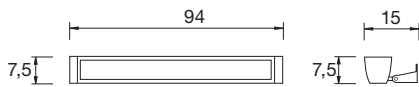
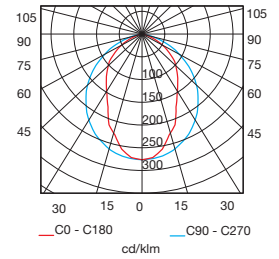

05-9265-Z5-37 ■

T5 39W Fluorescent

IP 65 2 ENERGY SAVING IK 07

BAG Included

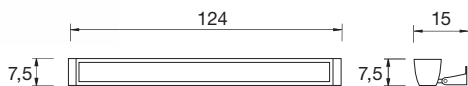
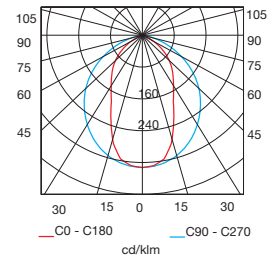

05-9266-Z5-37 ■

T5 54W Fluorescent

IP 65 2 ENERGY SAVING IK 07

BAG Included

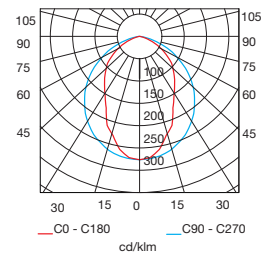

(new)

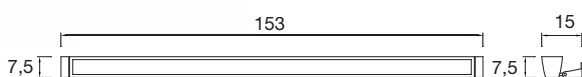

05-9439-Z5-37 ■

T5 80W Fluorescent

IP 65 2 ENERGY SAVING IK 07

BAG Included

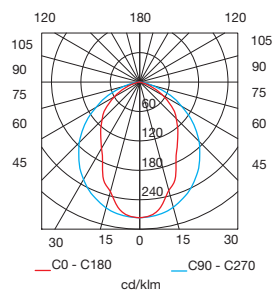



Gea COLLECTION [®]

- Amplia colección de empotrables realizados en aluminio, tecnopolímero y acero inoxidable 304 o 316 para uso profesional con gran variedad de lámparas y LEDs. Los modelos tienen una alta protección IP (hasta IP 68).
- A large collection of built-in luminaires, made of aluminium, technopolymer and stainless steel 304 or 316. It is for professional use, with a wide range of lamps and LEDs. The models have a high IP rating (up to IP68).
- Une vaste collection d'encastrables en aluminium, technopolymère et acier inoxydable 304 ou 316. Une série destinée à usage professionnel avec une grande variété de lampes et LEDs. Les modèles disposent d'un indice élevé de protection IP (jusqu'à 68 IP).
- Umfangreiche Kollektion von Einbauleuchten, hergestellt aus Aluminium, Technopolymer und rostfreiem Stahl 304 oder 316, für den professionellen Gebrauch gedacht. Sie enthält eine große Vielfalt an Leuchten und LEDs. Alle Modelle verfügen über einen hohen IP - Schutz (bis zu 68 IP).
- Amplia collezione di elementi a incasso realizzati in alluminio, tecnopolimero e acciaio inossidabile 304 o 316. Per uso professionale con grande varietà di lampade e LED. I modelli hanno un elevato grado di protezione IP (fino a IP 68).
- Uma vasta coleção de encastráveis feitos em alumínio, tecnopolímero e aço inoxidável 304 ou 316 para uso profissional com uma grande variedade de lâmpadas e LED's. Os modelos têm uma alta protecção IP (até IP 68).

[®] Registration number: 000966874-025





Materiales / Materials



Incluido / Included



Especificaciones / Specifications

IP 67 CE RF 850° ENERGY SAVING IK 08



Acabados / Finishes

Y4 Acero inoxidable
Stainless steel
Acier inoxydable
Rostfreier Stahl
Acciaio inossidabile
Aço inoxidável

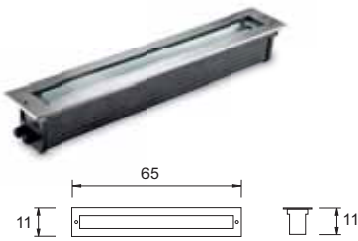

55-9264-Y4-37

T5 24W Fluorescent <40°C

IP 67 2 264 IK 08

BAG Included

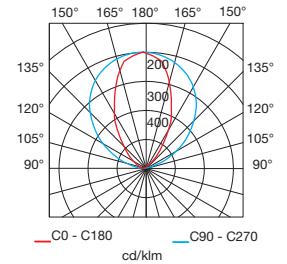

55-9265-Y4-37

T5 39W Fluorescent <40°C

IP 67 2 264 IK 08

BAG Included

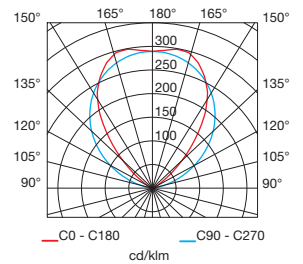

55-9266-Y4-37

T5 54W Fluorescent <40°C

IP 67 2 264 IK 08

BAG Included

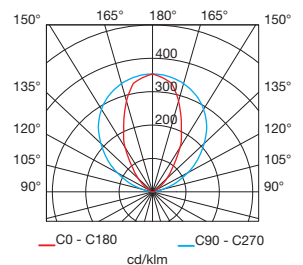

MUY IMPORTANTE consulte la tabla de usos y mantenimiento en la página 274
VERY IMPORTANT please consult the table on use and maintenance on page 274
TRÈS IMPORTANT consultez la table d'utilisation et de maintenance de la page 274

WICHTIG Bitte beachten Sie die Tabelle der Gebrauchs- und Instandhaltungsanweisungen auf Seite 274
MOLTO IMPORTANTE si consulti la tabella di uso e manutenzione a pagina 274
MUITO IMPORTANTE consulte a tabela de uso e manutenção na página 274



Materiales / Materials



Especificaciones / Specifications



Acabados / Finishes

Y4 Acero inoxidable
Stainless steel
Acier inoxydable
Rostfreier Stahl
Acciaio inossidabile
Aço inoxidável

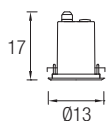

15-9381-Y4-37

- GU-10 max. 50W
- GU-10 max. 11W Fluorescent
- GU-10 max. 5W LED

IP 67 4 262 IK 08

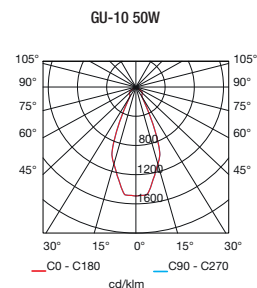

71-9448-Y4-Y4

Aro de acero inoxidable AISI 316 para 15-9381
Stainless steel AISI 316 ring for 15-9381

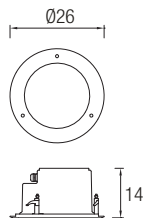

15-9391-Y4-B8

- GX24d-3 26W
- IP 66 2 262 IK 08
- BAG Included

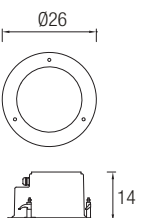
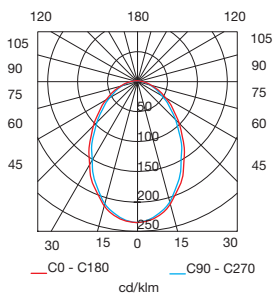

15-9392-Y4-B8

- 2 x GX24d-3 26W
- IP 66 2 262 IK 08
- BAG Included

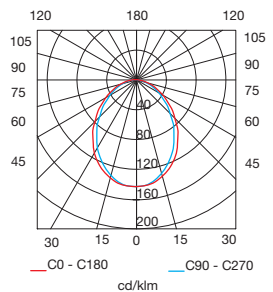

MUY IMPORTANTE consulte la tabla de usos y mantenimiento en la página 274
VERY IMPORTANT please consult the table on use and maintenance on page 274
TRÈS IMPORTANT consultez la table d'utilisation et de maintenance de la page 274

WICHTIG Bitte beachten Sie die Tabelle der Gebrauchs- und Instandhaltungsanweisungen auf Seite 274
MOLTO IMPORTANTE si consulti la tabella di uso e manutenzione a pagina 274
MUITO IMPORTANTE consulte a tabela de uso e manutenção na página 274

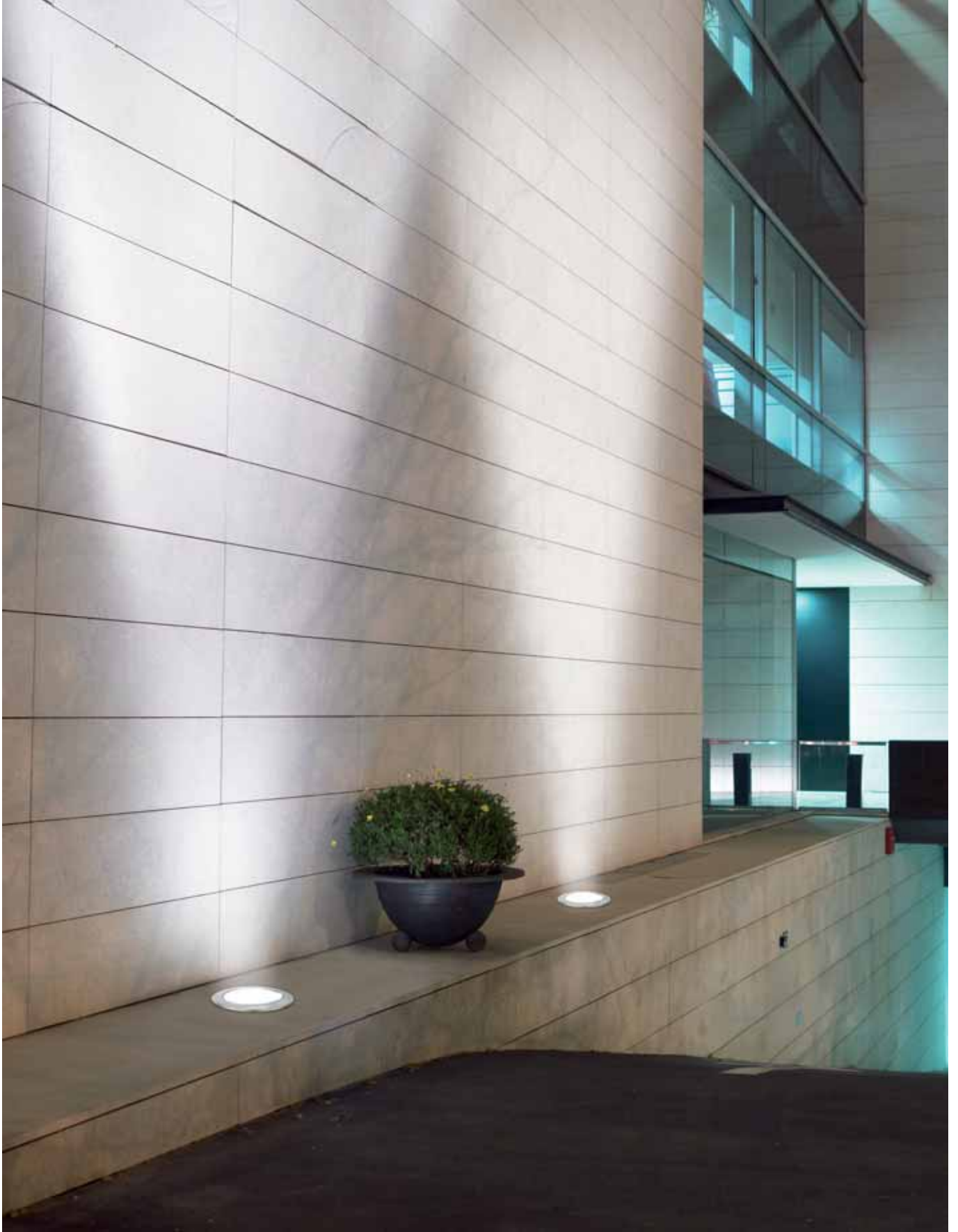

Materiales / Materials



2 reflectores incluidos.
2 reflectors included.
2 réflecteurs inclus.
2 Reflektore inklusive.
2 riflettori inclusi.
2 reflectores incluidos

Especificaciones / Specifications

IP 67 ENERGY SAVING IK 08



Incluido / Included



Acabados / Finishes

Y4 Acero inoxidable
Stainless steel
Acier inoxydable
Rostfreier Stahl
Acciaio inossidabile
Aço inoxidável

(new)

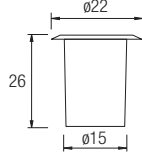

55-9433-Y4-37

Rx7s. 70W Halogenurs >80°C

IP 67 ENERGY SAVING IK 08

BAG Included

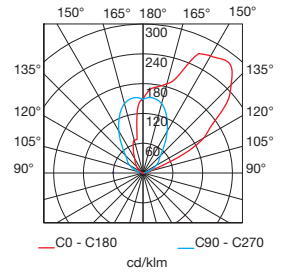

71-9453-Y4-Y4

Aro de acero inoxidable AISI 316 para 55-9433
Stainless steel AISI 316 ring for 55-9433

(new)

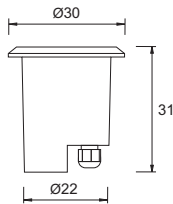

55-9429-Y4-37

G12 150W Halogenurs >80°C

IP 67 ENERGY SAVING IK 08

BAG Included

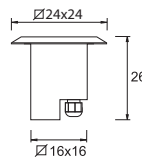
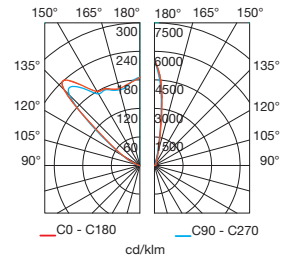

55-9232-Y4-37

G12 70W Halogenurs >80°C

IP 67 ENERGY SAVING IK 08

BAG Included

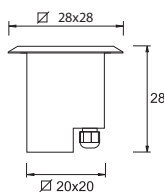
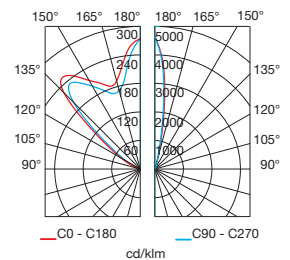

55-9233-Y4-37

G12 150W Halogenurs >80°C

IP 67 ENERGY SAVING IK 08

BAG Included

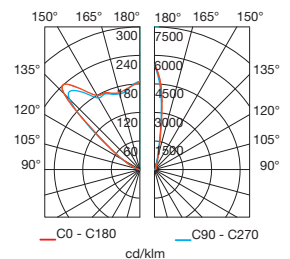

MUY IMPORTANTE consulte la tabla de usos y mantenimiento en la página 274
VERY IMPORTANT please consult the table on use and maintenance on page 274
TRÈS IMPORTANT consultez la table d'utilisation et de maintenance de la page 274

WICHTIG Bitte beachten Sie die Tabelle der Gebrauchs- und Instandhaltungsanweisungen auf Seite 274
MOLTO IMPORTANTE si consulti la tabella di uso e manutenzione a pagina 274
MUITO IMPORTANTE consulte a tabela de uso e manutenção na página 274

Materiales / Materials



2 reflectores incluidos.
2 reflectors included.
2 réflecteurs inclus.
2 Reflektore inklusive.
2 riflettori inclusi.
2 reflectores incluidos

Especificaciones / Specifications

IP 67 CE ENERGY SAVING IK 08



Incluido / Included



Acabados / Finishes

Y4 Acero inoxidable
Stainless steel
Acier inoxydable
Rostfreier Stahl
Acciaio inossidabile
Aço inoxidável

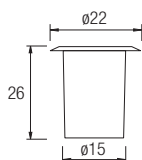

55-9323-Y4-37

G12 35W Halogenurs 40-80°C

IP 67 0.5m 2 263 IK 08

BAG Included

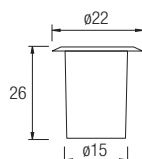
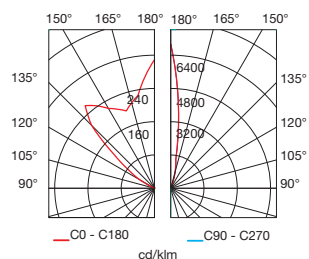

55-9187-Y4-37

G12 70W Halogenurs >80°C

IP 67 0.5m 2 263 IK 08

BAG Included

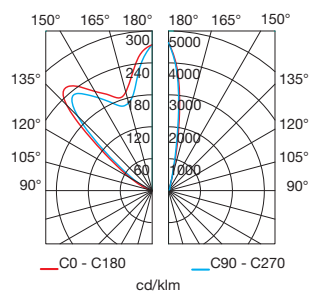

71-9453-Y4-Y4

Aro de acero inoxidable AISI 316 para 55-9187 y 55-9323
Stainless steel AISI 316 ring for 55-9187 and 55-9323

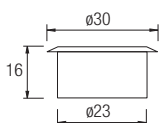

71-9187-Y4-37

Accesorio para 55-9187 y 55-9323
Accessory for 55-9187 and 55-9323

2 IK 08



La temperatura en la superficie externa es <70°.
The temperature of the external surface is <70°.
La température de la surface extérieure est <70°.
Die Temperatur an der äußeren Oberfläche beträgt <70°.
La temperatura sulla superficie esterna è <70°.
A temperatura na superfície extrna é <70°.

Materiales / Materials



Incluido / Included



Especificaciones / Specifications

IP 67 IK 08



Acabados / Finishes

Y4 Acero inoxidable
Stainless steel
Acier inoxydable
Rostfreier Stahl
Acciaio inossidabile
Aço inoxidável

(new)

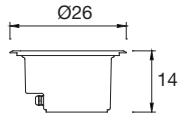

55-9430-Y4-T2

2 x GX24d-3 26W **>80°C**

IP 67 2 265 IK 08

2 x BAG **Included**

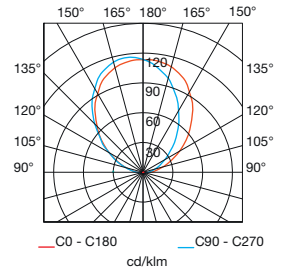

71-9454-Y4-Y4

Aro de acero inoxidable AISI 316 para 55-9430
Stainless steel AISI 316 ring for 55-9430

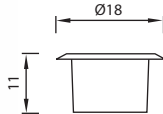

55-9337-Y4-37

G-53 75W Hal. 12V 71-9197 Pag. 258 **>80°C**

IP 67 4 264 IK 08

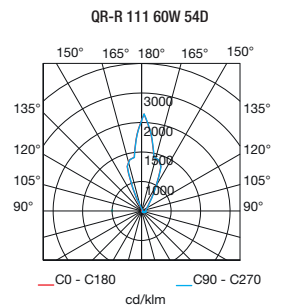

71-9452-Y4-Y4

Aro de acero inoxidable AISI 316 para 55-9337
Stainless steel AISI 316 ring for 55-9337

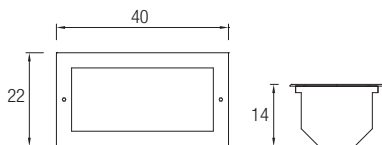

55-9384-Y4-37 (S)

2 x G-53 50W Hal. 12V 71-9197 Pag. 258 **>80°C**

IP 67 2 265 IK 08

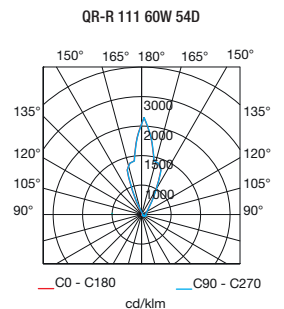

71-9197-05-05

Transformador estanco para lámparas halógenas. 230/12V AC-100W.
Water proof transformer for halogen bulbs. 230/12V AC - 100W.

IP 68 1 m 6



Materiales / Materials



Incluido / Included



Especificaciones / Specifications



Acabados / Finishes

Y4 Acero inoxidable
Stainless steel
Acier inoxydable
Rostfreier Stahl
Aço inoxidável

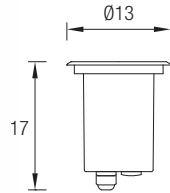

55-9280-Y4-37

- GU-10 max. 50W **>80°C**
- GU-10 max. 11W Fluorescent **40-80°C**
- GU-10 max. 5W LED **<40°C**

IP 67 $\varnothing_{0.5m}$ 8 \uparrow 264 IK 08

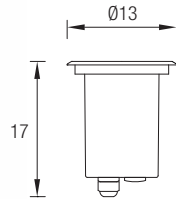
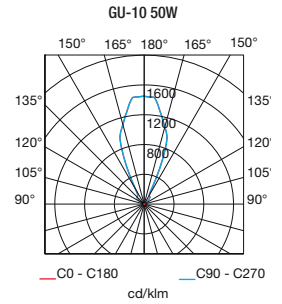

55-9394-Y4-37

- GU-10 max. 50W **>80°C**
- GU-10 max. 11W Fluorescent **40-80°C**
- GU-10 max. 5W LED **<40°C**

IP 67 4 \uparrow 264 IK 08

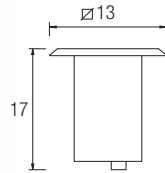
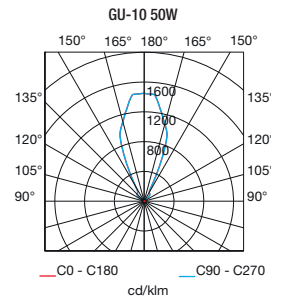

55-9281-Y4-37

- GU-10 max. 50W **>80°C**
- GU-10 max. 11W Fluorescent **40-80°C**
- GU-10 max. 5W LED **<40°C**

IP 67 $\varnothing_{0.5m}$ 8 \uparrow 264 IK 08

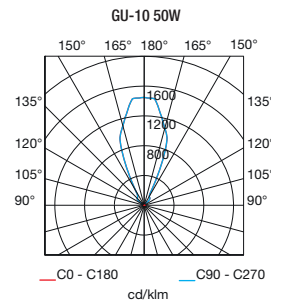

71-9449-Y4-Y4

Marco de acero inoxidable AISI 316 para 55-9281
Stainless steel AISI 316 frame for 55-9281

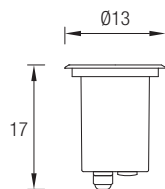

55-9380-Y4-37

- GU-10 max. 50W **>80°C**
- IP 67 $\varnothing_{0.5m}$ 4 \uparrow 264 IK 08

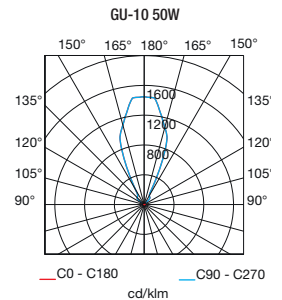

71-9448-Y4-Y4

Aro de acero inoxidable AISI 316 para 55-9380
Stainless steel AISI 316 ring for 55-9380



MUY IMPORTANTE consulte la tabla de usos y mantenimiento en la página 274
VERY IMPORTANT please consult the table on use and maintenance on page 274
TRÈS IMPORTANT consultez la table d'utilisation et de maintenance de la page 274

WICHTIG Bitte beachten Sie die Tabelle der Gebrauchs- und Instandhaltungsanweisungen auf Seite 274
MOLTO IMPORTANTE si consulti la tabella di uso e manutenzione a pagina 274
MUITO IMPORTANTE consulte a tabela de uso e manutenção na página 274

Materiales / Materials



Incluido / Included

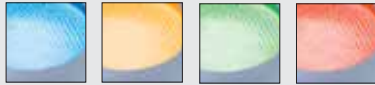

4 filtros de colores incorporados.
4 color filters included
4 filtres de couleurs inclus.
4 Farbfilter inklusive.
4 filtri di colore inclusi.
4 filtros de cor incluídos.

Especificaciones / Specifications

IP 67 CE ENERGY SAVING IK 08



Acabados / Finishes

Y4 Acero inoxidable
Stainless steel
Acier inoxydable
Rostfreier Stahl
Acciaio inossidabile
Aço inoxidável

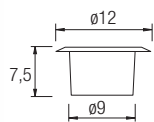

55-9184-Y4-37

GX 53 max. 9W - 230V 40-80°C

IP 67 8 262 IK 08

7W Included

ALU

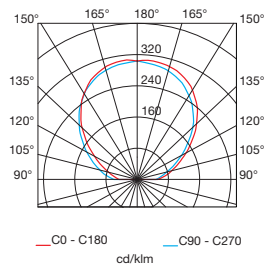

71-9450-Y4-Y4

Aro de acero inoxidable AISI 316 para 55-9184
Stainless steel AISI 316 ring for 55-9184

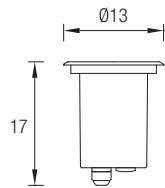

55-9282-Y4-T2

15 LEDs x 0,1 W 1,5W-230V <40°C

IP 67 8 264 IK 08

Included

TEC POLI

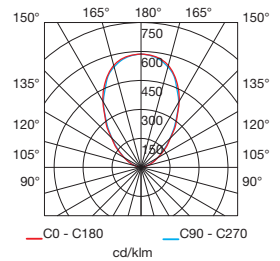

71-9448-Y4-Y4

Aro de acero inoxidable AISI 316 para 55-9282
Stainless steel AISI 316 ring for 55-9282

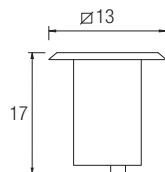

55-9283-Y4-T2

15 LEDs x 0,1 W 1,5W-230V <40°C

IP 67 8 264 IK 08

Included

TEC POLI

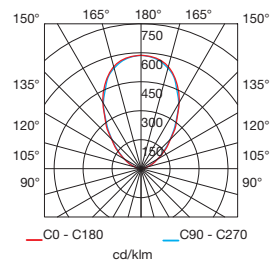

71-9449-Y4-Y4

Marco de acero inoxidable AISI 316 para 55-9283
Stainless steel AISI 316 frame for 55-9283

Materiales / Materials



Incluido / Included



Especificaciones / Specifications

IP 67 CE IK 08 ENERGY SAVING



Acabados / Finishes

Y4 Acero inoxidable
Stainless steel
Acier inoxydable
Rostfreier Stahl
Acciaio inossidabile
Aço inoxidável

37 Cristal templado.
Hardened glass.
Verre trempé.
Gehärtetes durchsichtiges
Glas.
Bicchiere indurito.
Vidrio endurecido.

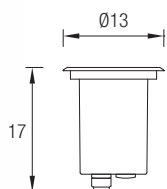

55-9284-37-37

- GU-10 max. 50W >80°C
- GU-10 max. 11W Fluorescent 40-80°C
- GU-10 max. 5W LED <40°C

IP 67 0.5m 8 ENERGY SAVING 264 IK 08

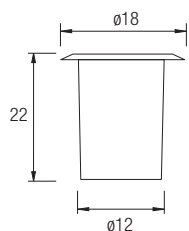
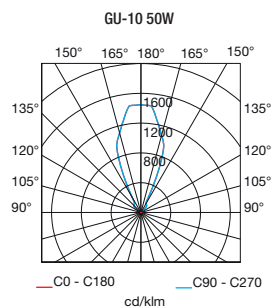

55-9186-Y4-37

- Par-30 E-27 max. 75W 40-80°C
- PL elect. E-27 max. 23W 40-80°C

IP 67 0.5m 8 ENERGY SAVING 262 IK 08

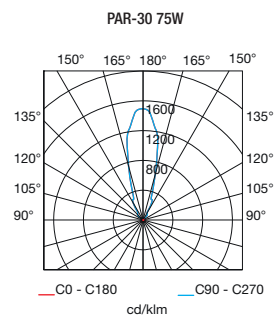

2 cristales incluidos.
2 glasses included.
2 verres compris.
Einbaukasten mit zwei Zusatzteilen aus Glas.
2 vetri inclusi.
2 vidros incluídos.



71-9452-Y4-Y4

Aro de acero inoxidable AISI 316 para 55-9186
Stainless steel AISI 316 ring for 55-9186



MUY IMPORTANTE consulte la tabla de usos y mantenimiento en la página 274
VERY IMPORTANT please consult the table on use and maintenance on page 274
TRÈS IMPORTANT consultez la table d'utilisation et de maintenance de la page 274

WICHTIG Bitte beachten Sie die Tabelle der Gebrauchs- und Instandhaltungsanweisungen auf Seite 274
MOLTO IMPORTANTE si consulti la tabella di uso e manutenzione a pagina 274
MUITO IMPORTANTE consulte a tabela de uso e manutenção na página 274



MUY IMPORTANTE consulte la tabla de usos y mantenimiento en la página 274
VERY IMPORTANT please consult the table on use and maintenance on page 274
TRÈS IMPORTANT consultez la table d'utilisation et de maintenance de la page 274

WICHTIG Bitte beachten Sie die Tabelle der Gebrauchs- und Instandhaltungsanweisungen auf Seite 274
MOLTO IMPORTANTE si consulti la tabella di uso e manutenzione a pagina 274
MUITO IMPORTANTE consulte a tabela de uso e manutenção na página 274

Materiales / Materials



Incluido / Included



Especificaciones / Specifications

IP 67 CE RF 850 ENERGY SAVING IK 08



Acabados / Finishes

Y4 Acero inoxidable
Stainless steel
Acier inoxydable
Rostfreier Stahl
Acciaio inossidabile
Aço inoxidável

(new)

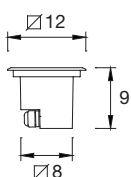

55-9435-Y4-37

3 x 1 W LED 230V 6000 °K <40°C

IP 67 2 ENERGY SAVING IK 08

Included

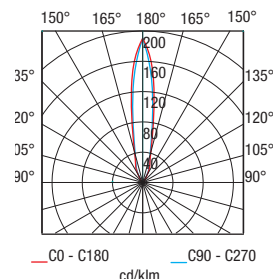

(new)

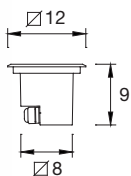

55-9443-Y4-37

3 x 1W RGB LED pag. 243 <40°C

IP 67 2 ENERGY SAVING IK 08

Este aparato sólo funciona con las referencias 71-9403 y 71-9404
This device just works with reference 71-9403 and 71-9404

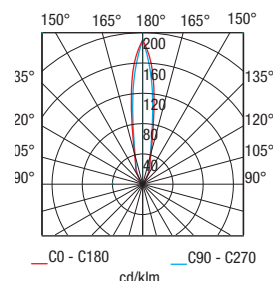

71-9451-Y4-Y4

Marco de acero inoxidable AISI 316 para 55-9435 y 55-9443
Stainless steel AISI 316 frame for 55-9435 and 55-9443

(new)

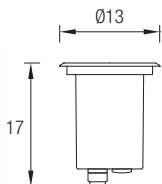

55-9437-Y4-37

3 x 1 W LED 230V 6000 °K <40°C

IP 67 2 ENERGY SAVING IK 08

Included

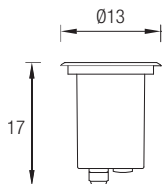
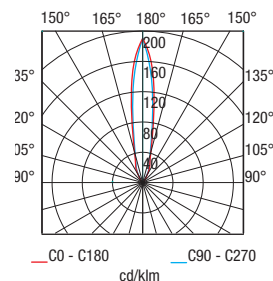

55-9382-Y4-37

3 x 1W RGB LED pag. 243 <40°C

IP 67 2 ENERGY SAVING IK 08

Este aparato sólo funciona con las referencias 71-9403 y 71-9404
This device just works with reference 71-9403 and 71-9404

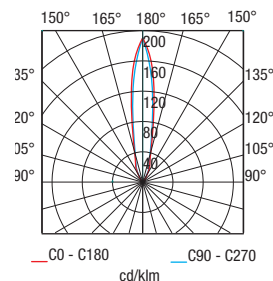

71-9448-Y4-Y4

Aro de acero inoxidable AISI 316 para 55-9437 y 55-9382
Stainless steel AISI 316 ring for 55-9437 and 55-9382



71-9403-34-34

Controlador RGB 230V hasta 50W
RGB Control System 230V up to 50W

IP 54 2



71-9404-34-34

Controlador RGB 230V hasta 100W
RGB Control System 230V up to 100W

IP 54 2

Materiales / Materials



Incluido / Included



Especificaciones / Specifications

IP 68 1 m CE



Acabados / Finishes

- 54 Aluminio anodizado
- Anodized aluminium
- Aluminium anodisé
- Eloxiertes Aluminium
- Alluminio anodizzato
- Amuminio anodizado

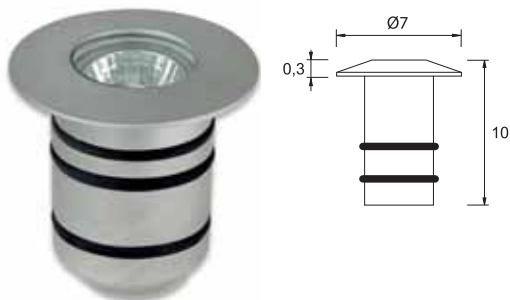

55-9255-54-37

MR11 max. 20W - 12V Halogen 71-9197 Pag. 258 >80°C

IP 68 1 m 8 263 IK 07

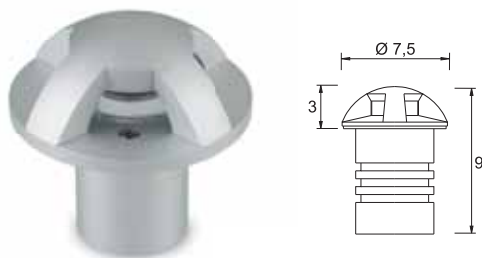
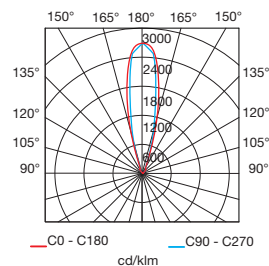

55-9257-54-M2

1 power LED 1W-3V DC 300mA 71-9278 Pag. 258 <40°C

IP 68 1 m 6 263 IK 10

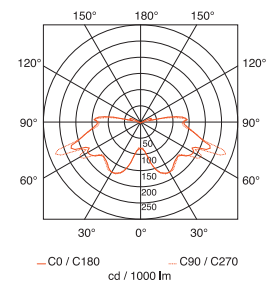

- 4 filtros de colores incorporados.
- 4 color filters included
- 4 filtres de couleurs inclus.
- 4 Farfilter inklusive.
- 4 filtri di colore inclusi.
- 4 filtros de cor incluídos.

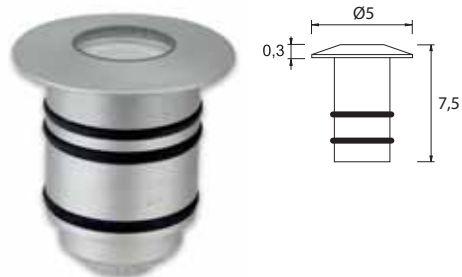

55-9254-54-37

1 power LED 1W-3V DC 300mA 71-9278 Pag. 258 <40°C

IP 68 1 m 8 263 IK 05

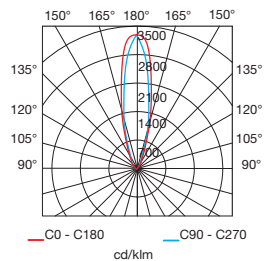

- 4 filtros de colores incorporados.
- 4 color filters included
- 4 filtres de couleurs inclus.
- 4 Farfilter inklusive.
- 4 filtri di colore inclusi.
- 4 filtros de cor incluídos.

Características / Specifications



Especificaciones / Specifications



Acabados / Finishes

- 54 Aluminio anodizado
- Anodized aluminium
- Aluminium anodisé
- Eloxiertes Aluminium
- Alluminio anodizzato
- Amuminio anodizado

Incluido / Included



4 filtros de colores incorporados.
4 color filters included
4 filtres de couleurs inclus.

4 Farfilter inklusive.
4 filtri di colore inclusi.
4 filtros de cor incluídos.

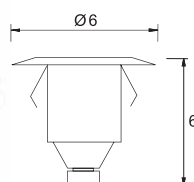

55-9243-54-B8 ■

12 LEDs x 0,1 W 1,2W-12V 71-9198 Pag. 258 <40°C

IP 66 20 263 IK 07

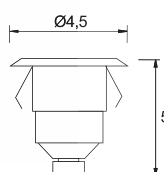
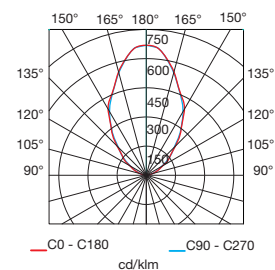

55-9242-54-B8 ■

6 LEDs x 0,1 W 0,6W-12V 71-9198 Pag. 258 <40°C

IP 66 36 263 IK 05



Aqua COLLECTION

- Colección de empotrables sumergibles realizados en acero inoxidable. Todos los modelos tienen un grado de protección IP 68. La serie cuenta con versiones halógenas, LED blanco y LEDS RGB.
- A collection of built-in waterproof luminaires, made of stainless steel. All models have IP68 rating. The collection includes halogens, white LEDs and RGB LEDs.
- Une collection de luminaires encastrables submersibles en acier inoxydable. Tous les modèles disposent d'un indice de protection IP 68. La série dispose de versions halogènes, LED blanc et LEDS RGB.
- Eine Kollektion von Einbau-Unterwasserleuchten, hergestellt aus rostfreiem Stahl. Von Einbau-Unterwasserleuchten IP 68 aus. Die Produktserie enthält halogene Versionen von weißen LED-Leuchten und RGB-LEDS.
- Collezione di elementi a incasso sommersibili realizzati in acciaio inossidabile. Tutti i modelli hanno un grado di protezione IP 68. La serie comprende versioni alogene, a LED bianchi e a LED RGB.
- Coleção de encastráveis submersíveis feitos em aço inoxidável. Todos os modelos têm um grau de protecção IP 68. A série tem versões de halogénio, LED branco e LED's RGB.



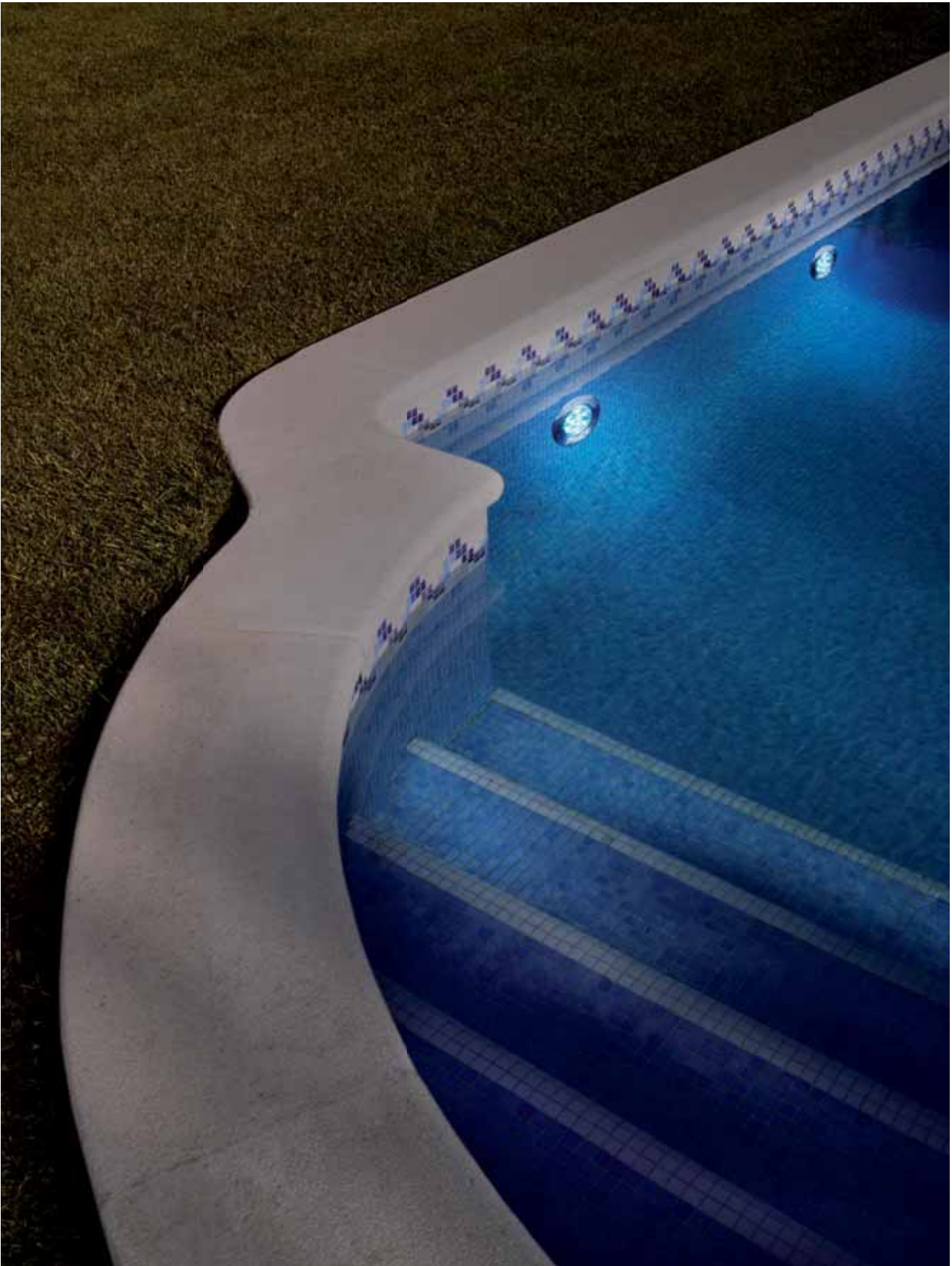

MUY IMPORTANTE consulte la tabla de usos y mantenimiento en la página 274
VERY IMPORTANT please consult the table on use and maintenance on page 274
TRÈS IMPORTANT consultez la table d'utilisation et de maintenance de la page 274

WICHTIG Bitte beachten Sie die Tabelle der Gebrauchs- und Instandhaltungsanweisungen auf Seite 274
MOLTO IMPORTANTE si consulti la tabella di uso e manutenzione a pagina 274
MUITO IMPORTANTE consulte a tabela de uso e manutenção na página 274

Materiales / Materials



Incluido / Included



Especificaciones / Specifications

IP 68 1 m CE RF 850° ENERGY SAVING IK 08



Acabados / Finishes

Y4 Acero inoxidable
Stainless steel
Acier inoxydable
Rostfreier Stahl
Acciaio inossidabile
Aço inoxidável

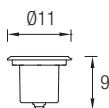

55-9377-Y4-37

3 x 1W WHITE LED 12V AC <40°C

IP 68 1 m 2 265 IK 08

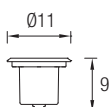
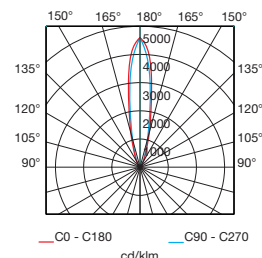

55-9378-Y4-37

3 x 1W RGB LED pag. 243 <40°C

IP 68 1 m 2 265 IK 08

Este aparato sólo funciona con las referencias 71-9403 y 71-9404
This device just works with reference 71-9403 and 71-9404

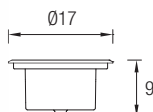
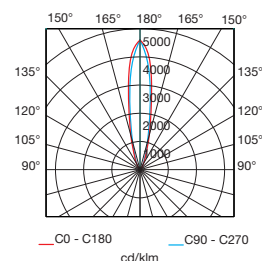

55-9354-Y4-37

9 x 1W WHITE LED 12V AC <40°C

IP 68 1 m 2 265 IK 08

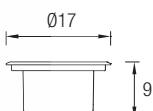
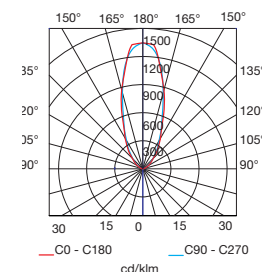

55-9355-Y4-37

9 x 1W RGB LED pag. 243 <40°C

IP 68 1 m 2 265 IK 08

Este aparato sólo funciona con las referencias 71-9403 y 71-9404
This device just works with reference 71-9403 and 71-9404

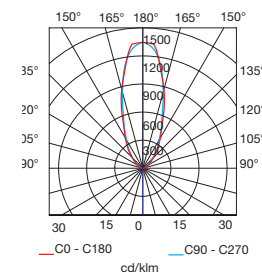

71-9396-05-05

Conector IP 68 3 vías forma "T" 3 polos.
IP 68 connection 3 ways T shape x 3 wires.



71-9397-05-05

Conector IP 68 2 vías 3 polos.
IP 68 connection 2 ways 3 wires.



71-9197-05-05

Transformador estanco. 230/12V AC-100W.
Water proof transformer. 230/12V AC - 100W.

IP 68 1 m 6



71-9403-34-34

Controlador RGB 230/12V AC-50W
RGB Control System RGB 230/12V AC-50W

IP 54 2



71-9404-34-34

Controlador RGB 230/12V AC-100W
RGB Control System RGB 230/12V AC-100W

IP 54 2



Materiales / Materials



Especificaciones / Specifications

IP 68 1 m CE RF 850° IK 08

Acabados / Finishes

Y4 Acero inoxidable
Stainless steel
Acier inoxydable
Rostfreier Stahl
Acciaio inossidabile
Aço inoxidável

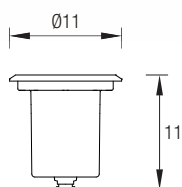

55-9245-Y4-37

MR-16 max. 50W - 12V **>80°C**

MR-16 max. 5W LED **<40°C**

IP 68 1 m 12 263 IK 08

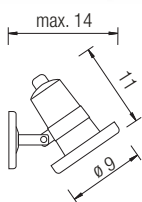
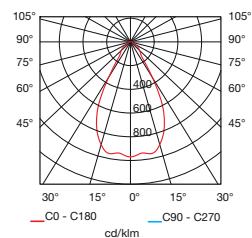

05-9245-Y4-37

MR-16 max. 50W - 12V

MR-16 max. 5W LED

IP 68 1 m 12 IK 08

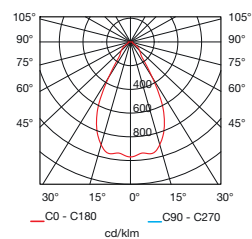

MUY IMPORTANTE consulte la tabla de usos y mantenimiento en la página 274
VERY IMPORTANT please consult the table on use and maintenance on page 274
TRÈS IMPORTANT consultez la table d'utilisation et de maintenance de la page 274

WICHTIG Bitte beachten Sie die Tabelle der Gebrauchs- und Instandhaltungsanweisungen auf Seite 274
MOLTO IMPORTANTE si consulti la tabella di uso e manutenzione a pagina 274
MUITO IMPORTANTE consulte a tabela de uso e manutenção na página 274



71-9197-05-05

Transformador estanco para lámparas halógenas. 230/12V AC-100W.
Water proof transformer for halogen bulbs. 230/12V AC - 100W.

IP 68 1 m 6



Xena COLLECTION [®]

- Colección de empotrables y balizas especialmente diseñada para la señalización de zonas de paso. Cuerpo en tecnopolímero de altas prestaciones y protectores en aluminio de alta calidad y policarbonato; por lo que presentan un alto grado de resistencia mecánica y a la corrosión.
- Collection of embedded and beacons specially designed for marking pathways. Body made of high-pressure technopolymer and protectors made of high quality aluminium and polycarbonate, providing a high level of mechanical resistance and rust-resistance.
- Collection d'encastables et de bornes spécialement conçue pour la signalisation de zones de passage. Corps en technopolymère aux hautes prestations et protecteurs en aluminium de haute qualité et polycarbonate qui leur donnent un haut degré de résistance mécanique et à la corrosion.
- Kollektion von Einbau- und Pollerleuchten, die besonders zur Signalisierung in Durchgangszonen vorgesehen sind. Körper aus hochleistungem Technopolymer und Schutzkappen aus hochwertigem Aluminium und Polycarbonat, weshalb die Leuchten eine hohe mechanische Beständigkeit aufweisen und sehr widerstandsfähig gegen Korrosion sind.
- Collezione di luminarie da incasso e di segnalazione progettata specialmente per la segnaletica di zone di passaggio. Corpo in tecnopolimero ad alte prestazioni ed elementi di protezione in alluminio di alta qualità e policarbonato, dotati di un alto grado di resistenza meccanica e alla corrosione.
- Coleção de encastráveis e balizadores especialmente concebida para a sinalização de zonas de passagem. Corpo em tecnopolímero de elevadas prestações e protectores em alumínio de alta qualidade e policarbonato, pelo que apresentam um alto grau de resistência mecânica e à corrosão.

[®] Registration number: Pending





Materiales / Materials



Especificaciones / Specifications



5000kg

Acabados / Finishes

M3 Difusor de policarbonato mate
 Matt polycarbonate diffuser.
 Difuseur en polycarbonate mat.
 Diffusore di polycarbonato matt.
 Matter Diffusor aus Polykarbonat
 Difusor de policarbonato mate.

(new)

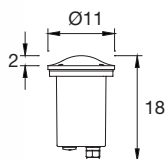

55-9421-M3-M3 ■

GU-10 max. 11W Fluorescent <40°C

GU-10 max. 5W LED <40°C

IP 67 8 265 IK 10

(new)

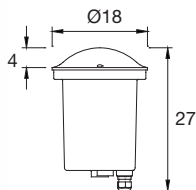

55-9425-M3-M3 ■

PL elect. E-27 max. 20W <40°C

IP 67 6 265 IK 10



Materiales / Materials



Especificaciones / Specifications



5000kg

Acabados / Finishes

■ 34 Gris	■ Z5 Gris urbano
Grey	Urban grey
Gris	Gris urbain
Grau	Stadtgrau
Grigio	Grigio urbano
Cinzeno	Cinzeno urbano

(New)

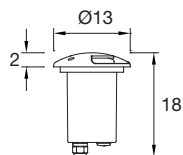

55-9423-34-T2 ■
55-9423-Z5-T2 ■

12 x 0,1W LED 4200°K <40°C

IP 67 264 IK 10

Included

12 x 0,1W LED **Included**

(New)

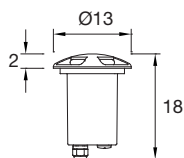

55-9424-34-T2 ■
55-9424-Z5-T2 ■

12 x 0,1W LED 4200°K <40°C

IP 67 264 IK 10

Included

12 x 0,1W LED **Included**

(New)

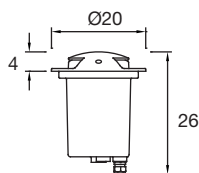

55-9427-34-T2 ■
55-9427-Z5-T2 ■

PL elect. E-27 max. 20W 40-80°C

IP 67 265 IK 10

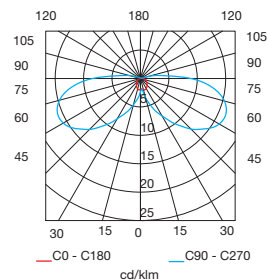

(New)

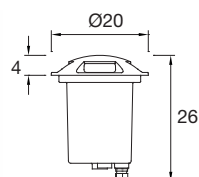

55-9428-34-T2 ■
55-9428-Z5-T2 ■

PL elect. E-27 max. 20W 40-80°C

IP 67 265 IK 10

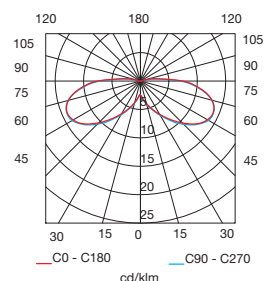

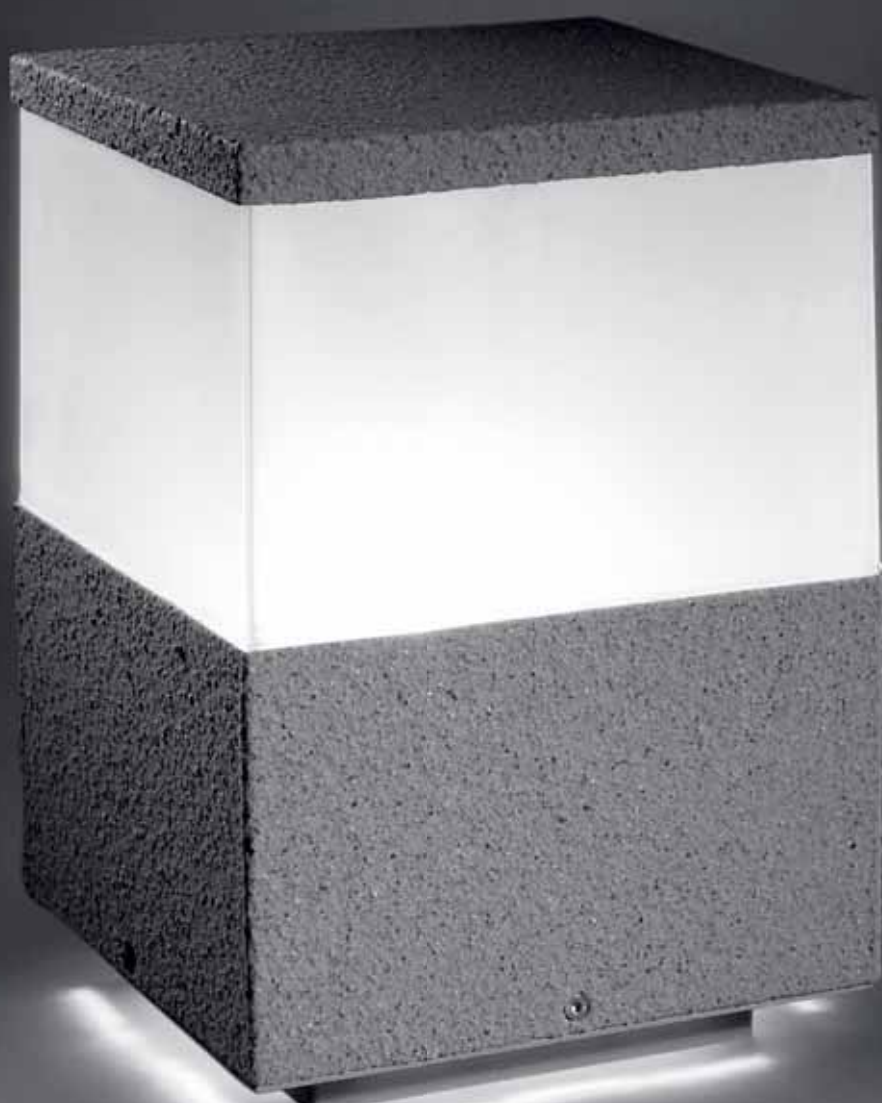



Cubik COLLECTION

- Colección de sobremuros realizada en aluminio extrusionado en acabados pintura epoxi o granito con difusor de policarbonato satinado. Los modelos, que están disponibles en dos tamaños, favorecen el ahorro energético y la anticontaminación lumínica.
- Collection of outdoor lanterns made of extruded aluminum with granite or epoxy paint with a glazed polycarbonate diffuser. The models, which are available in two sizes, favor energy savings and anti-light pollution.
- Collection de lampadaires réalisée en aluminium extrudé, finition peinture époxy ou granit, diffuseur en polycarbonate satiné. Les modèles, disponibles en deux tailles, favorisent l'économie d'énergie et l'antipollution lumineuse.
- Eine Kollektion von Mauerleuchten, die aus extrudiertem Aluminium hergestellt werden und in den Ausfertigungsarten Epoxy-Lackierung oder Granit mit Lichtstreuer aus satiniertem Polycarbonat erhältlich sind. Die Modelle stehen in verschiedenen Größen zur Verfügung und tragen zur Energieeinsparung sowie zur Verringerung der Lichtbelastung bei.
- Collezione di sopramuro realizzata in alluminio estruso, finitura granito o pintura epoxi con diffusore in policarbonato satinato. I modelli, disponibili in due dimensioni, favoriscono il risparmio energetico e antinquinamento luminoso.
- Coleção para parede feita em alumínio extrusionado com acabamento granito ou pintura epoxi com difusor de policarbonato acetinado. Os modelos, que estão disponíveis em dois tamanhos, favorecem a poupança de energia e anti-contaminação luminosa.



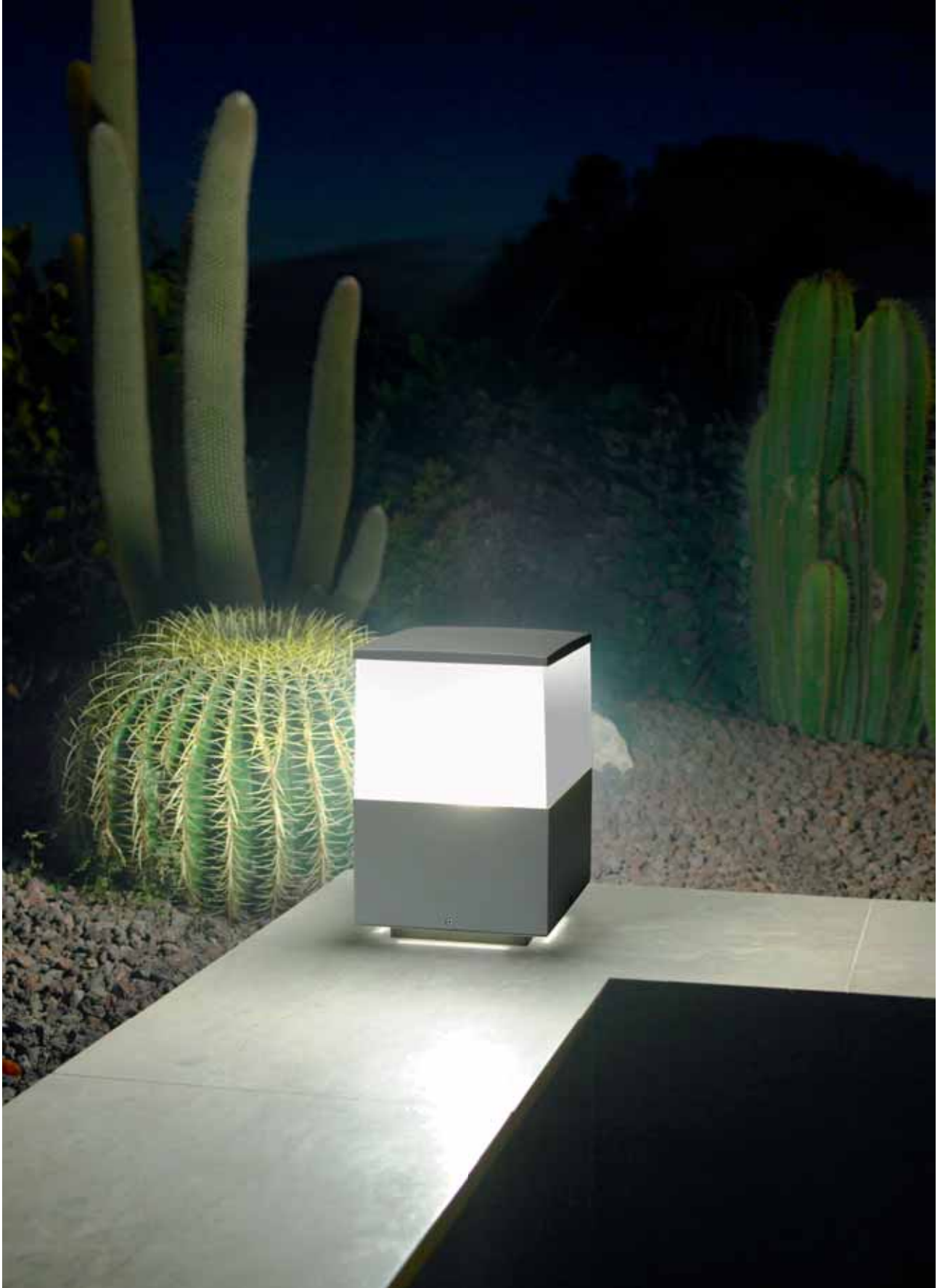

Materiales / Materials



Especificaciones / Specifications



Acabados / Finishes

■ 34 Gris Grey Gris Grau Grigio Cinzeno	■ K7 Gris acabado piedra Stone grey Gris pierre Steingrau Grigio pietra Cinzeno pedra	■ Z5 Gris urbano Urban grey Gris urbain Stadtgrau Grigio urbano Cinzeno urbano
--	--	---

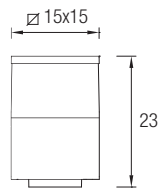

10-9386-34-M3 ■ (new)

10-9386-K7-M3 ■

10-9386-Z5-M3 ■ (new)

⦿ E-27 max. 60W

⦿ PL elect. E-27 max. 18W

IP 54 ⚡ 4 🌿 IK 10

➡ 13W **Included**

PL 13W

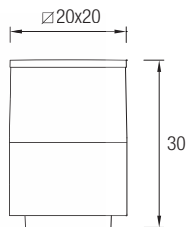
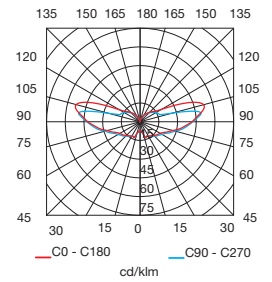

10-9387-34-M3 ■ (new)

10-9387-K7-M3 ■

10-9387-Z5-M3 ■ (new)

⦿ E-27 max. 100W

⦿ PL elect. E-27 max. 23W

IP 54 ⚡ 4 🌿 IK 10

➡ 18W **Included**

PL 18W

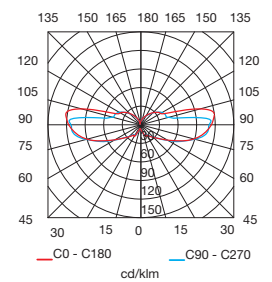

ODIN

Materiales / Materials



Especificaciones / Specifications



Acabados / Finishes

- Z5 Gris urbano
- Urban grey
- Gris urbain
- Stadtgrau
- Grigio urbano
- Cinzeno urbano

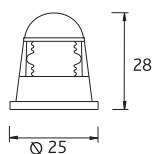

10-9116-Z5-M2 ■

 E-27 max.60W

 PL elect. E-27 max. 23W

IP 54   2  261 

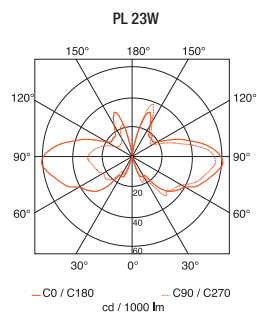

BRIDGE

Materiales / Materials



Especificaciones / Specifications

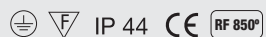

Acabados / Finishes

 Y4 Acero inoxidable
Stainless steel
Acier inoxydable
Rostfreier Stahl
Acciaio inossidabile
Aço inoxidável



121
Bridge

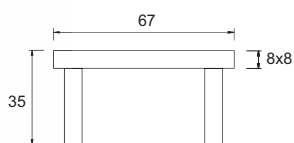

55-9263-Y4-37  (S)

 2G11 max 36W

IP 44  2  263

 36W +  **Included**



Quadra COLLECTION

- Colección de diseño contemporáneo realizada en aluminio extrusionado y en acabado plata. Una serie formada por dos balizas pensadas para la señalización de zonas de paso exteriores. Los modelos, de baja contaminación lumínica, se presentan con equipos incluidos. Además, pueden utilizar lámparas fluorescentes o halogenuros metálicos.
- Contemporary design collection made of extruded aluminum and with silver finish. A series made up of two beacon designed for signaling outdoor traffic areas. The models, which emit low levels of light pollution come with included equipment. Additionally, they may use fluorescent lamps or metal halide lamps.
- Design contemporain pour cette collection réalisée en aluminium extrudé et en finition argent. Une série constituée de deux balises pensées pour la signalisation de zones de passages extérieurs. Les modèles, à pollution lumineuse réduite, comprennent des équipements électroniques. De plus, ils peuvent recevoir des lampes halogènes ou des lampes à halogénure métallique.
- Eine Kollektion in zeitgemäßem Design aus stranggepresstem Aluminium und in Silber ausgefertigt. Die Serie besteht aus zwei Signallichtern, die zur Leuchtkezeichnung in Außenbereichen eingesetzt werden können. Die Modelle verursachen eine niedrige Lichtverschmutzung und schließen die entsprechenden Anlagen ein. Darüber hinaus können damit Leuchtröhren und metallische Halogenidlampen benutzt werden.
- Collezione dal design contemporaneo realizzata in alluminio estruso e con finitura argento. Una serie composta da due riflettori pensati per illuminare le aree di passaggio esterne. I modelli, a ridotto inquinamento luminoso, sono forniti completi di attrezzature. Possono inoltre utilizzare lampade fluorescenti o ad alogenuri metallici.
- Coleção de concepção contemporânea feita em alumínio extrusionado e com acabamento cor prata. Uma série composta por dois focos luminosos pensados para a sinalização de zonas de passagem exteriores. Os modelos, de baixa contaminação luminosa, apresentam-se com equipamentos incluídos. Além disso, podem utilizar lâmpadas fluorescentes ou halogenetos metálicos.

 Registration number: 001091375-026



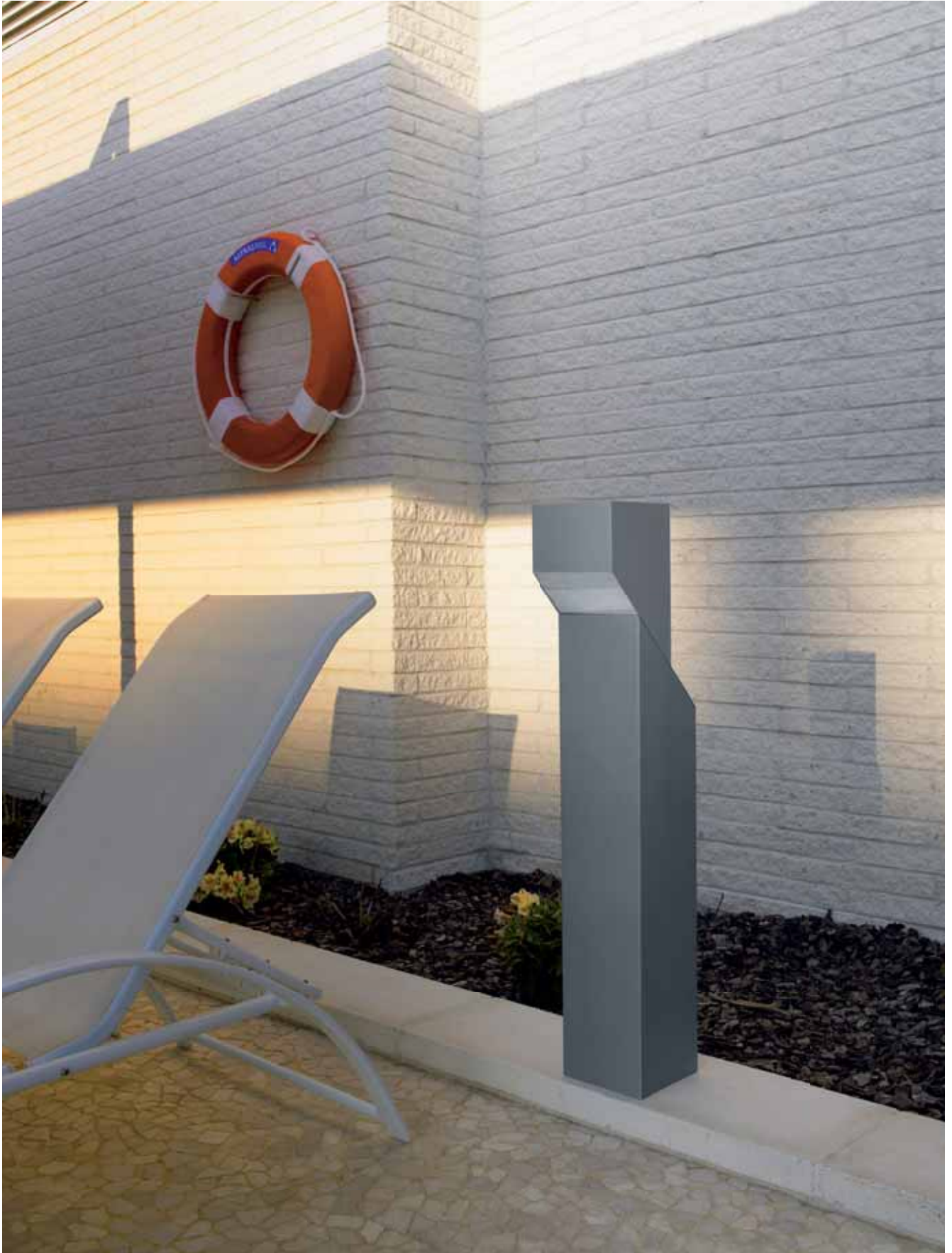

Materiales / Materials



Especificaciones / Specifications

⚡ F IP 44 CE RF 850° ENERGY SAVING IK 03

Acabados / Finishes

■ 34 Gris
Grey
Gris
Grau
Grigio
Cinzento

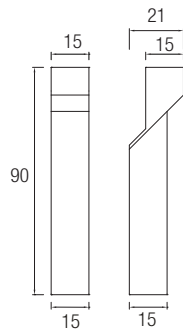

55-9361-34-T2 ■ (S)

G12 70W Halogenurs

IP 44 0.5m 2 ENERGY SAVING 265 IK 03

BAG Included

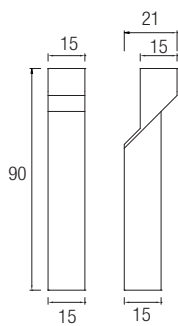
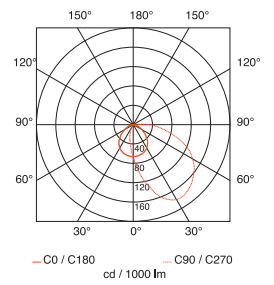

55-9374-34-T2 ■

2 x GX24d-3 26W Fluo

IP 44 2 ENERGY SAVING 265 IK 03

BAG Included

Nott COLLECTION

- Colección realizada en aluminio extrusionado y difusor de policarbonato satinado. Serie de diseño moderno formada por dos balizas con dos acabados diferentes, preparadas para el uso de lámparas de bajo consumo.
- A collection made of extruded aluminium and satin polycarbonate diffuser. A modern design collection with two beacons in two different finishes, prepared for the use of energy-saving lamps.
- Une collection en aluminium extrudé et diffuseur en polycarbonate satiné. Une série au design moderne composée de deux balises de finitions distinctes permettant l'utilisation de lampes basse consommation.
- Eine Kollektion, hergestellt aus extrudiertem Aluminium mit Diffusor aus satiniertem Polykarbonat. Es ist eine moderne Produktserie, die aus zwei Leuchtbacken unterschiedlicher Ausführungen besteht und für den Gebrauch von Energiesparlampen geeignet ist.
- Collezione realizzata in alluminio estruso e diffusore in policarbonato satinato. Serie dal design moderno formata da due faretti con due rifiniture differenti, predisposte per l'uso di lampade a basso consumo.
- Coleção feita em alumínio extrusionado e difusor de policarbonato acetinado. Série de concepção moderna composta por duas sinalizações com dois acabamentos diferentes, preparadas para o uso de lâmpadas de baixo consumo.



Materiales / Materials



Especificaciones / Specifications

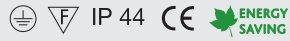

Acabados / Finishes

■ 34 Gris Grey Gris Grau Grigio Cinzento	■ Z5 Gris urbano Urban grey Gris urbain Stadtgrau Grigio urbano Cinzento urbano
---	--

(new)

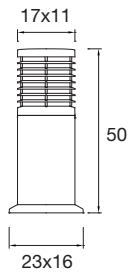

55-9357-34-M3 ■
55-9357-Z5-M3 ■

⦿ E-27 max. 30W

⦿ PL elect. E-27 max.23W

IP 44 4 265 IK 08

(new)

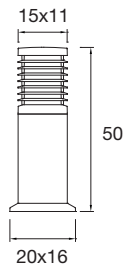

55-9358-34-M3 ■
55-9358-Z5-M3 ■

⦿ E-27 max. 30W

⦿ PL elect. E-27 max.23W

IP 44 4 265 IK 08



Balizas COLLECTION [®]

- Colección de balizas realizadas en aluminio. La serie está disponible en tres dimensiones y acabados diferentes. Una colección ideal para la iluminación de zonas ajardinadas, disponible para usar lámparas fluorescentes y halógenos metálicos.
- A collection of beacons made with aluminium. The collection is available in three different sizes and finishes. It is an ideal collection to light gardens, available for the use of fluorescent and metal halide lamps.
- Une collection de balises en aluminium. La série présente trois tailles et plusieurs types de finitions. Une collection idéale pour l'illumination des espaces verts et jardins, permettant l'utilisation de lampes fluorescentes et halogénures métalliques.
- Eine Kollektion von Leuchtbaken, Aluminium. Die Produktserie ist in drei Größen und in verschiedenen Ausführungen erhältlich. Sie ist besonders für die Beleuchtung von Gartenanlagen geeignet und für den Gebrauch von Leuchtstoff- und Halogenmetaldampflampen hergestellt worden.
- Collezione di faretti realizzati in alluminio. La serie è disponibile in tre dimensioni e rifiniture differenti. Una collezione ideale per l'illuminazione di zone a giardino, disponibile per l'uso con lampade fluorescenti e ad alogenuri metallici.
- Coleção de sinalizações feitas em alumínio. A série está disponível em três dimensões e acabamentos diferentes. Uma coleção ideal para iluminação de zonas ajardinadas, disponível com lâmpadas fluorescentes e halógenos metálicos.

[®] Registration number: 000966874-026 / 000966874-028



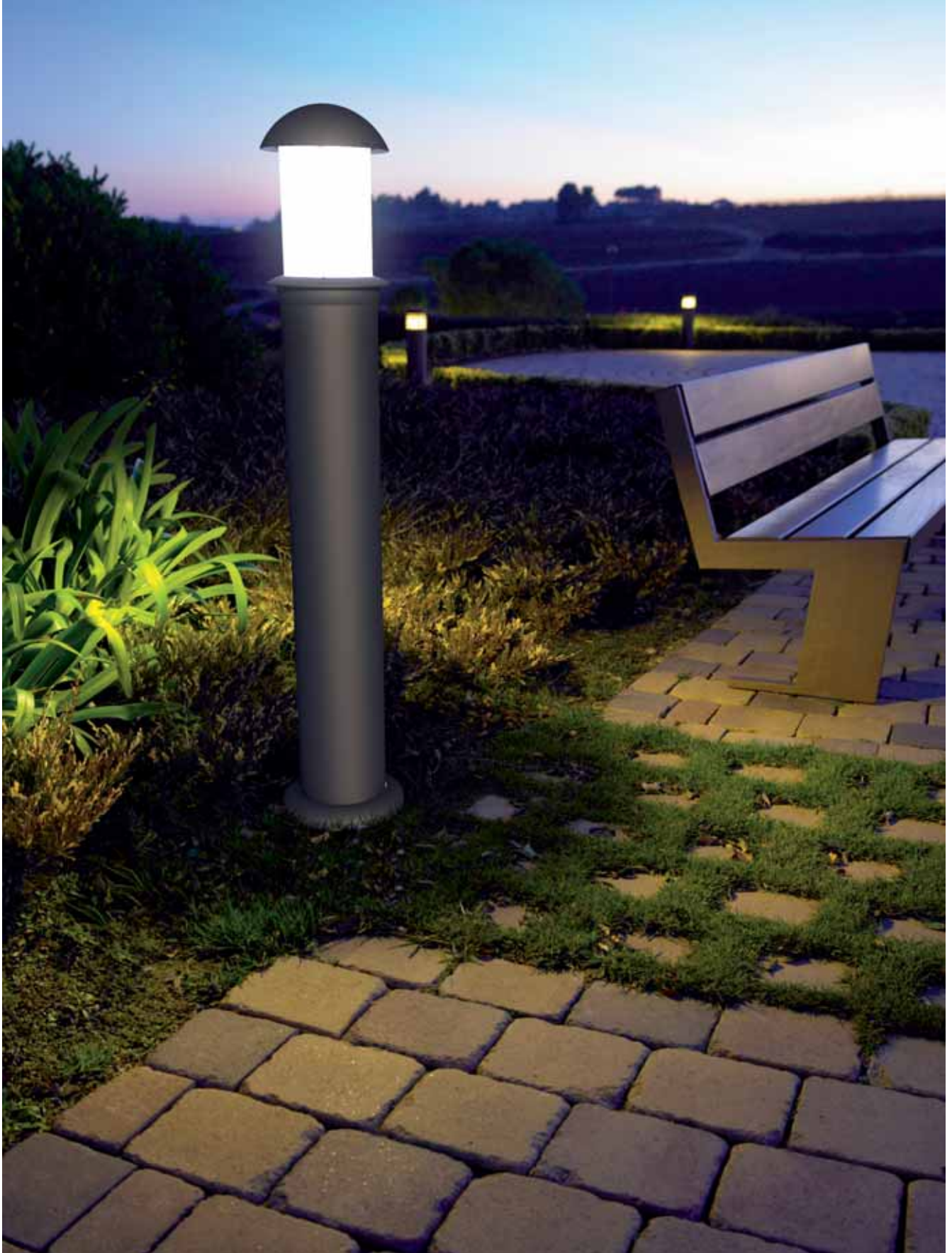

Materiales / Materials



Especificaciones / Specifications



Acabados / Finishes

■ Z5 Gris urbano Urban grey	■ 34 Gris Grey
Gris urbain Stadtgrau	Gris Grau
Grigio urbano Cinzeno urbano	Grigio Cinzeno

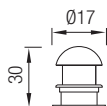

55-9334-34-M3 ■

55-9334-Z5-M3 ■

E-27 max. 100W

PL elect. E-27 max. 23W

IP 44 6 264 IK 08

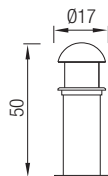
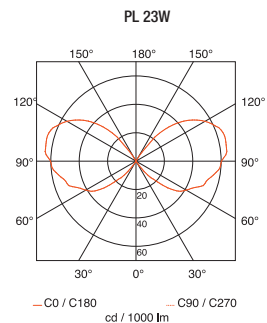

55-9335-34-M3 ■

55-9335-Z5-M3 ■

E-27 max. 100W

PL elect. E-27 max. 23W

IP 44 4 264 IK 08

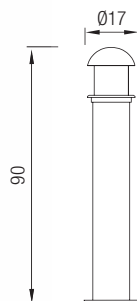
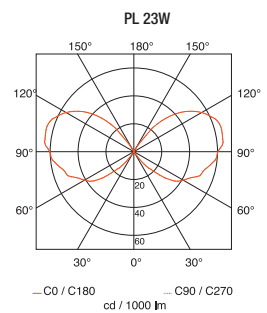

55-9336-34-M3 ■

55-9336-Z5-M3 ■

E-27 max. 100W

PL elect. E-27 max. 23W

IP 44 4 264 IK 08

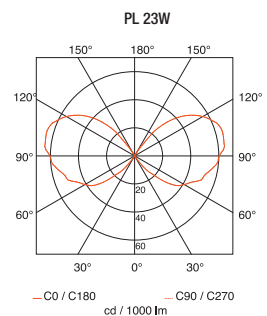



Materiales / Materials

ALU
PUR

PC
STN

Especificaciones / Specifications

⊕ ⚡ IP 44 CE ENERGY SAVING

Acabados / Finishes

■ 34 Gris
Grey
Gris
Grau
Grigio
Cinzeno

■ J6 Marrón
Brown
Marron
Braun
Marrone
Castanho

■ Z5 Gris urbano
Urban grey
Gris urbain
Stadtgrau
Grigio urbano
Cinzeno urbano



55-9318-34-M3 ■
55-9318-J6-M3 ■ (NEW)
55-9318-Z5-M3 ■

⊕ E-27 max. 100W
⊕ PL elect. E-27 max. 23W

IP 44 ☒ 6 ENERGY SAVING 264 IK 08

PL 23W

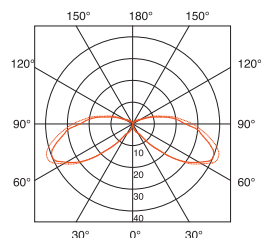

— C0 / C180 — C90 / C270
cd / 1000 lm

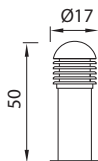

55-9319-34-M3 ■
55-9319-J6-M3 ■ (NEW)
55-9319-Z5-M3 ■

⊕ E-27 max. 100W
⊕ PL elect. E-27 max. 23W

IP 44 ☒ 4 ENERGY SAVING 264 IK 08

PL 23W

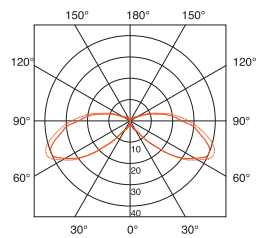

— C0 / C180 — C90 / C270
cd / 1000 lm

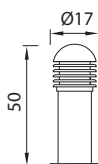

55-9342-34-M3 ■
55-9342-J6-M3 ■ (NEW)
55-9342-Z5-M3 ■

⊕ G12 70W Halogenurs

IP 44 ☒ 4 264

Included

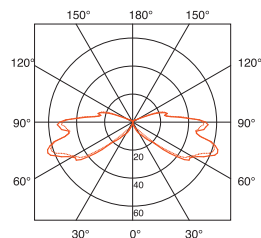

— C0 / C180 — C90 / C270
cd / 1000 lm

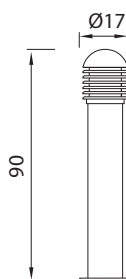

55-9320-34-M3 ■
55-9320-J6-M3 ■ (NEW)
55-9320-Z5-M3 ■

⊕ E-27 max. 100W
⊕ PL elect. E-27 max. 23W

IP 44 ☒ 4 ENERGY SAVING 264 IK 08

PL 23W

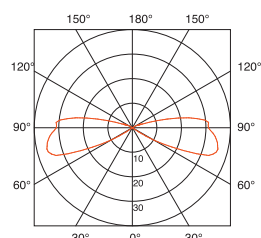

— C0 / C180 — C90 / C270
cd / 1000 lm

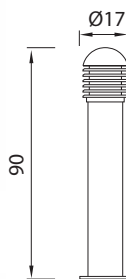

55-9343-34-M3 ■
55-9343-J6-M3 ■ (NEW)
55-9343-Z5-M3 ■

⊕ G12 70W Halogenurs

IP 44 ☒ 4 ENERGY SAVING 264

Included

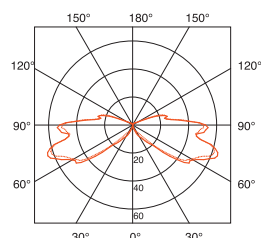

— C0 / C180 — C90 / C270
cd / 1000 lm

Materiales / Materials	Especificaciones / Specifications	Acabados / Finishes												
		<table border="0"> <tr> <td> 05 Negro</td> <td> 34 Gris</td> </tr> <tr> <td>Black</td> <td>Grey</td> </tr> <tr> <td>Noir</td> <td>Gris</td> </tr> <tr> <td>Schwarz</td> <td>Grau</td> </tr> <tr> <td>Nero</td> <td>Grigio</td> </tr> <tr> <td>Preto</td> <td>Cinzentu</td> </tr> </table>	05 Negro	34 Gris	Black	Grey	Noir	Gris	Schwarz	Grau	Nero	Grigio	Preto	Cinzentu
05 Negro	34 Gris													
Black	Grey													
Noir	Gris													
Schwarz	Grau													
Nero	Grigio													
Preto	Cinzentu													

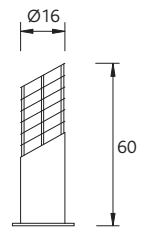

55-8956-05-M1 ■
55-8956-34-M1 ■

E-27 max. 100W
 PL elect. E-27 max. 23W

IP 44 4 262

MIDAS

Materiales / Materials	Especificaciones / Specifications	Acabados / Finishes						
		<table border="0"> <tr> <td> 18 Marrón óxido</td> </tr> <tr> <td>Rusted/oxide brown</td> </tr> <tr> <td>Rouille</td> </tr> <tr> <td>Rostbraun</td> </tr> <tr> <td>Marrone ossido</td> </tr> <tr> <td>Marrom óxido</td> </tr> </table>	18 Marrón óxido	Rusted/oxide brown	Rouille	Rostbraun	Marrone ossido	Marrom óxido
18 Marrón óxido								
Rusted/oxide brown								
Rouille								
Rostbraun								
Marrone ossido								
Marrom óxido								

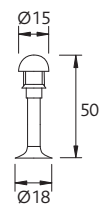

10-9183-18-B8 ■ (S)

E-27 100W-HAL
 PL elect. E-27 max. 23W

IP 44 4 261

13W **Included**

MICENAS

Características / Specifications



Especificaciones / Specifications



Acabados / Finishes



-  34 Gris
- Grey
- Gris
- Grau
- Grigio
- Cinzeno

135

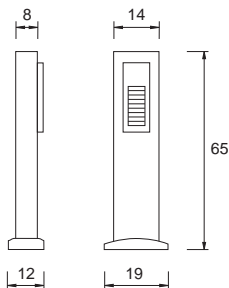
Micensa



55-9128-34-T2 ■ (S)

-  GU-10 max. 50W
-  GU-10 max. 11W Fluorescent
-  GU-10 max. 5W LED

 IP 44   2  IK 04

 **OSRAM 50W** **Included**

URANO



Materiales / Materials

ALU
EXTR

PC
TRAN

Especificaciones / Specifications

⊕ ⚡ IP 54 CE ENERGY SAVING

Acabados / Finishes

- Z5 Gris urbano
- Urban grey
- Gris urbain
- Stadtgrau
- Grigio urbano
- Cinzeno urbano

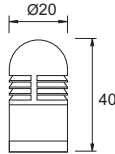

10-9237-Z5-M2 ■ (S)

⦿ E-27 max. 150W

⦿ PL elect. E-27 max. 30W

IP 54 ☒ 4 🛠 261 🌿

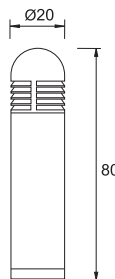
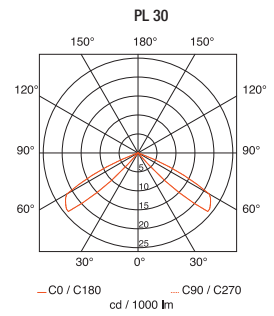

55-9237-Z5-M2 ■

⦿ E-27 max. 150W

⦿ PL elect. E-27 max. 30W

IP 54 ☒ 2 🛠 261 🌿

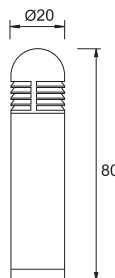
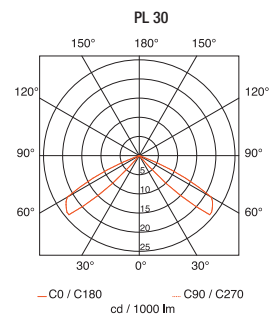

55-9272-Z5-M2 ■

⦿ G12 70W Halogenurs

IP 54 ☒ 2 🛠 261 🌿

Included

MERCURIO

Materiales / Materials



Especificaciones / Specifications

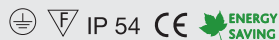

Acabados / Finishes

- Z5 Gris urbano
- Urban grey
- Gris urbain
- Stadtgrau
- Grigio urbano
- Cinzenito urbano



137

Mercurio

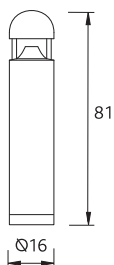

55-9125-Z5-M2 ■

E-27 max. 100W

Mezcla E-27 max. 160W

PL elect. E-27 max. 23W

IP 54 2 262

23W **Included**

PL 23W

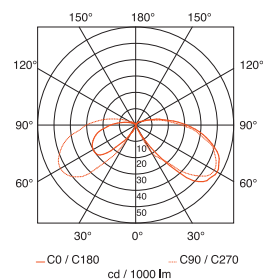



Electra COLLECTION

- Amplia colección de diseño contemporáneo formada por aplique, sobremuro y baliza. Una serie realizada en acero inoxidable apta para el uso de lámparas de bajo consumo.
- A large contemporary-design collection of wall fixtures, lanterns and beacons. They are made of stainless steel, suitable for the use of energy-saving lamps.
- Une vaste collection au design contemporain composée de balises, appliques et bornes. Une série en acier inoxydable permettant l'utilisation de lampes basse consommation.
- Umfangreiche Kollektion von modernem Design, bestehend aus Wandlampen, Lampen für Außenwände und Bakenleuchten. Die Produktserie ist aus rostfreiem Stahl hergestellt und eignet sich zur Benutzung von Energiesparlampen.
- Ampia collezione dal design contemporáneo formada da applique, base da muro e faretto. Una serie realizzata in acciaio inossidabile adatta all'uso di lampade a basso consumo.
- Ampla coleção de concepção contemporânea formada por aplique, sobremuro e baliza. Uma série efectuada em aço inoxidável apta para o uso de lâmpadas de baixo consumo.





Materiales / Materials



Especificaciones / Specifications



Acabados / Finishes

Y4 Acero inoxidable
Stainless steel
Acier inoxydable
Rostfreier Stahl
Acciaio inossidabile
Aço inoxidável

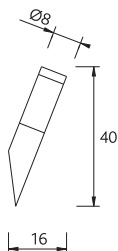

05-8790-Y4-M1

PL elect. E-27 Max. 23W

IP 55 4

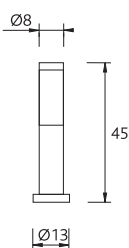

10-8790-Y4-M1

PL elect. E-27 Max. 23W

IP 55 4 261

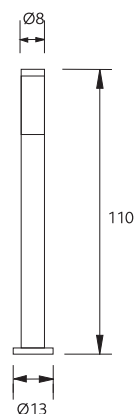

55-8790-Y4-M1

PL elect. E-27 Max. 23W

IP 55 2 261

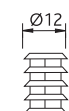

55-8791-Y4-Y4

Kit reflector / Spotlight kit

2



MUY IMPORTANTE consulte la tabla de usos y mantenimiento en la página 274
VERY IMPORTANT please consult the table on use and maintenance on page 274
TRÈS IMPORTANT consultez la table d'utilisation et de maintenance de la page 274

WICHTIG Bitte beachten Sie die Tabelle der Gebrauchs- und Instandhaltungsanweisungen auf Seite 274
MOLTO IMPORTANTE si consulti la tabella di uso e manutenzione a pagina 274
MUITO IMPORTANTE consulte a tabela de uso e manutenção na página 274



Materiales / Materials



Especificaciones / Specifications



Acabados / Finishes

- J6 Marrón
- Brown
- Marron
- Braun
- Marrone
- Castanho

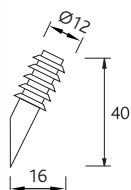

05-9333-J6-M1 ■

PL elect. E-27 max. 23W

IP 55 ☒ 4 🍀

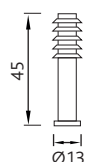

10-9333-J6-M1 ■

PL elect. E-27 max. 23W

IP 55 ☒ 4 🍀 261



55-9333-J6-M1 ■

PL elect. E-27 max. 23W

IP 55 ☒ 2 🍀 261

PRIAP



144

Priap

Priap COLLECTION

- Colección de acero inoxidable y difusor de policarbonato. Adecuada para uso con lámparas de bajo consumo, presenta un diseño estilizado y atractivo.
- A collection made of stainless steel and a polycarbonate diffuser. It is suitable for the use of energy-saving lamps. It has an attractive and stylised design.
- Une collection en acier inoxydable et diffuseur en polycarbonate. Compatible avec l'utilisation de lampes basse consommation, cette collection présente un design stylisé et attractif.
- Die Kollektion ist aus rostfreiem Stahl hergestellt und verfügt über einen Diffusor aus Polykarbonat. Sie eignet sich zum Gebrauch von Energiesparlampen und besitzt ein stilisiertes und sehr attraktives Design.
- Collezione in acciaio inossidabile con diffusore in policarbonato. Adeguata all'uso di lampade a basso consumo, presenta un design stilizzato e attraente.
- Colecção de aço inoxidável e difusor de policarbonato. Adequada para uso com lâmpadas de baixo consumo, apresenta uma concepção estilizada e atractiva.



Materiales / Materials



Especificaciones / Specifications

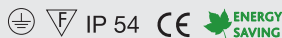

Acabados / Finishes

Y4 Acero inoxidable
Stainless steel
Acier inoxydable
Rostfreier Stahl
Acciaio inossidabile
Aço inoxidável

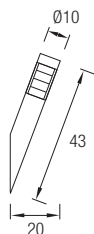

05-9239-Y4-M2

E-27 max. 60W

PL elect. E-27 max. 23W

IP 54 6

11W Included

PL 23W

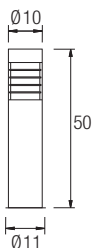
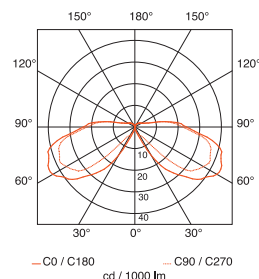

55-9239-Y4-M2

E-27 max. 60W

PL elect. E-27 max. 23W

IP 54 4 263

11W Included

PL 23W

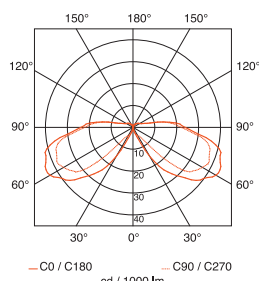

(new)

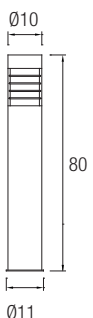

55-9440-Y4-M2

E-27 max. 60W

PL elect. E-27 max. 23W

IP 54 4 263

15W Included

PL 23W

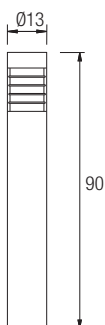
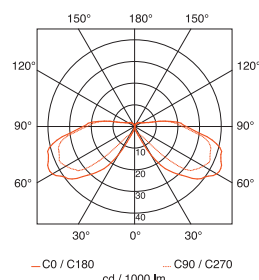

55-9317-Y4-M2

E-27 max. 100W

PL elect. E-27 max. 23W

IP 54 2

18W Included

PL 23W

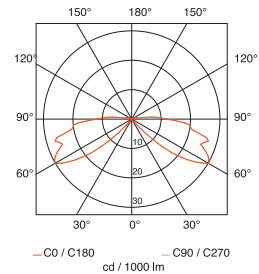

MUY IMPORTANTE consulte la tabla de usos y mantenimiento en la página 274
VERY IMPORTANT please consult the table on use and maintenance on page 274
TRÈS IMPORTANT consultez la table d'utilisation et de maintenance de la page 274

WICHTIG Bitte beachten Sie die Tabelle der Gebrauchs- und Instandhaltungsanweisungen auf Seite 274
MOLTO IMPORTANTE si consulti la tabella di uso e manutenzione a pagina 274
MUITO IMPORTANTE consulte a tabela de uso e manutenção na página 274

NEREO



Materiales / Materials



Especificaciones / Specifications



Acabados / Finishes

- Y4 Acero inoxidable
- Stainless steel
- Acier inoxydable
- Rostfreier Stahl
- Acciaio inossidabile
- Aço inoxidável

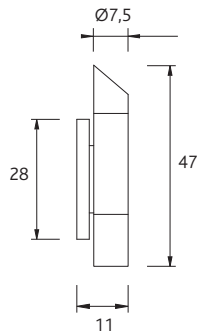

05-8796-Y4-M1

PL elect. E-27 20W - GE

IP 44 4

HERMES

Materiales / Materials



Especificaciones / Specifications



Acabados / Finishes

-  Y4 Acero inoxidable
- Stainless steel
- Acier inoxydable
- Rostfreier Stahl
- Acciaio inossidabile
- Aço inoxidável

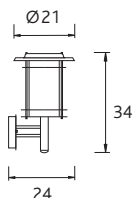

05-8788-Y4-M3 

 E-27 max. 60W

 PL elect. E-27 max. 23W

IP 23   4 



MUY IMPORTANTE consulte la tabla de usos y mantenimiento en la página 274
VERY IMPORTANT please consult the table on use and maintenance on page 274
TRÈS IMPORTANT consultez la table d'utilisation et de maintenance de la page 274

WICHTIG Bitte beachten Sie die Tabelle der Gebrauchs- und Instandhaltungsanweisungen auf Seite 274
MOLTO IMPORTANTE si consulti la tabella di uso e manutenzione a pagina 274
MUITO IMPORTANTE consulte a tabela de uso e manutenção na página 274

PEGASO

Materiales / Materials



Especificaciones / Specifications



Acabados / Finishes

 Y4 Acero inoxidable
Stainless steel
Acier inoxydable
Rostfreier Stahl
Acciaio inossidabile
Aço inoxidável



15-8797-Y4-F9 

 E-27 ø45 max. 60W

IP 23   4

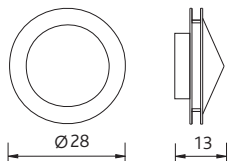

MUY IMPORTANTE consulte la tabla de usos y mantenimiento en la página 274
VERY IMPORTANT please consult the table on use and maintenance on page 274
TRÈS IMPORTANT consultez la table d'utilisation et de maintenance de la page 274

WICHTIG Bitte beachten Sie die Tabelle der Gebrauchs- und Instandhaltungsanweisungen auf Seite 274
MOLTO IMPORTANTE si consulti la tabella di uso e manutenzione a pagina 274
MUITO IMPORTANTE consulte a tabela de uso e manutenção na página 274

ARMONIA

Materiales / Materials



Especificaciones / Specifications



Acabados / Finishes

- Y4 Acero inoxidable
- Stainless steel
- Acier inoxydable
- Rostfreier Stahl
- Acciaio inossidabile
- Aço inoxidável



- 2 Frontales incluidos.
- 2 front covers included.
- 2 couvercles compris.
- 2 Frontteile inklusive.
- 2 frontali inclusi.
- 2 frontais incluídos.

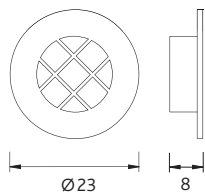

05-9121-Y4-B8 ■

 E-27 max 60W

 PL elect. E-27 15W - GE

IP 45   4 

ARIADNA

Ariadna 150

Materiales / Materials



Especificaciones / Specifications



Acabados / Finishes

- Z5 Gris urbano
- Urban grey
- Gris urbain
- Stadtgrau
- Grigio urbano
- Cinzeno urbano

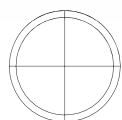

Ø26

10



15-9153-Z5-B8 ■

 E-27 max. 100W

 PL elect. E-27 max. 23W

IP 54   4 

 **23W Included**

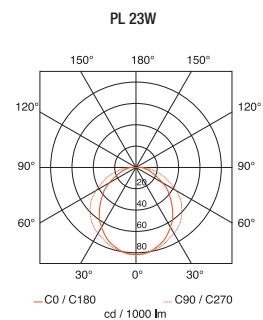

Materiales / Materials



Especificaciones / Specifications



Acabados / Finishes

-  Z5 Gris urbano
Urban grey
Gris urbain
Stadtgrau
Grigio urbano
Cinzeno urbano

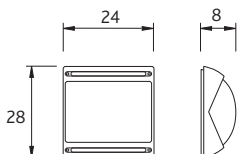

15-9119-Z5-M3 ■

2 x G24d-3 max. 26W Fluorescent

IP 23   4 

 **Included**

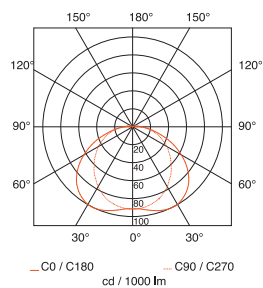

Materiales / Materials



Especificaciones / Specifications

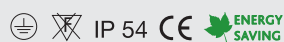

Acabados / Finishes

- Z5 Gris urbano
Urban grey
Gris urbain
Stadtgrau
Grigio urbano
Cinzeno urbano



15-9114-Z5-B8 ■

 2 x E-27 max 100W

 2 x PL elect. E-27 max. 23W

IP 54   2 

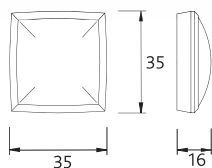
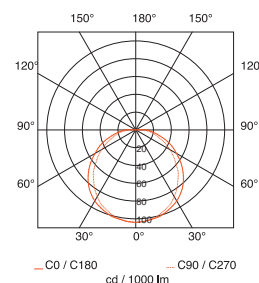

MIMER

Materiales / Materials



Especificaciones / Specifications

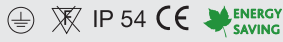

Acabados / Finishes

-  Z5 Gris urbano
Urban grey
Gris urbain
Stadtgrau
Grigio urbano
Cinzeno urbano

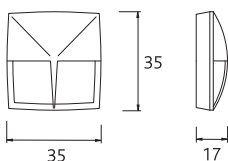

05-9114-Z5-B8 ■ (S)

 2 x E-27 max 100W

 2 x PL elect. E-27 max. 23W

IP 54   2 

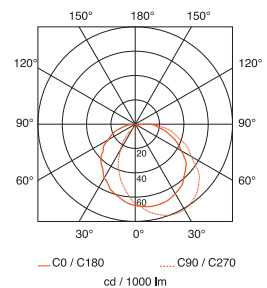

IRENE

154
Irene / Ares

Materiales / Materials



Especificaciones / Specifications



Acabados / Finishes

-  18 Marrón óxido
Rusted/oxide brown
- Rouille
- Rostbraun
- Marrone ossido
- Marrom óxido

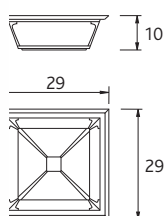

15-9209-18-M3

 2 x E-27 max 60W

 2 x PL elect. E-27 max. 18W

IP 44   6 

 2 x 18W **Included**

ARES

Materiales / Materials



Especificaciones / Specifications



Acabados / Finishes

-  18 Marrón óxido
Rusted/oxide brown
- Rouille
- Rostbraun
- Marrone ossido
- Marrom óxido

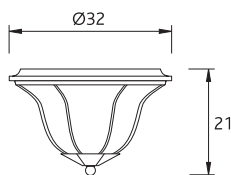

15-9102-18-B8

 2 X E-27 ø45 max. 60W

IP 23   4

PERGOLA®

Materiales / Materials



Especificaciones / Specifications



Acabados / Finishes

-  92 Madera de teka
- Teka wood
- Bois de teck
- Teakholz
- Legno di teak
- Madeira de teka

155

Pergola



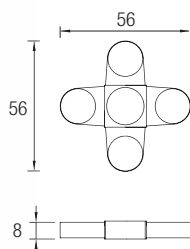

Incluye un sistema fácil y exclusivo para colgar en pérgolas.
 Includes an exclusive and easy system for hanging in pergolas.
 Inclut un système pratique et exclusif pour suspendre dans les terrasses.
 Schließt ein einfaches System ausschließlich zum Aufhängen an Pergolen.
 Include sistema facile e esclusivo per collegare in gazebo.
 Inclui um sistema fácil e exclusivo para pendurar em pérgolas.





15-9340-92-B8  (S)

 4 x E-27 \varnothing 45 max. 60W

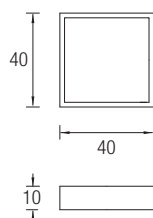

 4 x PL elect. E-27 max. 21W

 IP 23  



15-9341-92-M2  (S)

 4 x PL elect. E-27 max. 23W

 IP 23  



SELENE

156

Selene

Selene COLLECTION

- Serie realizada en aluminio inyectado pensada para su uso como applique y plafón. La serie presenta modelos con versiones Up & Down light. Asimismo, algunos modelos incluyen difusores extra de PMMA azul y amarillo.
- A collection made of die-cast aluminium, designed to be used as a wall fixture and a ceiling fixture. The collection has models with Up & Down light versions. Some models also include additional blue and yellow PMMA diffusers.
- Une série en aluminium injecté conçue pour une utilisation applique et plafond. La série présente des modèles avec versions Up & Down light. Certains modèles sont équipés de diffuseurs extra PMMA bleu et jaune.
- Die Produktserie ist aus gespritztem Aluminium hergestellt und für die Benutzung als Wand- und Deckenleuchte gedacht. Die Serie beinhaltet Modelle mit der Version für Up & Down Light - Schaltung. Außerdem schließt sie einige Modelle an Extra-Diffusoren mit PMMA blau und gelb ein.
- Serie realizzata in alluminio iniettato pensata per l'uso come applique e plafoniera. La serie presenta modelli con versioni Up&Down light. Inoltre, alcuni modelli comprendono diffusori supplementari di PMMA di colore azzurro e giallo.
- Série feita em alumínio injectado pensada para ser usada como applique e lustre. A série apresenta modelos com versões Up & Down light. De igual modo, alguns modelos incluem difusores extra de PMMA azul e amarelo.



Materiales / Materials



Especificaciones / Specifications

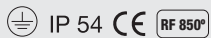

Acabados / Finishes

18 Marrón óxido Rusted/oxide brown	34 Gris Grey
Rouille Rostbraun	Gris Grau
Marrone ossido Marrom óxido	Grigio Cinzeno

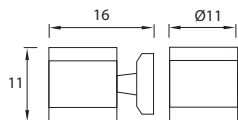

05-9309-34-37 ■

G9 max. 60W

IP 54 12

40W OSRAM **Included**

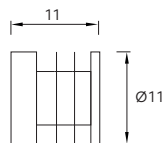
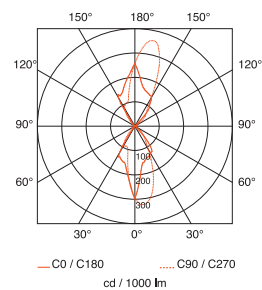

05-9308-18-B8 ■

05-9308-34-B8 ■

G9 max. 40W

IP 54 12

40W OSRAM **Included**





Materiales / Materials



Difusor de PMMA azul de cortesia para acabado 34 / Difusor de PMMA amarillo de cortesia para acabado 18.
Blue PMMA diffuser included for finish 34 / Yellow PMMA diffuser included for finish 18

Especificaciones / Specifications



Acabados / Finishes

18 Marrón óxido Rusted/oxide brown Rouille Rostbraun Marrone ossido Marrom óxido	34 Gris Grey Gris Grau Grigio Cinzeno
---	--

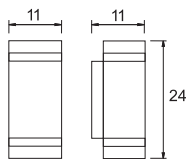

05-9234-18-37 ■
05-9234-34-37 ■

- 2 x GU-10 max. 50W
- 2 x GU-10 max. 11W Fluorescent
- 2 x GU-10 max. 5W LED



2 x OSRAM 50W **Included**

GU-10 50W

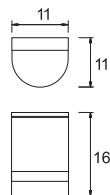
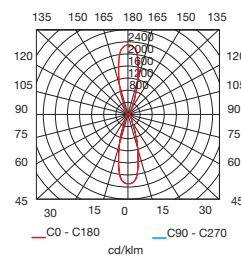

05-9235-18-37 ■
05-9235-34-37 ■

- GU-10 max. 50W
- GU-10 max. 11W Fluorescent
- GU-10 max. 5W LED



OSRAM 50W **Included**

GU-10 50W

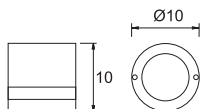
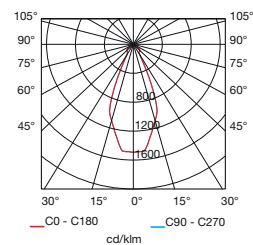

15-9234-18-37 ■
15-9234-34-37 ■

- GU-10 max. 50W
- GU-10 max. 11W Fluorescent
- GU-10 max. 5W LED



OSRAM 35W **Included**

GU-10 50W

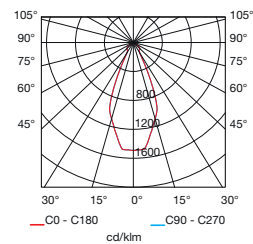

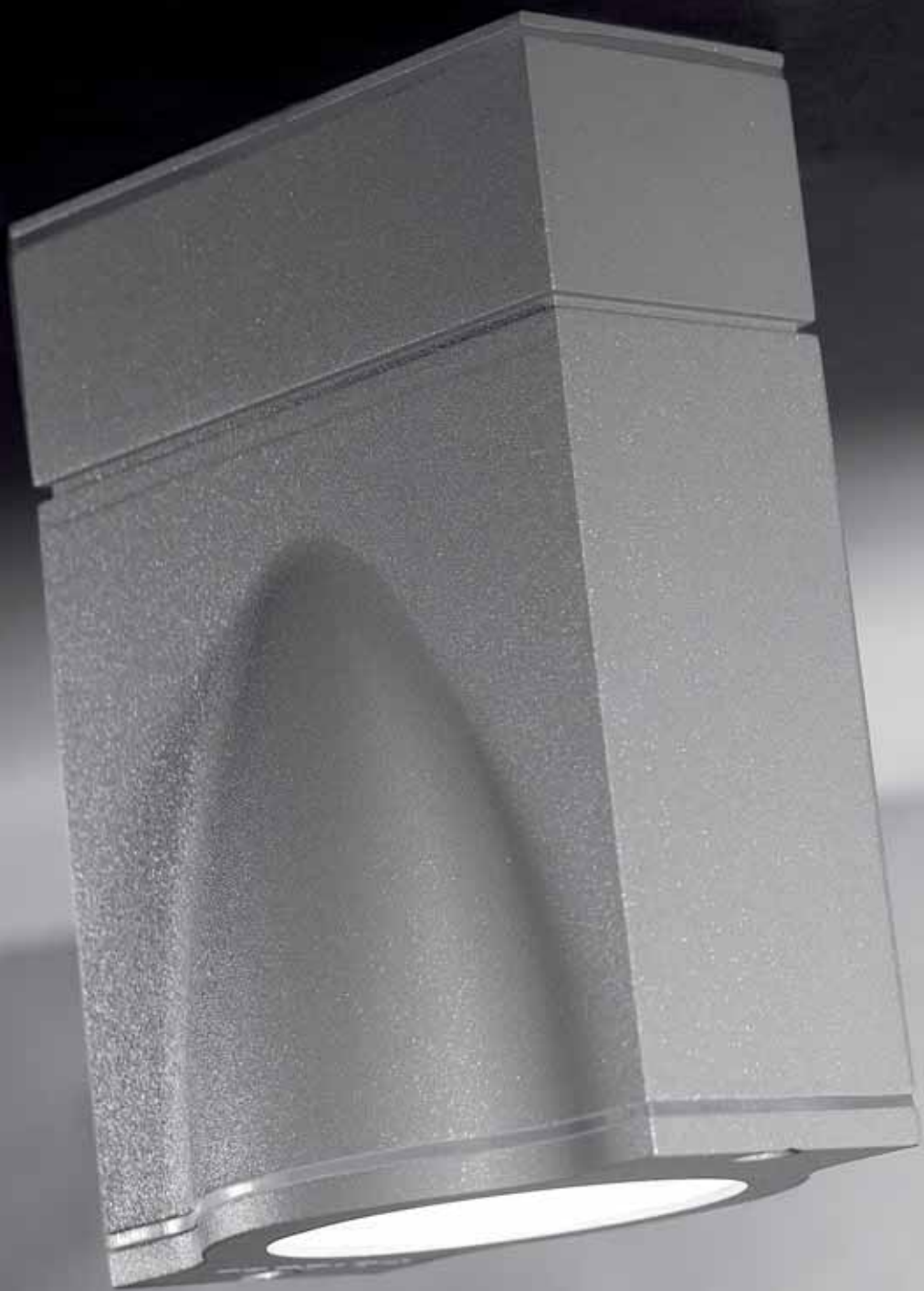

Soft COLLECTION [®]

- Colección realizada en cuerpo de inyección de aluminio con difusor de cristal satinado. La serie incluye un plafón, una baliza y dos apliques, uno de ellos en versión Up & Down Light. La baliza se presenta en versión doble orientable 120°.
- A collection with a die-cast aluminium body and a transparent satin glass diffuser. The series includes a ceiling fixture, a beacon and two wall fixtures, one of them in the Up & Down Light version. The beacon is available in a double 120° adjustable version.
- Collection réalisée en injection d'aluminium avec diffuseur en verre transparent. La série comprend un plafonnier, une balise et deux appliques dont l'une en version Up & Downlight. La balise est présentée en version double orientable à 120°.
- Bei dieser Kollektion ist der Körper der Leuchten aus Aluminiuminjektion hergestellt und die Modelle sind mit einem Lichtverteiler aus transparentem Glasdiffusor. Diese Serie schließt eine Deckenleuchte, ein Signallicht und zwei Wandleuchten ein, davon eine in der Version Up & Down Light. Das Signallicht wird in Doppelversion angeboten und kann im Winkel von 120° ausgerichtet werden.
- Collezione realizzata con corpo in alluminio iniettato e diffusore in cristallo satinato. La serie include una plafoniera, un faretto e due applique, una di esse in versione Up&Down Light. Il faretto è previsto in doppia versione orientabile a 120°.
- Coleção feita em corpo de injeção de alumínio com difusor de vidro satinado. A série inclui um lustre, um foco luminoso e dois apliques, um deles na versão Up & Down Light. O foco luminoso apresenta-se em versão dupla orientável em 120°.

[®] Registration number: 001091375-027 / 001091375-028 / 001091375-029





Materiales / Materials



Especificaciones / Specifications



Acabados / Finishes

- 34 Gris
- Grey
- Gris
- Grau
- Grigio
- Cinzento

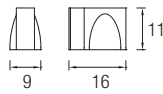

05-9370-34-T2 ■

- ▶ GU-10 max. 50W
- ▶ GU-10 max. 11W Fluorescent
- ▶ GU-10 max. 5W LED

IP 54 6 IK 07

▶ OSRAM 50W **Included**

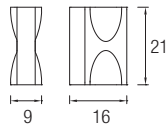
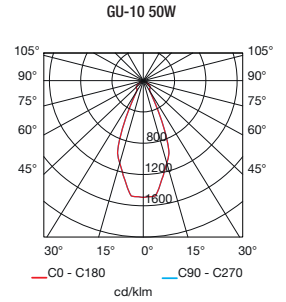

05-9371-34-T2 ■

- ▶ 2 x GU-10 max. 50W
- ▶ 2 x GU-10 max. 11W Fluorescent
- ▶ 2 x GU-10 max. 5W LED

IP 54 4 IK 07

▶ 2 x OSRAM 50W **Included**

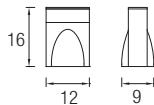
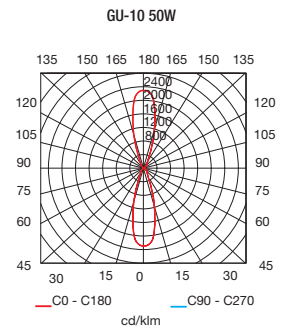

15-9370-34-T2 ■ (S)

- ▶ GU-10 max. 50W
- ▶ GU-10 max. 11W Fluorescent
- ▶ GU-10 max. 5W LED

IP 54 6 IK 07

▶ OSRAM 50W **Included**

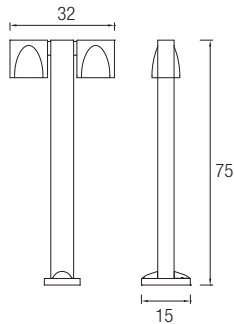
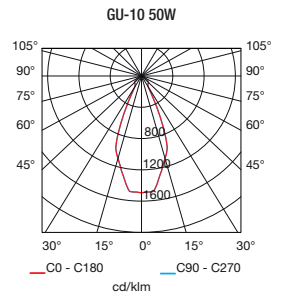

55-9371-34-T2 ■ (S)

- ▶ 2 x GU-10 max. 50W
- ▶ 2 x GU-10 max. 11W Fluorescent
- ▶ 2 x GU-10 max. 5W LED

IP 44 2 265 IK 07

▶ 2 x OSRAM 50W **Included**

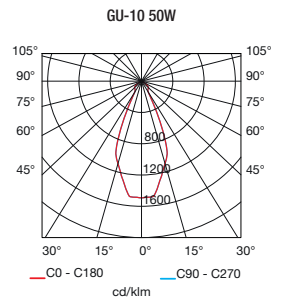



ICARO COLLECTION

- La serie ICARO dispone de una amplia variedad de opciones desde el foco, hasta la baliza pasando por el "pincho", incluyendo el doble foco. Todas las opciones se pueden orientar para satisfacer cualquier necesidad de iluminación.
- The ICARO collection comes with a wide variety of options – the spotlight, the beacon, the support, including the double spotlight. All the options can be turned round to satisfy any lighting requirements.
- La Série ICARO offre un large choix d'options: du faisceau à la balise en passant par les "pieux" et le double faisceau. Les différentes options permettent de répondre à tous les besoins d'illumination.
- Die ICARO Produktserie verfügt über eine große Auswahl, die Scheinwerfer und Leuchtbaken bis hin zur "Stecklampe" sowie Doppelscheinwerfers einschließt. Alle Optionen sind verstellbar, sodass jedem Bedarf an Beleuchtung nachgekommen werden kann.
- La serie ICARO dispone di un'ampia varietà di opzioni, dal riflettore al faretto, comprendendo il riflettore doppio. Tutte le opzioni si possono orientare per soddisfare qualsiasi necessità di illuminazione.
- A série ICARO dispõe de uma grande variedade de opções desde o foco, até à sinalização passando pelo "pico", incluindo o duplo foco. Todas as opções podem ser orientadas para a satisfação de qualquer necessidade de iluminação.



Materiales / Materials



Especificaciones / Specifications

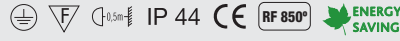

Acabados / Finishes

- 34 Gris
- Grey
- Gris
- Grau
- Grigio
- Cinzento

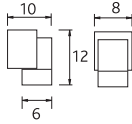
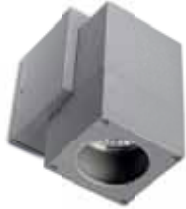

05-9190-34-37 ■

- ▶ GU-10 max. 50W
- ▶ GU-10 max. 11W Fluorescent
- ▶ GU-10 max. 5W LED

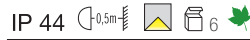

▶ OSRAM 50W **Included**

GU-10 50W

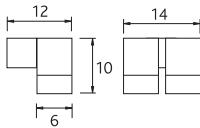
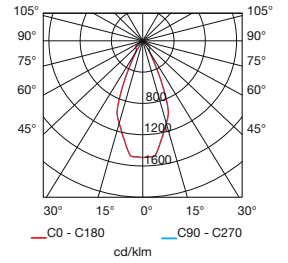

05-9191-34-37 ■

- ▶ 2 x GU-10 max. 50W
- ▶ 2 x GU-10 max. 11W Fluorescent
- ▶ 2 x GU-10 max. 5W LED



▶ 2 x OSRAM 50W **Included**



GU-10 50W

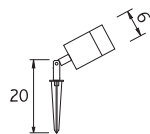
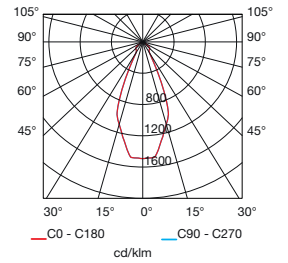

55-9191-34-37 ■

- ▶ GU-10 max. 50W
- ▶ GU-10 max. 11W Fluorescent
- ▶ GU-10 max. 5W LED



▶ OSRAM 50W + 2.5m **Included**



GU-10 50W

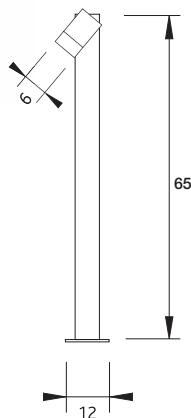
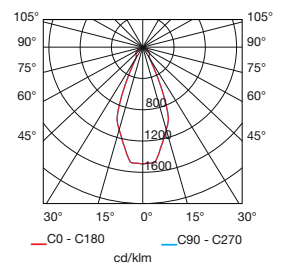

55-9190-34-37 ■

- ▶ 2 x GU-10 max. 50W
- ▶ 2 x GU-10 max. 11W Fluorescent
- ▶ 2 x GU-10 max. 5W LED



▶ 2 x OSRAM 50W **Included**

GU-10 50W

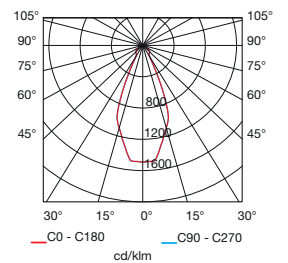



ALEXANDRIA

167

Alexandria

Alexandria COLLECTION

- La Serie Alexandria añade a su amplia oferta de balizas y apliques dos acabados diferentes, siendo apta para uso con lámparas de bajo consumo.
- The Alexandria collection adds two different finishes to its wide range of beacons and wall fixtures. It is suitable for the use of energy-saving lamps.
- La Série Alexandria ajoute à sa vaste collection de balises et appliques deux nouvelles finitions compatibles avec l'utilisation de lampes basse consommation.
- Die Produktsérie Alexandria schließt in das umfangreiche Angebot von Leuchtbaken und Wandleuchten zwei weitere Ausführungen ein, die sich für den Gebrauch von Energiesparlampen eignen.
- La Serie Alexandria aggiunge alla sua ampia offerta di faretti e applique due finiture differenti, essendo adatta all'uso con lampade a basso consumo.
- A Série Alexandria acrescenta à sua ampla oferta de sinalizações e apliques dois acabamentos diferentes, estando preparada para ser usada com lâmpadas de baixo consumo.





Materiales / Materials



Especificaciones / Specifications



Acabados / Finishes

■ 18 Marrón óxido Rusted/oxide brown Rouille Rostbraun Marrone ossido Marrom óxido	■ 34 Gris Grey Gris Grau Grigio Cinzeno
---	--

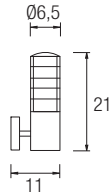

■ **05-9195-18-T2** ■
■ **05-9195-34-T2** ■

⚡ E-27 100W-HAL

💡 PL elect. E-27 20W-GE

IP 44 ⚡ 6 🌿

🔌 11W **Included**

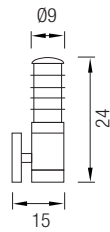

■ **05-9329-18-B8** ■
■ **05-9329-34-B8** ■

💡 E-27 max. 100W

💡 PL elect. E-27 max. 23W

IP 44 ⚡ 6 🌿

🔌 18W **Included**

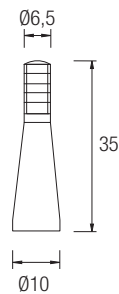

■ **10-9195-18-T2** ■
■ **10-9195-34-T2** ■

⚡ E-27 100W-HAL

💡 PL elect. E-27 20W-GE

IP 44 ⚡ 4 🌿 261

🔌 11W **Included**



Materiales / Materials





Especificaciones / Specifications

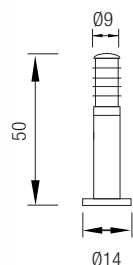

Acabados / Finishes

■ 18 Marrón óxido Rusted/oxide brown Rouille Rostbraun Marrone ossido Marrom óxido	■ 34 Gris Grey Gris Grau Grigio Cinzento
---	---





10-9329-18-B8 ■
10-9329-34-B8 ■

 E-27 max. 100W

 PL elect. E-27 max. 23W

IP 44   4  262 

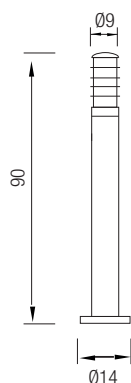
 18W **Included**





55-9329-18-B8 ■
55-9329-34-B8 ■

 E-27 max. 100W

 PL elect. E-27 max. 23W

IP 44   4  262 

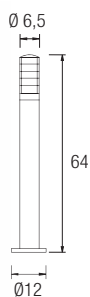
 18W **Included**



55-9195-18-T2 ■
55-9195-34-T2 ■

 E-27 100W-HAL

 PL elect. E-27 20W-GE

IP 44   4  263 

 11W **Included**

HEBE



172

Hebe

Hebe COLLECTION

- De diseño moderno, se adapta a cualquier ambiente. Fabricada en aluminio inyectado y difusor de policarbonato mate.
- A modern design that adapts to any kind of environment. Made of die-cast aluminium and a matt-finish polycarbonate diffuser.
- Un design moderne qui s'adapte à tout les espaces. Une série fabriquée en aluminium injecté avec diffuseur en polycarbonate mat.
- Von modernem Design, das sich an jedes Ambiente anpasst, hergestellt aus gespritztem Aluminium und mit Diffusor aus mattem Polykarbonat.
- Dal design moderno, si adatta a qualsiasi ambiente. In alluminio iniettato e diffusore in policarbonato opaco.
- De concepção moderna, adapta-se a qualquer ambiente. Fabricada em alumínio injectado e difusor de policarbonato mate.



Características / Specifications



Especificaciones / Specifications

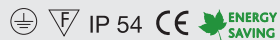

Acabados / Finishes

- 34 Gris
- Grey
- Gris
- Grau
- Grigio
- Cinzeno

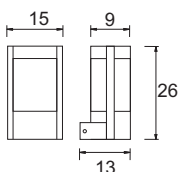

05-9238-34-M3 ■

- E-27 max. 100W
- ⚡ PL elect. E-27 Max. 30W
- IP 54 6
- ▶▶ 18W **Included**

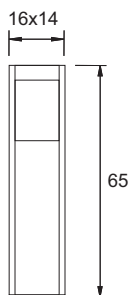
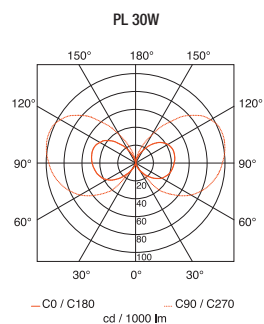

55-9238-34-M3 ■

- E-27 max. 100W
- ⚡ PL elect. E-27 Max. 30W
- IP 54 4 263
- ▶▶ 18W **Included**

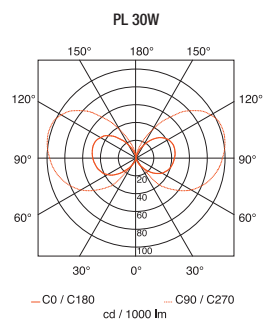



IXION COLLECTION [®]

- La madera de Teca de la serie Ixion se une a los detalles de acero inox. AISI 304 para hacerla adecuada para los ambientes más nobles.
- Ixion includes teak wood together with stainless steel details. AISI 304 to make it suitable for the noblest environments.
- Le bois de teck de la série Ixion allié à l'acier inoxydable AISI 304 nous offre une série qui s'adapte parfaitement aux espaces les plus nobles.
- Das Tekaholz der Produktserie Ixion ist mit Details aus rostfreiem AISI 304 Stahl verbunden worden, damit es sich an ein eleganteres Ambiente anpasst.
- Il legno di Tek della serie Ixion si unisce ai dettagli in acciaio inossidabile AISI 304 per un connubio adeguato agli ambienti più nobili.
- A madeira de Teca da série Ixion junta-se aos detalhes de aço inox AISI 304 para se tornar indicada para os ambientes mais nobres.

[®] Registration number: 000504063-0011 / 000504063-0013



Materiales / Materials



Especificaciones / Specifications



Acabados / Finishes

- 92 Madera de teka
- Teka wood
- Bois de teck
- Teakholz
- Legno di teak
- Madeira de teka

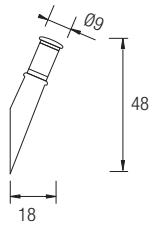

05-9176-92-B8 ■

○ E-27 max. 100W

⏏ PL elect. E-27 max. 23W

IP 44 ☒ 4 🍃

▶▶ 18W **Included**

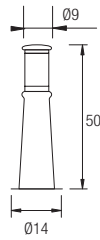

10-9176-92-B8 ■

○ E-27 max. 100W

⏏ PL elect. E-27 max. 23W

IP 44 ☒ 4 🍃 261

▶▶ 18W **Included**

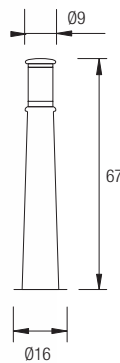

55-9176-92-B8 ■

○ E-27 max. 100W

⏏ PL elect. E-27 max. 23W

IP 44 ☒ 2 🍃 261

▶▶ 18W **Included**



Mark COLLECTION [®]

- El estilo de la serie Mark la hace idónea tanto para ambientes modernos como clásicos, disponiendo de una amplia oferta de soluciones.
- The style of the Mark collection makes it ideal for both modern and traditional environments, and it offers a wide range of solutions.
- Le style de la série Mark est idéal tant pour les espaces modernes que classiques et dispose d'une vaste gamme de solutions.
- Der Stil von der Produktserie Mark eignet sich sowohl für modernes als auch klassisches Ambiente und sie verfügt außerdem über umfangreiche Lösungen.
- Per il suo stile, la serie Mark è adatta tanto agli ambienti moderni quanto a quelli classici, disponendo di un'ampia offerta di soluzioni.
- O estilo da série Mark torna-se idónea para ambientes tanto modernos como clássicos, e dispõe de uma ampla oferta de soluções.

[®] Registration number: 000835277-0034 / 000835277-028 / 000835277-0029





Materiales / Materials



Especificaciones / Specifications



Acabados / Finishes

- Z5 Gris urbano
- Urban grey
- Gris urbain
- Stadtgrau
- Grigio urbano
- Cinzeno urbano

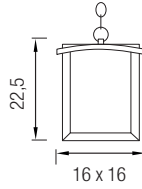

00-9298-Z5-M3 ■

⦿ E-27 max. 100W

💡 PL elect. E-27 max.18W

IP 23 ☒ 📦 6 🌿

🔊 13W **Included**

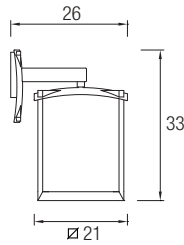

05-9390-Z5-M3 ■

⦿ E-27 max. 100W

💡 PL elect. E-27 max. 30W

IP 23 ☒ 📦 4 🌿

🔊 18W **Included**

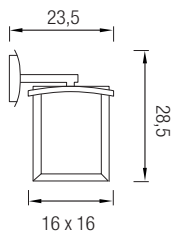
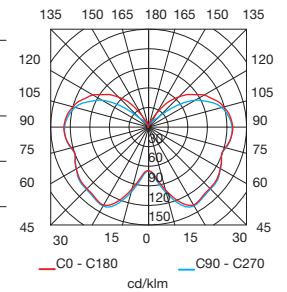

05-9298-Z5-M3 ■

⦿ E-27 max. 100W

💡 PL elect. E-27 max.18W

IP 23 ☒ 📦 6 🌿

🔊 13W **Included**

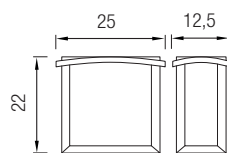

05-9299-Z5-M3 ■

⦿ 2 x E-27 max. 60W

💡 2 x PL elect. E-27 max.18W

IP 23 ☒ 📦 6 🌿

🔊 2 x 13W **Included**



Materiales / Materials



Especificaciones / Specifications



Acabados / Finishes

- Z5 Gris urbano
- Urban grey
- Gris urbain
- Stadtgrau
- Grigio urbano
- Cinzeno urbano

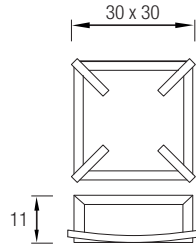

15-9298-Z5-M3 ■

○ 2 x E-27 max. 60W

▬ 2 x PL elect. E-27 max.23W

IP 44 ☒ 6 🌿

▬ 2 x 13W **Included**

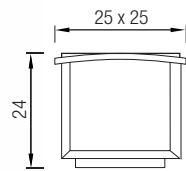

10-9299-Z5-M3 ■

○ E-27 max. 100W

▬ PL elect. E-27 max.23W

IP 44 ☒ 4 🌿 261

▬ 18W **Included**

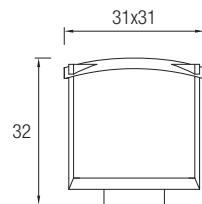
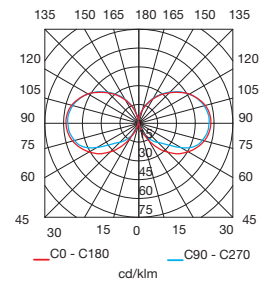

10-9390-Z5-M3 ■

○ E-27 max. 150W

▬ PL elect. E-27 max. 30W

IP 44 ☒ 2 🌿 262

▬ 23W **Included**

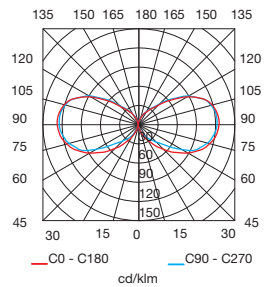



Materiales / Materials



Especificaciones / Specifications



Acabados / Finishes

- Z5 Gris urbano
- Urban grey
- Gris urbain
- Stadtgrau
- Grigio urbano
- Cinzeno urbano

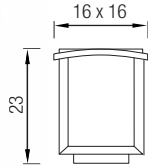

10-9298-Z5-M3 ■

⦿ E-27 max. 100W

⦿ PL elect. E-27 max. 18W

IP 44 ⚡ 6 🍴 261 🌿

⦿ 13W **Included**

IP+

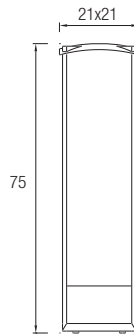

55-9390-Z5-M3 ■

⦿ 2G11 55W

IP 44 ⚡ 2 🍴 265 🌿

⦿ 55W + ⦿ **Included**

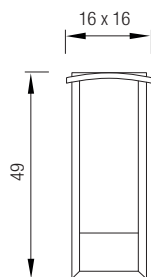
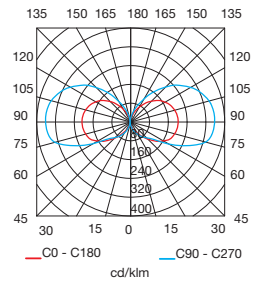

55-9298-Z5-M3 ■

⦿ 2G11 24W

IP 44 ⚡ 4 🍴 264 🌿

⦿ 24W + ⦿ **Included**



Janna COLLECTION

- Colección de estilo rústico con un diseño actual, formada por applique, colgante y sobremuro en acabado marrón óxido. Realizada en aluminio de alta calidad y con difusor de policarbonato. Se presenta con lámparas de bajo consumo incluidas.
- Collection in a rustic style with a current design, made up of a fitting, a pendant section and a lantern, with rust brown finish. Produced in high quality aluminium with polycarbonate diffuser. Supplied with low energy lights included.
- Collection de style rustique au design actuel, constituée par des appliques, des suspensions et des appliques murales avec une finition marron oxydé. Réalisée en aluminium de haute qualité et avec un diffuseur en polycarbonate. Elle est présentée avec des ampoules à économie d'énergie incluses.
- Kollektion in rustikalem Stil mit aktuellem Design. Sie besteht aus Wandlampe, Hängelampe und Mauerleuchte in antikbrauner Ausfertigung. Hergestellt aus hochwertigem Aluminium mit Diffusor aus Polycarbonat. Energiesparlampen werden migeliefert.
- Collezioni in stile rustico dal design attuale, formata da applique, sospensioni e paletti in finitura marrone ossido. Realizzata in alluminio di alta qualità e con diffusore in policarbonato. Fornita con lampadine a basso consumo incluse.
- Coleção de estilo rústico com um design actual, composta por applique, suspensão e applique de parede, com acabamento castanho oxidado. Concebida em alumínio de alta qualidade e com difusor em policarbonato. Fornecida com lâmpadas de baixo consumo incluídas.





Materiales / Materials



Especificaciones / Specifications



Acabados / Finishes

- 18 Marrón óxido
Rusted/oxide brown
- Rouille
- Rostbraun
- Marrone ossido
- Marron óxido

(new)

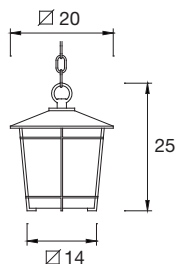

00-9447-18-M3 ■

○ E-27 max. 100W

⏏ PL elect. E-27 max.18W

IP 23 ☒ 4 🌿

⏏ 18W **Included**

IP+

(new)

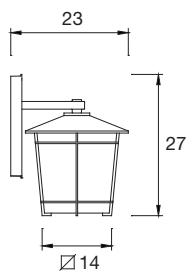

05-9447-18-M3 ■

○ E-27 max. 100W

⏏ PL elect. E-27 max.18W

IP 23 ☒ 4 🌿

⏏ 18W **Included**

IP+

(new)

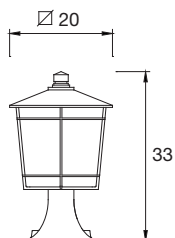

10-9447-18-M3 ■

○ E-27 max. 100W

⏏ PL elect. E-27 max.18W

IP 23 ☒ 4 🌿

⏏ 18W **Included**



Alba COLLECTION [®]

- De origen rústico, la serie Alba dispone de una amplia gama de soluciones con un diseño actual.
- The rustic-origin Alba collection includes a wide range of solutions, with a modern design.
- La Série Alba, aux origines rustiques, dispose d'une vaste gamme de solutions au design actuel.
- Die Serie Alba ist ländlichen Ursprungs. Sie verfügt über ein zeitgemäßes Design und bietet umfangreiche Lösungsmöglichkeiten.
- Di origine rustica, la serie Alba dispone di un'ampia gamma di soluzioni dal design attuale.
- De origem rústica, a série Alba dispõe de uma vasta gama de soluções com uma concepção actual.

[®] Registration number: 001091375-032 / 001091375-033 / 001091375-034





Materiales / Materials



Especificaciones / Specifications



Acabados / Finishes

- 18 Marrón óxido
Rusted/oxide brown
Rouille
Rostbraun
Marrone ossido
Marrom óxido

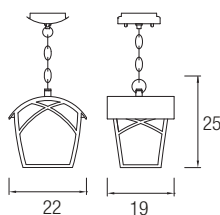

00-9350-18-AA ■

⦿ E-27 max. 100W

⦿ PL elect. E-27 max.18W

IP 23 ☒ 4 🍀

▶▶ 13W Included

IP+

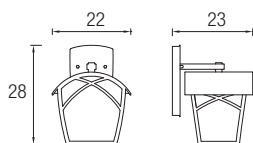

05-9350-18-AA ■

⦿ E-27 max. 100W

⦿ PL elect. E-27 max.18W

IP 23 ☒ 4 🍀

▶▶ 13W Included

IP+

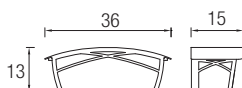

05-9351-18-AA ■

⦿ E-27 max. 100W

⦿ PL elect. E-27 max.18W

IP 23 ☒ 4 🍀

▶▶ 18W Included



Materiales / Materials



Especificaciones / Specifications



Acabados / Finishes

- 18 Marrón óxido
Rusted/oxide brown
- Rouille
Rostbraun
- Marrone ossido
Marrom óxido

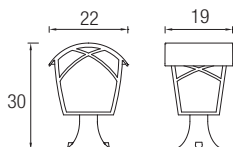

10-9350-18-AA ■

E-27 max. 100W

PL elect. E-27 max. 18W

IP 23 4

13W **Included**

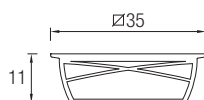

15-9350-18-AA ■

2 x E-27 max. 100W

2 x PL elect. E-27 max. 18W

IP 23 4

2 x 18W **Included**

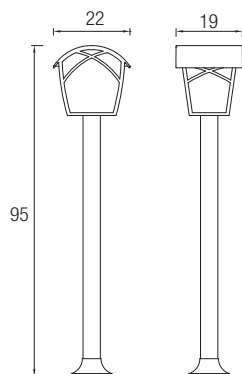

55-9350-18-AA ■

E-27 max. 100W

PL elect. E-27 max. 18W

IP 23 2

13W **Included**

CROSS



Cross COLLECTION ®

- Cross ofrece una gran amplitud de iluminación gracias a su gran difusor con un diseño actual que encaja en todos los ambientes.
- Cross offers a wide beam of light, thanks to its large modern-design diffuser which fits in any environment.
- Cross offre un grand choix d'illumination grâce à son diffuseur au design actuel qui s'adapte à tous les espaces.
- Cross verfügt über eine außerordentliche Leuchtkraft, dank des großen Diffusors von zeitgemäßem Design, der sich allen Ambien ten anpasst.
- Cross offre una grande ampiezza di illuminazione grazie al suo grande diffusore dal design attuale che si adatta in tutti gli ambienti.
- A Cross oferece uma iluminação muito ampla, graças ao seu grande difusor de concepção actual que se encaixa bem em todos os ambientes.

® Registration number: 000835277-0026



Materiales / Materials



Especificaciones / Specifications



Acabados / Finishes

- 18 Marrón óxido
Rusted/oxide brown
Rouille
Rostbraun
Marrone ossido
Marrom óxido

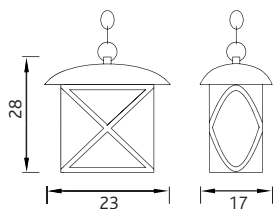

00-9295-18-M3 ■

E-27 max. 100W

PL elect. E-27 max. 18W

IP 23 6

13W Included

IP+

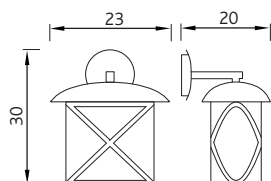

05-9295-18-M3 ■

E-27 max. 100W

PL elect. E-27 max. 18W

IP 23 6

13W Included

IP+

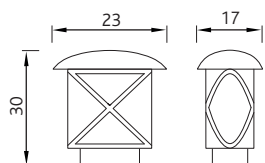

10-9295-18-M3 ■

E-27 max. 100W

PL elect. E-27 max. 18W

IP 44 6 261

13W Included

IP+

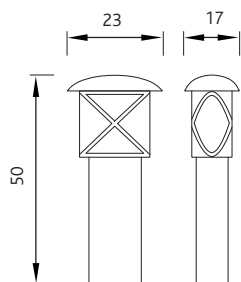

55-9295-18-M3 ■

E-27 max. 100W

PL elect. E-27 max. 18W

IP 44 4 261

13W Included

IP+

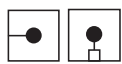

Reed COLLECTION

- Su amplitud de cristal proporciona una gran iluminación en cualquier ambiente.
- This collection includes large pieces of glass, which offers great lighting in any environment.
- La magnificence du verre offre une grande luminosité à toutes les ambiances.
- Die große Menge an Kristallglas verleiht dieser Serie eine außerordentliche Leuchtkraft in jedlichem Ambiente.
- L'ampiezza del cristallo permette di ottenere una vasta illuminazione in qualsiasi ambiente.
- A sua amplitude de vidro proporciona uma grande iluminação a qualquer ambiente.



Materiales / Materials



Especificaciones / Specifications



Acabados / Finishes

- 05 Negro
- Black
- Noir
- Schwarz
- Nero
- Preto

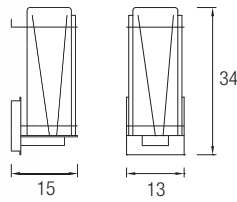

05-9356-05-B8 ■

E-27 max. 100W

PL elect. E-27 max.23W

IP 44

18W **Included**

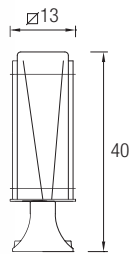

10-9356-05-B8 ■

E-27 max. 100W

PL elect. E-27 max.23W

IP 44

23W **Included**



Ciri COLLECTION

- Ofrece un estilo clásico aunque gracias a su diseño actual se hace apta a cualquier ambiente.
- A classical-style collection with a modern design that enables it to adapt to any environment.
- Un style classique qui, grâce à son design actuel, s'adapte à tous les espaces.
- Ein Produkt von klassischem Stil, das sich aber dank seines zeitgemäßen Design an jegliches Ambiente anpasst.
- Offre uno stile classico, per quanto grazie al suo design attuale si possa adattare a qualsiasi ambiente.
- Oferece um estilo clássico embora, graças à sua concepção actual, seja indicada para qualquer ambiente.



Materiales / Materials



Especificaciones / Specifications



Acabados / Finishes

- 05 Negro
- Black
- Noir
- Schwarz
- Nero
- Preto

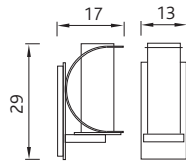

05-9330-05-B8 ■

E-27 max. 100W

PL elect. E-27 max. 18W

IP 44 6

13W **Included**

IP+

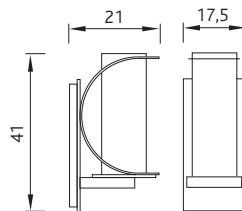

05-9331-05-B8 ■

E-27 max. 100W

PL elect. E-27 max. 23W

IP 44 4

18W **Included**

IP+

GRID



200

Grid

Grid COLLECTION

- En aluminio inyectado, la serie Grid se amplia con nuevas referencias adecuadas para uso en bajo consumo, y con difusor de cristal rústico.
- Grid, made of die-cast aluminium, is extended with new products and they are suitable for the use of energy-saving light, with a rustic glass diffuser.
- La série Grid, en aluminium injecté, s'agrandit., la série est compatible avec l'utilisation de lampes basse consommation, avec un diffuseur en verre rustique.
- Hergestellt aus Aluminium, ergänzt sie sich die Serie Grid. Die Serie eignet sich für den Gebrauch von Energiesparlampen und verfügt über einen Diffusor aus ungeschliffenem Kristallglas.
- In alluminio iniettato, Grid si amplia et è adeguata per l'uso in basso consumo, e con diffusore di cristallo rustico.
- Em alumínio injectado, a Grid é ampliada, sendo adequada para uso de baixo consumo, e com difusor de vidro rústico.



Materiales / Materials



Especificaciones / Specifications



Acabados / Finishes

- 18 Marrón óxido
Rusted/oxide brown
Rouille
Rostbraun
Marrone ossido
Marrom óxido

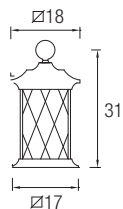

00-9389-18-AA ■

- E-27 max. 100W
- ⦿ PL elect. E-27 max.18W

IP 23 2

18W **Included**

IP+

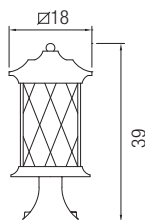

10-9389-18-AA ■

- E-27 max. 100W
- ⦿ PL elect. E-27 max.18W

IP 23 2

18W **Included**

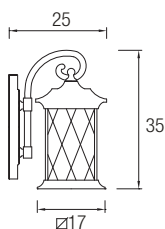

05-9389-18-AA ■

- E-27 max. 100W
- ⦿ PL elect. E-27 max.18W

IP 23 4

18W **Included**

IP+

Materiales / Materials



Especificaciones / Specifications



Acabados / Finishes

- 18 Marrón óxido
Rusted/oxide brown
- Rouille
- Rostbraun
- Marrone ossido
- Marrom óxido

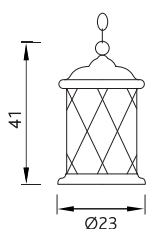

00-9312-18-AA ■

⦿ E-27 max. 100W

⦿ PL elect. E-27 max.23W

IP23 ⚡ 4 🍀

🔌 18W **Included**

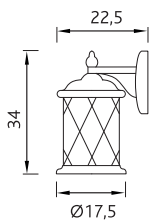

05-9312-18-AA ■

⦿ E-27 max. 60W

⦿ PL elect. E-27 max.18W

IP 23 ⚡ 6 🍀

🔌 13W **Included**

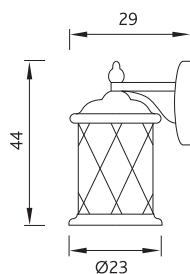

05-9313-18-AA ■

⦿ E-27 max. 100W

⦿ PL elect. E-27 max.23W

IP 23 ⚡ 4 🍀

🔌 18W **Included**



HERA

Materiales / Materials



Especificaciones / Specifications





Acabados / Finishes

-  18 Marrón óxido
- Rusted/oxide brown
- Rouille
- Rostbraun
- Marrone ossido
- Marron óxido

203

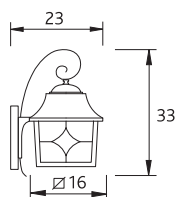
Hera



05-9124-18-37 

 E-27 max. 100W

 PL elect. E-27 max. 15W

IP 23   6 

CRIS + **Included**

ODISEO



204

Odiseo



Odiseo COLLECTION

- Fabricado en aluminio inyectado la colección Odiseo dispone de una amplia oferta incluyendo un cristal de recambio de cortesía.
- The Odiseo collection, made of die-cast aluminium, offers a wide range of lights, including a courtesy spare glass.
- Fabriqué en aluminium injecté, la collection Odisea dispose d'une vaste gamme tout en incluant un verre de rechange offert.
- Die Kollektion Odisea, hergestellt aus gespritztem Aluminium, verfügt über ein umfangreiches Angebot und sie schließt ein nicht angerechnetes Ersatzkristall ein.
- Fabbricata in alluminio iniettato, la collezione Odisea presenta un'ampia offerta, e include un cristallo di ricambio in omaggio.
- Fabricada em alumínio inyectado, a coleção Odiseia tem uma grande oferta, incluindo um vidro de substituição como oferta.



Materiales / Materials



Especificaciones / Specifications



Acabados / Finishes

- 18 Marrón óxido
- Rusted/oxide brown
- Rouille
- Rostbraun
- Marrone ossido
- Marrom óxido

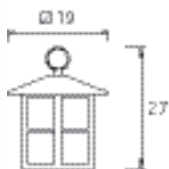

00-9126-18-AA ■

○ E-27 max. 100W

■ PL elect. E-27 max. 18W

IP 23 4

18W + Included

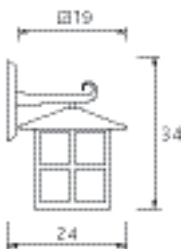

05-9126-18-AA ■

○ E-27 max. 100W

■ PL elect. E-27 max. 18W

IP 23 4

18W + Included

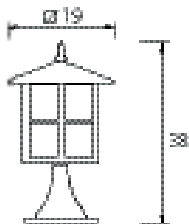

10-9126-18-AA ■

○ E-27 max. 100W

■ PL elect. E-27 max. 18W

IP 23 4

18W + Included

PERSEFONE

206

Persefone

Persefone COLLECTION

- Persefone emula las antiguas luces de aceite y gracias a su diseño se puede utilizar con lámparas de bajo consumo.
- Persefone emulates ancient oil lamps and thanks to its design it can be used with energy-saving lamps.
- La série Persefone nous rappelle les anciennes lampes à huile. Grâce à son design, elle peut être utilisée avec des lampes basse consommation.
- Persefone erinnert an die alten Öllampen; sie können dank ihres Design mit Energiesparlampen benutzt werden.
- Persefone imita le vecchie lampade a olio e grazie al suo design si può utilizzare con lampade a basso consumo.
- A Persefone imita as antigas luzes de óleo e, graças à sua concepção, pode ser utilizada com lâmpadas de baixo consumo.

 Registration number: 000504063-0010

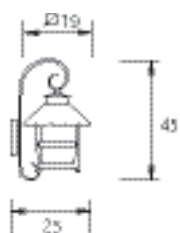

05-9202-18-AA 

 E-27 max. 100W /  PL elect. E-27 max. 23W

IP 23   4 

 18W +  **Included**

IP+

Materiales / Materials



Especificaciones / Specifications



Acabados / Finishes

- 18 Marrón óxido
Rusted/oxide brown
Rouille
Rostbraun
Marrone ossido
Marrom óxido

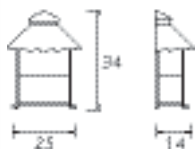

05-9261-18-AA ■

⦿ E-27 max. 100W / ⦿ PL elect. E-27 max.23W

IP 23 6

18W + Included

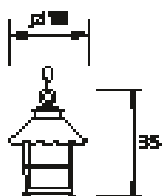

00-9202-18-AA ■

⦿ E-27 max. 100W / ⦿ PL elect. E-27 max.23W

IP 23 4

18W + Included



10-9202-18-AA ■

⦿ E-27 max. 100W / ⦿ PL elect. E-27 max.23W

IP 23 4

18W + Included

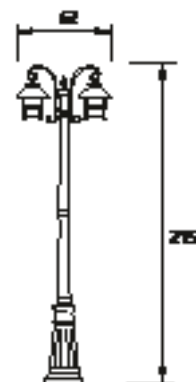

60-9203-18-AA ■

⦿ 2 x E-27 max. 100W / ⦿ 2 x PL elect. E-27 max.23W

IP23 2

2 x 18W + Included



55-9203-18-18 ■

Columna / Column



farola completa / complete lamp-post

60-9203-18-AA + 55-9203-18-18

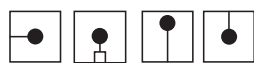

Edipo COLLECTION

- Edipo destaca por su combinación de líneas rectas y curvas con un diseño semi-rústico. Adicionalmente la colección dispone en todas sus variantes de un cristal de recambio de cortesía.
- Edipo stands out because of its combination of straight lines and curves, with a semi-rustic design. All the versions also come with a complimentary spare piece of glass.
- L'Edipo est mis en valeur grâce à ses lignes droites et courbes selon un design semi rustique. D'autre part, la collection dispose dans toutes ses variations d'un verre de rechange offert.
- Edipo hebt sich aufgrund der Kombinationen von geraden Linien und Kurven halbländlichen Designs hervor. Zusätzlich verfügen alle Modelle der Kollektion über ein nicht angerechnetes Ersatzkristall.
- Edipo si distingue per la sua combinazione di linee rette e curve in un design semi-rustico. Inoltre la collezione dispone in tutte le sue varianti di un cristallo di ricambio in omaggio.
- A Edipo destaca-se pela sua combinação de linhas rectas com curvas numa concepção semi-rústica. Adicionalmente, a colecção dispõe em todas as suas variantes de um vidro de substituição como oferta.



Materiales / Materials



Especificaciones / Specifications



Acabados / Finishes

- 18 Marrón óxido
Rusted/oxide brown
Rouille
Rostbraun
Marrone ossido
Marrom óxido

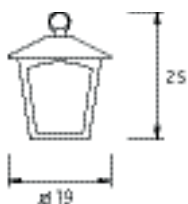

00-9149-18-AA ■

- E-27 max. 100W
- PL elect. E-27 15W - GE

IP 23

11W + Included

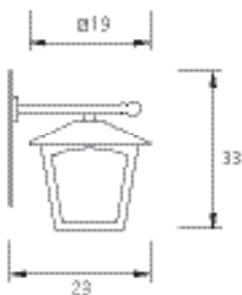

05-9149-18-AA ■

- E-27 max. 100W
- PL elect. E-27 15W - GE

IP 23

11W + Included

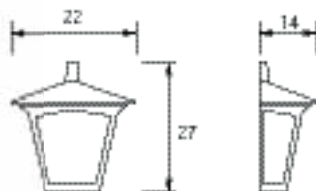

05-9180-18-AA ■

- E-27 max. 60W
- PL elect. E-27 15W - GE

IP 23

11W Included

Materiales / Materials



Especificaciones / Specifications



Acabados / Finishes

- 18 Marrón óxido
Rusted/oxide brown
- Rouille
- Rostbraun
- Marrone ossido
- Marrom óxido

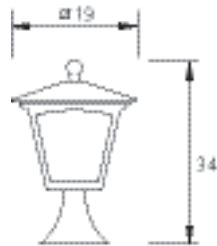
**10-9149-18-AA ■**

○ E-27 max. 100W

■ PL elect. E-27 15W - GE

IP 23 6

11W + **Included**

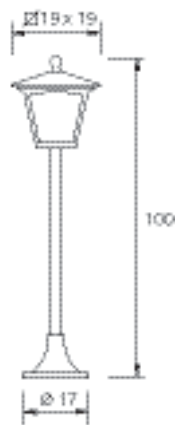
**55-9149-18-AA ■**

○ E-27 max. 100W

■ PL elect. E-27 15W - GE

IP 23 6

11W + **Included**

Materiales / Materials



Especificaciones / Specifications



Acabados / Finishes

- 18 Marrón óxido
Rusted/oxide brown
- Rouille
- Rostbraun
- Marrone ossido
- Marrom óxido

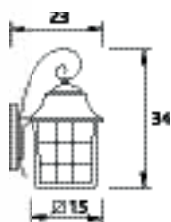

05-9150-18-AA ■

E-27 max. 100W

PL elect. E-27 20W - GE

IP 23 6

18W + **Included**

ITACA



212

Itaca



Itaca COLLECTION

- La serie Itaca está disponible en colgante, baliza y aplique estando fabricada en aluminio inyectado y difusor de cristal transparente.
- The Itaca collection is available as pendant, beacon and wall fixture. It is made of die-cast aluminium and a transparent glass diffuser.
- La Série Itaca est disponible en lustre, balise et applique. Elle est fabriquée en aluminium injecté et dispose d'un diffuseur en verre transparent.
- Die Produktserie Itaca ist als Hängelampe, Leuchtbake und Wandleuchte erhältlich und sie ist aus gespritztem Aluminium mit transparentem Kristalldiffusor gefertigt worden.
- La serie Itaca è disponibile in pensile, faretto e applique essendo fabbricata in alluminio iniettato, con diffusore di cristallo trasparente.
- A série Itaca está disponível para suspensão, sinalização e aplique, sendo fabricada com alumínio injetado e difusor de vidro transparente.



Materiales / Materials



Especificaciones / Specifications



Acabados / Finishes

- 18 Marrón óxido
Rusted/oxide brown
- Rouille
- Rostbraun
- Marrone ossido
- Marrom óxido

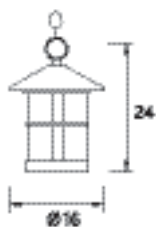

00-8958-18-37 ■ (S)

○ E-27 max. 60W

IP 23 6

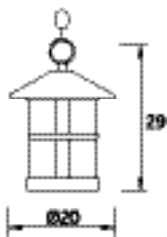

00-9132-18-AA ■

○ E-27 max. 100W

■ PL elect. E-27 max. 18W

IP 23 4

18W **Included**

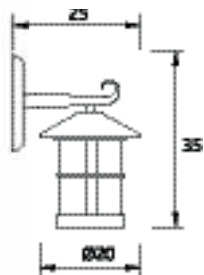

05-9132-18-AA ■

○ E-27 max. 100W

■ PL elect. E-27 max. 18W

IP 23 4

18W **Included**



Materiales / Materials



Especificaciones / Specifications



Acabados / Finishes

- 18 Marrón óxido
- Rusted/oxide brown
- Rouille
- Rostbraun
- Marrone ossido
- Marrom óxido



10-9132-18-AA ■

○ E-27 max. 100W

■ PL elect. E-27 max. 18W

IP 23 4

18W **Included**

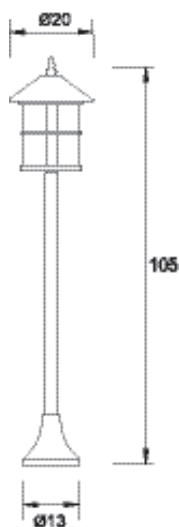

55-9132-18-AA ■

○ E-27 max. 100W

■ PL elect. E-27 max. 18W

IP 23 2

18W **Included**

Materiales / Materials





Especificaciones / Specifications

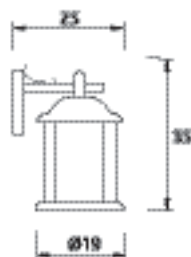

Acabados / Finishes

-  18 Marrón óxido
- Rusted/oxide brown
- Rouille
- Rostbraun
- Marrone ossido
- Marrom óxido



05-8940-18-37  (S)

 E-27 max. 100W

 PL elect. E-27 max.23W

IP23   6 

ANTEO



216

Anteo



Anteo COLLECTION

- La serie Anteo, fabricada en aluminio inyectado y con difusor de cristal de estilo rústico, evoca las antiguas luces de queroseno. Está disponible como applique, sobremuro y colgante.
- The Anteo collection, made of die-cast aluminium and a rustic-style diffuser, evokes old kerosene lamps. It is available as wall fixture, lantern and pendant.
- La Série Anteo, fabriquée en aluminium injecté avec un diffuseur en verre de style rustique qui évoque les anciennes lanternes au kérosène. Elle est disponible en applique, borne et lustre.
- Die Serie Anteo ist aus gespritztem Aluminium hergestellt, verfügt über einen Kristalldiffusoren von ländlichem Stil und erinnert an die alten Kerosinlampen. Sie ist als Wandleuchte, Hängelampe und Lampe für Außenwände erhältlich.
- La serie Anteo, fabbricata in alluminio iniettato e diffusore in cristallo di stile rustico, evoca le vecchie luci a cherosene. È disponibile come applique, elemento a muro e pensile.
- A série Anteo, fabricada em alumínio injectado e com difusor de vidro de estilo rústico



Materiales / Materials



Especificaciones / Specifications



Acabados / Finishes

- 18 Marrón óxido
- Rusted/oxide brown
- Rouille
- Rostbraun
- Marrone ossido
- Marrom óxido

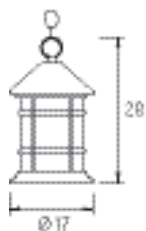

00-9100-18-37 ■ (S)

○ E-27 max. 100W

■ PL elect. E-27 max.20W

IP 23 4

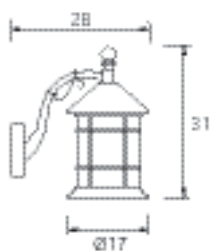

05-9100-18-37 ■

○ E-27 max. 100W

■ PL elect. E-27 max.20W

IP 23 4

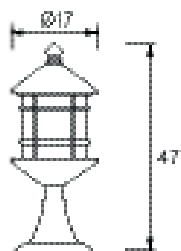

10-9100-18-37 ■ (S)

○ E-27 max. 100W

■ PL elect. E-27 max.20W

IP 23 4

MORFEO®

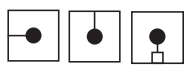

Materiales / Materials



Especificaciones / Specifications

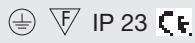

Acabados / Finishes

■ 18 Marrón óxido Rusted/oxide brown Rouille Rostbraun Marrone ossido Marrom óxido	■ 34 Gris Grey Gris Grau Grigio Cinzeno	■ J6 Marrón Bown Marron Braun Marrone Castanho
---	--	---



10-9432-34-B8 ■
10-9432-J6-B8 ■

⚡ E-14 max. 60W

IP 23 4

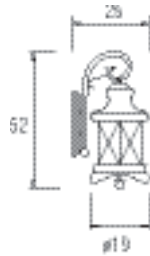

05-9175-18-AA ■

⚡ 3 x E-14 max. 60W

IP 23 4

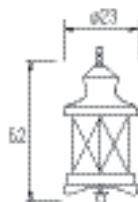

00-9175-18-AA ■

⚡ 3 x E-14 max. 60W

IP 23 2

POSIDO

Materiales / Materials



Especificaciones / Specifications



Acabados / Finishes

- 14 Blanco
- White
- Blanc
- Weiß
- Bianco
- Branco

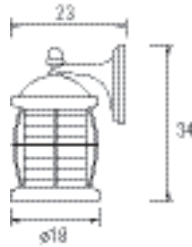

05-9258-14-B8 (S)

E-27 max. 60W

PL elect. E-27 max. 18W

IP 23 4

13W **Included**

HADES

Materiales / Materials



Especificaciones / Specifications



Acabados / Finishes

- 18 Marrón óxido
- Rusted/oxide brown
- Rouille
- Rostbraun
- Marrone ossido
- Marron óxido



05-8938-18-37

E-27 max. 100W

PL elect. E-27 max. 23W

IP 23 4

SIRENA

Materiales / Materials



Especificaciones / Specifications





Acabados / Finishes

-  18 Marrón óxido
- Rusted/oxide brown
- Rouille
- Rostbraun
- Marrone ossido
- Marrom óxido

221

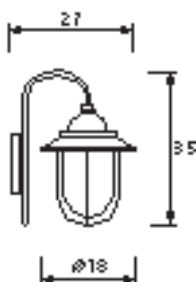
Sirena



05-9104-18-M2 

 E-27 max. 60W

 PL elect. E-27 max. 18W

IP 44   

Materiales / Materials





Especificaciones / Specifications

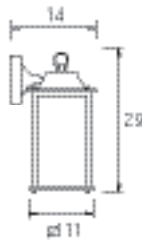

Acabados / Finishes

-  18 Marrón óxido
Rusted/oxide brown
- Rouille
- Rostbraun
- Marrone ossido
- Marrom óxido





05-8962-18-37  (S)

 E-27 max. 100W

 PL elect. E-27 max.23W

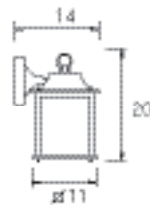
IP 23   6 



05-8726-18-37 

 E-27 max. 100W

IP 23   12 

TRITON

Materiales / Materials



Especificaciones / Specifications



Acabados / Finishes

- 05 Negro
- Black
- Noir
- Schwarz
- Nero
- Preto



223



05-8959-05-37 ■

 E-27 max. 100W

 PL elect. E-27 max. 18W

IP 44   4 

OCEANO

224

Materiales / Materials



Especificaciones / Specifications



Acabados / Finishes

- 18 Marrón óxido
Rusted/oxide brown
Rouille
Rostbraun
Marrone ossido
Marrom óxido

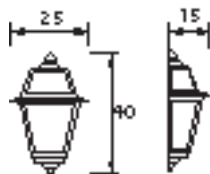

05-9158-18-AA ■

○ E-27 max. 100W

■ PL elect. E-27 max. 23W

IP 23   6 

 18W **Included**

PERSEO

Materiales / Materials



Especificaciones / Specifications



Acabados / Finishes

- 18 Marrón óxido
Rusted/oxide brown
Rouille
Rostbraun
Marrone ossido
Marron óxido



225

Perseo

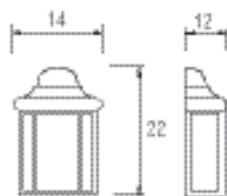

05-8761-18-37 ■

○ E-27 \varnothing 45 max. 60W

■ PL elect. E-27 max. 12W

IP 23 12

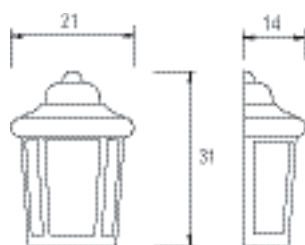

05-8762-18-37 ■

○ E-27 max. 100W

■ PL elect. E-27 max. 21W

IP 23 6

ATLANTIDA

226

Atlantida

Atlantida COLLECTION

- Serie de apliques, todos ellos realizados en aluminio inyectado. Una colección con variedad de difusores, según las necesidades del cliente.
- Wall fixtures made of die-cast aluminium. A collection with a wide variety of diffusers, according to clients' requirements.
- Série d'appliques, toutes réalisées en aluminium injecté. Une collection offrant un large choix de diffuseurs en fonction des besoins du client.
- Apliques realizatos in alluminio iniettato. Una collezione con varietà di diffusori a seconda delle necessità del cliente.
- Apliques feitos em alumínio injectado. Uma coleção com uma grande variedade de difusores, de acordo com as necessidades do cliente.



Características / Specifications



Especificaciones / Specifications



Acabados / Finishes

- 18 Marrón óxido
Rusted/oxide brown
Rouille
Rostbraun
Marrone ossido
Marrom óxido

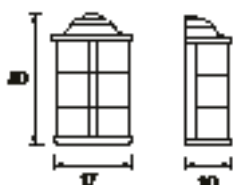

05-9379-18-T2 ■

⊙ E-27 max. 60W

IP 23 6

18W **Included**

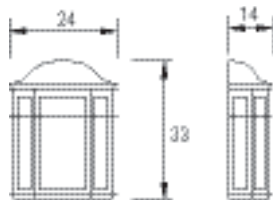

05-8965-18-M3 ■

⊙ 2 x E-27 max. 60W

2 x PL elect. E-27 max.23W

IP 23 6

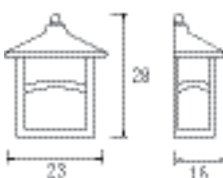

05-9249-18-AA ■ (S)

⊙ E-27 max. 100W

PL elect. E-27 max.18W

IP 23 6

13W **Included**

GALATEA



228

Galatea



Galatea COLLECTION

- La Serie Galatea ofrece una gran variedad de alternativas de iluminación en todo tipo de ambientes señoriales.
- The Galatea Collection offers a wide range of lighting alternatives for all kinds of noble environments.
- La Série Galatea offre une grande variété d'alternatives d'illumination pour tout type d'ambiances seigneuriales.
- Die Produktsérie Galatea bietet eine große Auswahl an Beleuchtungsmöglichkeiten für alle Arten von vornehmen Ambiente.
- La Serie Galatea offre una gran varietà di alternative di illuminazione in qualsiasi tipo di ambiente signorile.
- A Série Galatea oferece uma grande variedade de alternativas de iluminação para todo o tipo de ambientes senhoriais.



Materiales / Materials



Especificaciones / Specifications



Acabados / Finishes

- 18 Marrón óxido
- Rusted/oxide brown
- Rouille
- Rostbraun
- Marrone ossido
- Marrom óxido

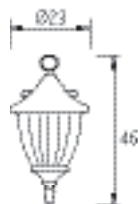

00-9151-18-E7

E-27 max. 100W

PL elect. E-27 max. 23W

IP 23 4

18W **Included**



05-9151-18-E7

E-27 max. 100W

PL elect. E-27 max. 23W

IP 23 4

18W **Included**

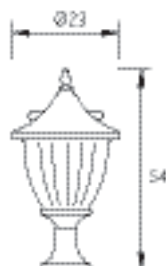

10-9151-18-E7

E-27 max. 100W

PL elect. E-27 max. 23W

IP 23 4

18W **Included**





Materiales / Materials



Especificaciones / Specifications



Acabados / Finishes

- 18 Marrón óxido
Rusted/oxide brown
Rouille
Rostbraun
Marrone ossido
Marrom óxido

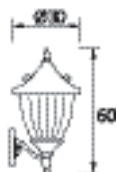

05-9152-18-E7

3 x E-14 max. 60W

IP 23

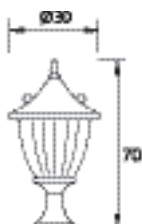

10-9152-18-E7

3 x E-14 max. 60W

IP 23

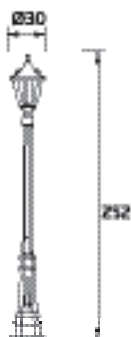

60-9151-18-E7

3 x E-14 max. 60W

IP 23

55-9151-18-18

Columna / column

262

farola completa / complete lamp-post

60-9151-18-E7 + 55-9151-18-18



60-9152-18-E7

3 x E-27 max. 100W

3 x PL elect. E-27 max. 23W

IP 23

18W Included

55-9151-18-18

Columna / column

262

farola completa / complete lamp-post

60-9152-18-E7 + 55-9151-18-18





Olimpo COLLECTION

- La Serie Olimpo ofrece una amplia variedad de opciones al cuatro caras. Fabricada en aluminio inyectado y con difusor de cristal transparente incluye un cristal de recambio de cortesía.
- The Olimpo collection offers a wide range of options, with a four-side design. It is made of die-cast aluminium and transparent glass diffuser, and includes a courtesy spare glass.
- La Série Olimpo propose une grande variété d'options pour les modèles à quatre faces. Fabriquée en aluminium injecté et avec un diffuseur en verre transparent, cette série inclut un verre de rechange offert.
- Die Produktserie Olimpo, mit vier Seiten, bietet eine Vielfalt an Anwendungsmöglichkeiten. Sie ist aus gespritztem Aluminium hergestellt und verfügt über einen transparenten Kristalldiffusor, außerdem schließt sie ein nicht angerechnetes Ersatzkristall ein.
- La Serie Olimpo offre un'ampia varietà di opzioni per il quattro facce. Fabbricata in alluminio iniettato e con un diffusore di cristallo trasparente comprende un cristallo di ricambio omaggio.
- A Série Olimpo oferece uma grande variedade de opções de quatro faces. Fabricada em alumínio injectado e com difusor de vidro transparente, inclui um vidro de substituição como oferta.



Materiales / Materials



Especificaciones / Specifications



Acabados / Finishes

- 05 Negro
- Black
- Noir
- Schwarz
- Nero
- Preto

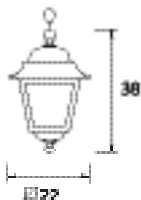

00-8715-05-37 ■

- E-27 max. 100W
- PL elect. E-27 max. 23W

IP 23 6

Included

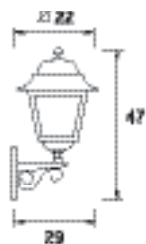

05-8715-05-37 ■

- E-27 max. 100W
- PL elect. E-27 max. 23W

IP 23 6

Included

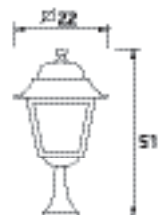

10-8715-05-37 ■

- E-27 max. 100W
- PL elect. E-27 max. 23W

IP 23 6

Included



Materiales / Materials



Especificaciones / Specifications



Acabados / Finishes

- 05 Negro
- Black
- Noir
- Schwarz
- Nero
- Preto

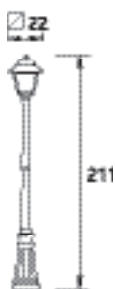

60-8772-05-37 ■

- E-27 max. 100W
- PL elect. E-27 max.23W
- IP 23 2

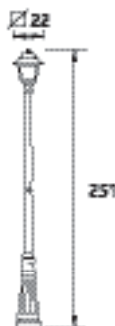

55-8793-05-05 ■

Columna / column



set completo / complete lamp-post

60-8772-05-37 + 55-8793-05-05

55-8766-05-05 ■

Columna / column



set completo / complete lamp-post

60-8772-05-37 + 55-8766-05-05

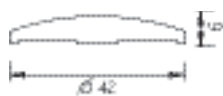

71-9206-05-05 ■

Contrapeso para farolas / Balancing weight for lampost



ATLANTE



236

Atlante



Atlante COLLECTION

- Atlante es el faro cuatro caras clásico, disponible tanto en applique como en farola de dos alturas.
- Atlante is the classic four-side lighthouse, available as wall fixture and two-height lamp-post.
- L'Atlante représente le réverbère classique à quatre faces, disponible en applique comme en réverbère à deux hauteurs.
- Atlante ist ein klassischer Scheinwerfer mit vier Seiten und ist sowohl als Wandleuchte als auch als Laterne in zwei Höhenrößen erhältlich.
- Atlante è il faro quattro facce classico, disponibile tanto in applique quanto in lampione di due altezze.
- Atlante é o farol de quatro faces clássico, disponível tanto em applique como em farol de duas alturas.



Materiales / Materials



Especificaciones / Specifications



Acabados / Finishes

- 05 Negro
- Black
- Noir
- Schwarz
- Nero
- Preto

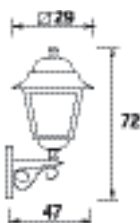

● **05-9103-05-37** ■

- E-27 max. 200W
- PL elect. E-27 max.30W
- ⚡ Mezcía E-27 max. 160W

IP 23 2

Included

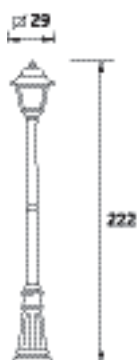

● **60-9103-05-37** ■

- E-27 max. 200W
- PL elect. E-27 max.30W
- ⚡ Mezcía E-27 max. 160W

IP 23 2

Included

55-8793-05-05 ■

Columna / column

262

farola completa / complete lamp-post

60-9103-05-37 + 55-8793-05-05



55-8766-05-05 ■

Columna / column

262

farola completa / complete lamp-post

60-9103-05-37 + 55-8766-05-05

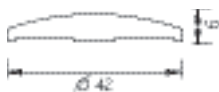

71-9206-05-05 ■ (S)

Contrapeso para farolas / Balancing weight for lampost

2



MOIRA

238

Moira

Moira COLLECTION

- La serie Moira emula piedras iluminadas en el camino con la ventaja de que se pueden distribuir sin necesidad de instalación y funcionando con energía solar. (Ver opción).
- The Moira Collection emulates illuminated stones on a path, with the advantage that they can be distributed without having to be installed and they work with solar power. (See option).
- La Série Moira consiste en des pierres illuminées posées sur le chemin, offrant l'avantage de pouvoir les distribuer sans avoir besoin de les installer étant donné qu'elles fonctionnent avec l'énergie solaire. (Voir option).
- Die Produktserie Moira ähnelt leuchtenden Steinen am Weg. Sie besitzt den Vorteil, dass die Leuchten ohne Installation verteilt werden können, da sie durch Sonnenenergie betrieben werden (siehe Option).
- La serie Moira imita pietre illuminate nel camino, con il vantaggio di poter distribuire gli elementi senza necessità di installazione, dal momento che funzionano a energia solare. (Vedi opzione).
- A série Moira simula pedras iluminadas no caminho com a vantagem de poderem ser distribuídas sem a necessidade de instalação e funcionando com energia solar. (Ver opção).





- B8 Satinado ácido 2 caras
Acid satin 2 sides
Satiné à l'acide des deux cotés
Satinato ácido 2 facie
Beidseitig satiniert
Acetinado ácido 2 caras

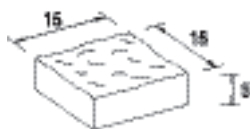

55-9216-B8-B8 □ (S)

16 LEDS X 0,1W 1,6W-230V

IP 67

 12
 + + Caja de conexiones / Connexion box **Included**

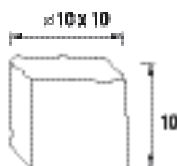

55-9304-B8-B8 □ (S)

4 LEDS X 0,1W 0,4W

IP 67

 12



55-9302-B8-B8 □ (S)

Set de 3 piezas / Set of 3 items

1 LED X 0,1W

IP 67

 12



55-9303-B8-B8 □ (S)

Set de 3 piezas / Set of 3 items

1 LED X 0,1W

IP 67

 12



55-9244-B8-B8 □ (S)

4 LEDS X 0,1W 0,4W

IP 67

 12



55-9246-B8-B8 □ (S)

Set de 3 piezas / Set of 3 items

1 LED 0,1W

IP 67

 12

CUBIK

Cubik COLLECTION

- Cubo con formas orgánicas iluminado con LEDs RGB, que a su vez, puede ser utilizado como asiento.
- Cube with organic forms lit up by LEDs RGB which, in turn, may be used as a seat.
- Cube aux formes organiques éclairé au moyen de LED RGB et pouvant également servir d'assise.
- Würfel mit natürlichen Formen, der mit RGB-LEDs beleuchtet ist und gleichzeitig als Sitzgelegenheit benutzt werden kann.
- Cubo con forme organiche, illuminato con LED RGB, che a sua volta può essere utilizzato come sedile.
- Cubo com formas orgánicas iluminado com LED's RGB, que pode igualmente ser utilizado como assento.



Materiales / Materials



Incluido / Included



Especificaciones / Specifications



Acabados / Finishes

- M1 Blanco mate
- Matt white
- Blanc mate
- Weiß mat
- Bianco matt
- Branco satinado



55-9332-M1-M1 □

LED RGB 3 x 1W - 230V

IP 67

Puede usarse como asiento - Max. 110 Kg.
It can be a sitting place - Max. 110 kg



71-9332-00-00

Un mando a distancia puede controlar multitud de cubos.
A remote control can monitor several cubes.

4

Materiales / Materials



Especificaciones / Specifications



Acabados / Finishes

- Y4 Acero inoxidable
- Stainless steel
- Acier inoxydable
- Rostfreier Stahl
- Acciaio inossidabile
- Aço inoxidável

Incluido / Included

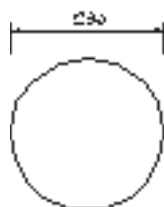

55-9155-Y4-M1

○ E-27 max. 100W

■ PL elect. E-27 max. 23W

IP 44 2

18W **Included**

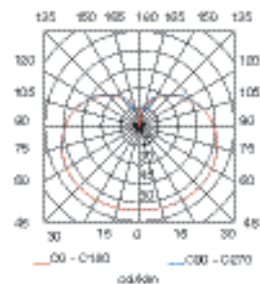

55-9156-Y4-M1

○ E-27 max. 150W

■ PL elect. E-27 max. 23W

IP 44 2

18W **Included**

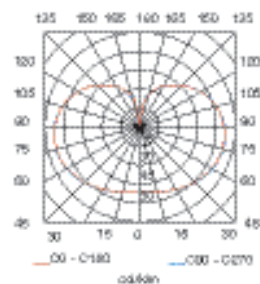



71-9403-34-34 ■

Controlador RGB 230V hasta 50W
RGB Control System 230V up to 50W

IP 54 2



71-9404-34-34 ■

Controlador RGB 230V hasta 100W
RGB Control System 230V up to 100W

IP 54 2

¿POR QUÉ LO LLAMAMOS EASY RGB? WHY IT IS CALLED EASY RGB



Toda la instalación se realiza mediante cables standard de 3 polos.

The whole installation is carried out by means of Standard 3-pole wires.



Podemos usar el pulsador situado en el lateral de la caja del controlador para cambiar el programa en caso de pérdida o falta de batería del mando a distancia.

We can use the button located on the side of the controller box to change the program in case of dead battery or loss of the remote control.



Toda la instalación se realiza con conectores standard.

The whole installation is carried out with Standard connectors.



Un pequeño LED rojo situado en el lateral de la caja del controlador nos indica que hay un cruce en alguna parte de la instalación.

A red LED placed on the side of the controller box shows that there is a short circuit in some part of the installation.

EJEMPLO DE INSTALACIÓN INSTALLATION SAMPLE

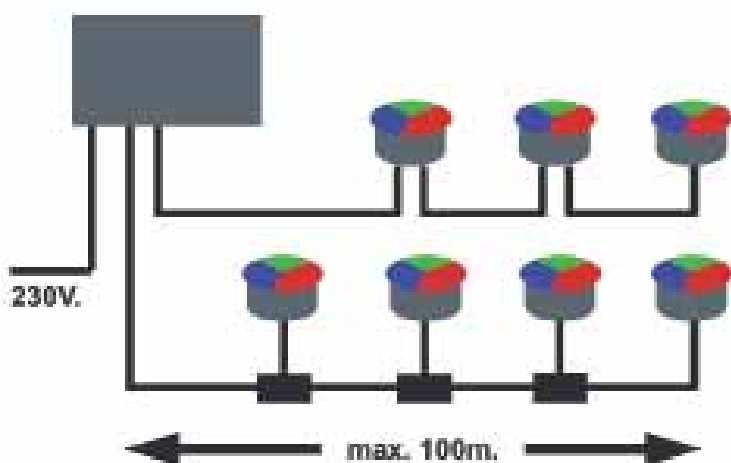

Con el controlador de 100W podemos conectar, por ejemplo, 17 aparatos de 3W + 5 de 9W.
With the 100W controller we can connect, for example, 17x3W + 5x9W appliances.

POSICIONES DEL PROGRAMA PROGRAM POSITIONS

1	
2	
3	
4	
5	
6	
7	blanco - white
* 8	
** 9	
10	apagado - off

* 2 flash, cambia todos los colores uno a uno durante 90 segundos y vuelve a empezar.
2 flash, changes all the colours one by one for 90 seconds and restarts.

** 4 flash, cambia todos los colores uno a uno durante 330 segundos y vuelve a empezar.
4 flash, changes all the colours one by one for 330 seconds and restarts.



Heads COLLECTION [®]

- Colección de farolas de diseño moderno con difusor matizado ideal para iluminar entornos públicos o residenciales. Existen versiones con y sin cubierta superior. Novedosa serie que permite la sustitución de las lámparas sin herramientas.
- A collection of design lamp-posts with a tinged diffuser, ideal for lighting public or residential areas. They come with or without a top cover. The lamps of this novelty collection can be replaced without tools.
- Une collection de réverbères au design moderne avec diffuseur teinté idéal pour illuminer les zones résidentielles ou publiques. Il existe plusieurs versions avec ou sans protection supérieure. Une nouvelle série qui permet de remplacer les lampes sans outils.
- Eine Kollektion von Laternen mit modernem Design und regulierbarem Diffusor. Sie sind besonders für die Beleuchtung von öffentlichen Gebieten oder Wohnvierteln geeignet. Zur Verfügung stehen Ausführungen mit und ohne obere Abdeckung. Es handelt sich um eine neue Produktserie, die einen Lampenaustausch ohne Benutzung von Werkzeugen erlaubt.
- Collezione di lampioni dal design moderno con diffusore dal colore armonizzabile ideale per illuminare spazi pubblici o residenziali. Esistono versioni con e senza copertura superiore. Serie innovativa che permette la sostituzione delle lampade senza bisogno di utensili.
- Colecção de faróis de concepção moderna com difusor matizado ideal para a iluminação de ambientes públicos ou residenciais. Há versões com e sem cobertura superior. Série inovadora que permite a substituição das lâmpadas sem ferramentas.

[®] Registration number: 000966874-030 / 000966874-029

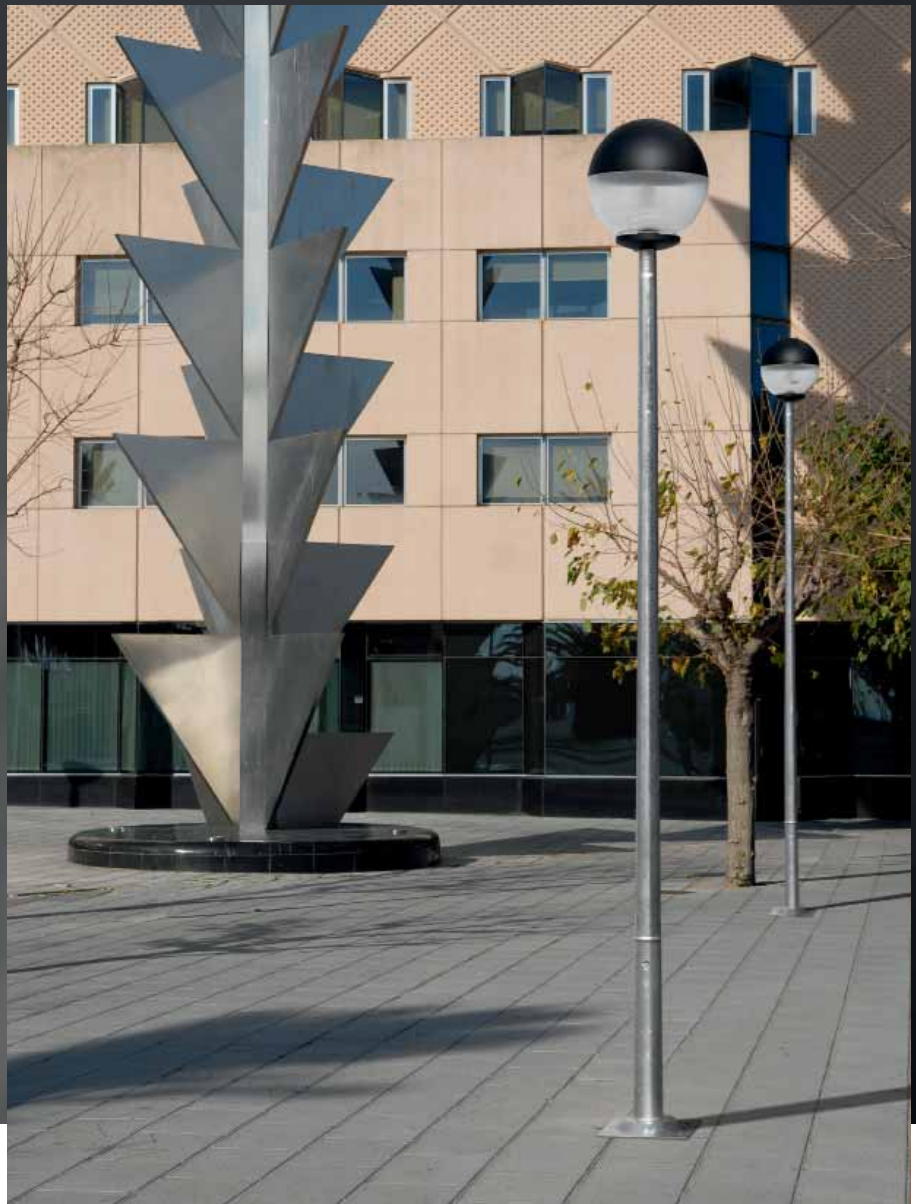

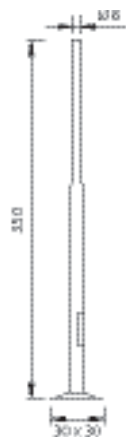

55-9305-48-48 ■

Columna 3,5 m / 3,5 m. column



Kit de instalación incluido.
Installation kit included.
Kit d'installation compris.
Einbaukit inklusive.
Kit installazione incluso.
Kit de instalação incluso.



71-9442-00-00

Kit sodio alta presión y halogenuros metálicos 70W para 60-9375 y 60-9376
70W high pressure sodium and metal halide Kit for 60-9375 and 60-9376

E-27 max. 70W

IP 65 IK 08



71-9399-05-05 ■

Accesorio anti-contaminación lumínica para 60-9375 y 60-9376
Anti light pollution accessory for 60-9375 and 60-9376



71-9398-05-05 ■

Accesorio anti-contaminación lumínica para 60-9306 y 60-9307
Anti light pollution accessory for 60-9306 and 60-9307

Materiales / Materials



Sustitución de la lámpara sin herramientas.
The bulb can be changed without any tools.
Remplacement de la lampe sans outils.
Leuchtmittelerersetzung ohne Werkzeuge.
Sostituzione della lampadina senza degli attrezzi.
Substituição de luminária sem ferramenta

Especificaciones / Specifications



Acabados / Finishes

48 Acero galvanizado.
Galvanised steel.
Acier galvanisé.
Galvanisiertes Stahl.
Acciaio galvanizzato.
Aço galvanizado.

Z5 Gris urbano
Urban grey
Gris urbain
Stadtgrau
Grigio urbano
Cinzento urbano



60-9375-Z5-M3 ■

E-27 max. 150W

PL elect. E-27 max. 30W

IP 65 2 IK 08

E-27 100W

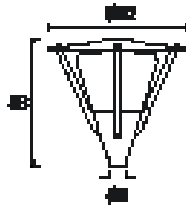
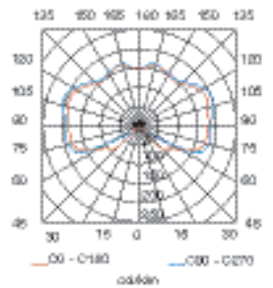

60-9376-Z5-M3 ■

E-27 max. 150W

PL elect. E-27 max. 30W

IP 65 2 IK 08

E-27 100W

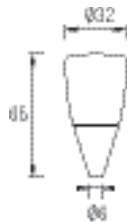
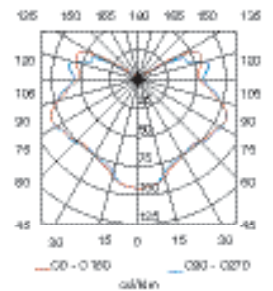

60-9306-Z5-M3 ■

E-40 150W

IP 65 2 IK 08

Included

60-9306 + 71-9398

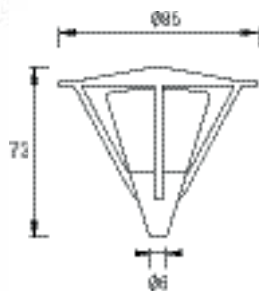
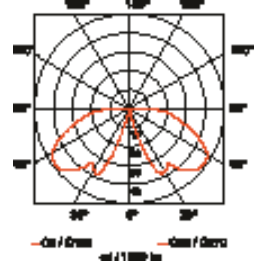

60-9307-Z5-M3 ■

E-40 150W

IP 65 2 IK 08

Included

60-9307 + 71-9398

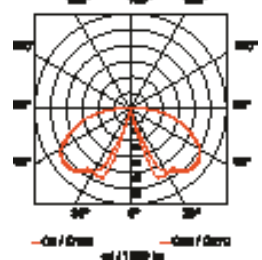



Materiales / Materials



Especificaciones / Specifications



Acabados / Finishes

- | | |
|---|--|
| 05 Negro
Black
Noir
Schwarz
Nero
Preto | 48 Acero galvanizado.
Galvanised steel.
Acier galvanisé.
Galvanisiertes Stahl.
Acciaio galvanizzato.
Aço galvanizado. |
|---|--|



60-9441-05-M2 ■

E-27 max. 100W

PL elect. E-27 max. 30W

IP 44 6 IK 08

Sustitución de la lámpara sin herramientas.
The bulb can be changed without any tools.
Remplacement de la lampe sans outils.
Leuchtmittelerersetzung ohne Werkzeuge.
Sostituzione della lampadina senza degli attrezzi.
Substituição de luminária sem ferramenta



55-9305-48-48 ■

Columna 3,5 m / 3,5 m. column

264



Kit de instalación incluido.
Installation kit included.
Kit d'installation compris.
Einbaukit inklusive.
Kit installazione incluso.
Kit de instalação incluso.



Temis COLLECTION

- Novedosa colección de diseño moderno formada por apliques y farolas. Las columnas están realizadas en aluminio extrusionado y difusor de policarbonato. La gran variedad de alturas de las columnas permiten múltiples combinaciones. Los modelos están disponibles con lámparas de bajo consumo e incluyen reflectores anti-contaminación lumínica.
- A novelty collection of modern-design wall fixtures and lamp-posts. The columns are made of extruded aluminium and a polycarbonate diffuser. The columns come in different heights, which enable multiple combinations. The models are available with energy-saving lamps and include reflectors against light pollution.
- Une nouvelle collection au design moderne composée de balises et appliques. Les corps sont en aluminium extrudé et le diffuseur en polycarbonate. La grande variété de hauteurs des corps permet plusieurs combinaisons. Les modèles sont disponibles avec des lampes basse consommation et sont équipés de réflecteurs contre la contamination de lumière.
- Eine neue Kollektion von modernem Design, bestehend aus Wandleuchten und Laternen. Für die Säulen wurde extrudiertes Aluminium und ein Diffusor aus Polykarbonat verwendet. Die große Auswahl an Größen und Höhen, bietet mehrere Kombinationsmöglichkeiten. Die Modelle sind auch mit Sparlampen erhältlich und sie schließen umweltschützende Leuchtreflectoren ein.
- Innovativa collezione dal design moderno formata da applique e lampioni. Le colonne sono realizzate in alluminio estruso e diffusore in policarbonato. La grande varietà di altezza delle colonne permette combinazioni multiple. I modelli sono disponibili con lampade a basso consumo e comprendono riflettori anti-inquinamento luminoso.
- Coleção inovadora de concepção moderna composta por apliques e faróis. As colunas são feitas em alumínio extrusionado e difusor de policarbonato. A grande variedade de alturas das colunas permite múltiplas combinações. Os modelos estão disponíveis com lâmpadas de baixo consumo e incluem reflectores anti-contaminação luminosa.

 Registration number: 000835277-0027





Materiales / Materials



Especificaciones / Specifications



Acabados / Finishes

- 34 Gris
- Gris
- Gris
- Grau
- Grigio
- Cinzento

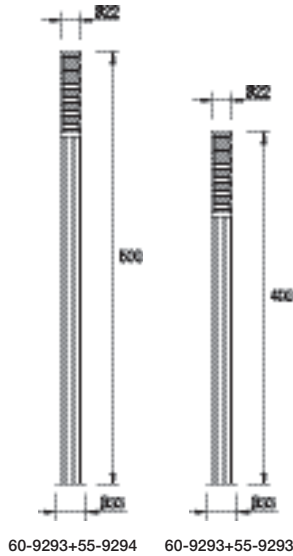

Fluorescente / Fluorescent

60-9293-34-M2 ■

4 x 2G11 80W

IP 65 2 IK 08

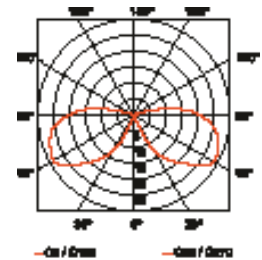

Potencia total: 320W / Total power: 320W.

55-9293-34-34 ■

Columna 4 m / 4 m. column



55-9294-34-34 ■ (S)

Columna 5 m / 5 m. column

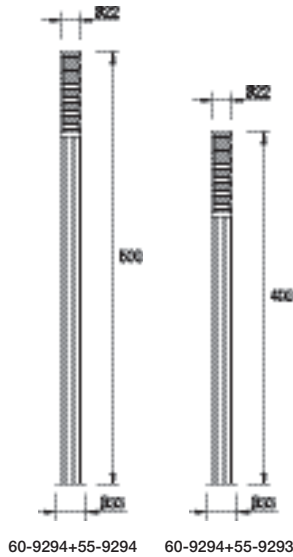

**Sodio de alta presión y Halogenuros metálicos
High pressure sodium and Metal Halide**

60-9294-34-M2 ■ (S)

2 x E-40 150W

IP 65 2 IK 08

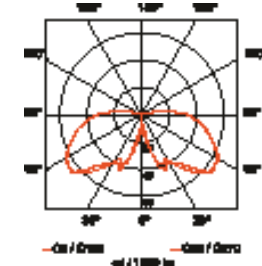

55-9293-34-34 ■

Columna 4 m / 4 m. column



55-9294-34-34 ■ (S)

Columna 5 m / 5 m. column

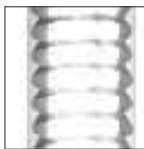

Reflectores anti contaminación lumínica.
Anti light pollution reflectors.
Réflecteurs anti-pollution lumineuse.
Reflektore für eine umweltfreundliche Beleuchtung
Riflettori anti-contaminazione luminica.
Reflectores que previnem a contaminação luminosa.



Superficie estriada para evitar el pegado de adhesivos.
Slotted surface to prevent sticking of adhesives.
Surface striée pour éviter le collage d'adhésifs.
Gestreckte Oberflächen, um das Ankleben von Adhäsivmaterial zu vermeiden
Superficie striata per evitare l'attacco degli adesivi.
Superficie estriada para evitar a colagem de adesivos.



Kit de instalación incluido.
Installation kit included.
Kit d'installation compris.
Einbaukit inklusive.
Kit installazione incluso.
Kit de instalação incluso.

Certificado para la instalación en espacios públicos.
 Certificate for installation in public places.
Certificat pour l'installation dans les espaces publics.
-Zertifikat für die Installation an öffentlichen Orten.
Certificato per la installazione per degli spazi pubblici.
Certificado para instalação em espaços públicos

Materiales / Materials



Especificaciones / Specifications



Acabados / Finishes

- 34 Gris
- Grey
- Gris
- Grau
- Grigio
- Cinzeno

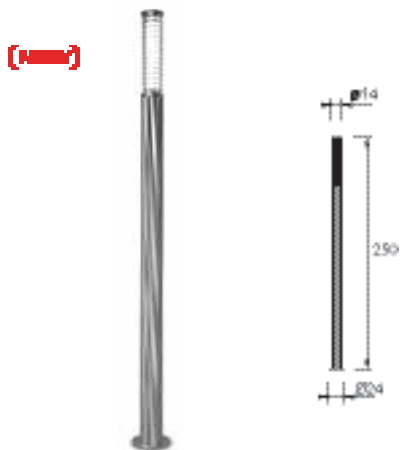

● 55-9431-34-M2 ■

2 x GX24q-4 26-32-42W

IP 65 2 264 IK 08

Included

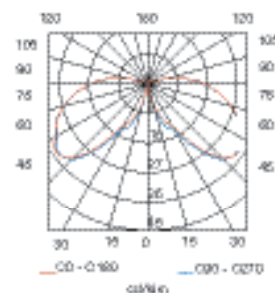

● 55-9268-34-M2 ■

4 x 2G11 55W

IP 65 2 264 IK 08

Included

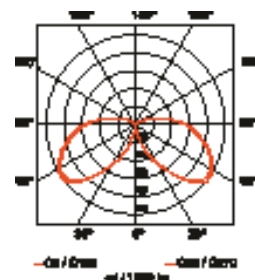

Potencia total: 220W / Total power: 220W.



● 55-9269-34-M2 ■

4 x 2G11 55W

IP 65 2 264 IK 08

Included

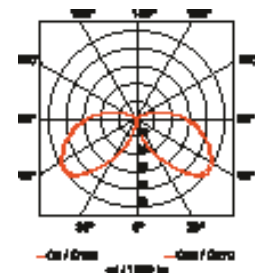

Potencia total: 220W / Total power: 220W.

LUMINARIAS DE ALUMBRADO PÚBLICO

En el catálogo URBAN encontrará una amplia gama de soluciones de alumbrado exterior público.

In URBAN catalogue you can find a wide range of solutions for exterior public system of illumination.



UMA



CÓDIGO/ CODE **DESCRIPCIÓN/ DESCRIPTION**

80-3153-BK-H6	150 W VSAP/HM / 150W HPS/MH
80-3159-BK-H6	150 W VSAP 2N / 150W HPS BIPOWER
80-3163-BK-H6	150 W VSAP 2N TEMP / 150W HPS/MH BIPOWER TIMED
80-3167-BK-H6	150 W VSAP/HM C-II / 150W HPS/MH C-II
80-3171-BK-H6	150 W VSAP 2N C-II / 150W HPS/MH BIPOWER C-II
80-3195-BK-H6	150 W VSAP 2N C-II TEMP / 150W BIPOWER TIMED C-II

Potencia disponible 70W-250W
Available power: 70W-250W

FHS INST = 0,1 %
VSAP 150W



Altura de montaje: 4 - 7 m
Assembled height: 4 - 7 m

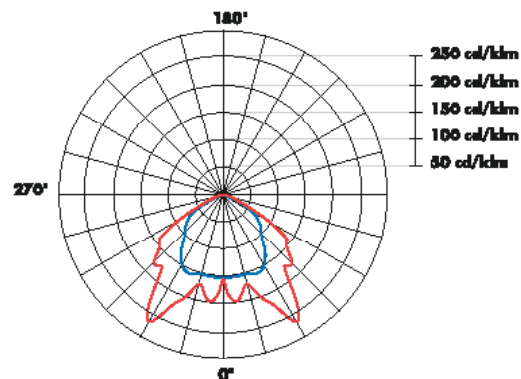
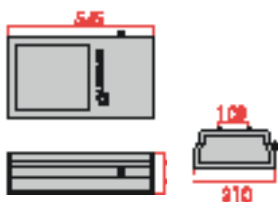

MAXI FLOOD



CÓDIGO/ CODE **DESCRIPCIÓN/ DESCRIPTION**

80-3199-BO-H6	150 W VSAP/HM / 150W HPS/MH
80-4447-BO-H6	150 W VSAP 2N / 150W HPS BIPOWER
80-4452-BO-H6	150 W VSAP 2N TEMP / 150W HPS/MH BIPOWER TIMED
80-4457-BO-H6	150 W VSAP/HM C-II / 150W HPS/MH C-II
80-4462-BO-H6	150 W VSAP 2N C-II / 150W BIPOWER HPS/MH C-II
80-4467-BO-H6	150 W VSAP 2N C-II TEMP / 150W BIPOWER TIMED C-II

Potencia disponible 70W-400W
Available power: 70W-400W

FHS INST = 0,1 %
VSAP 150W



Altura de montaje: 4-12 m
Assembled height: 4 - 12 m

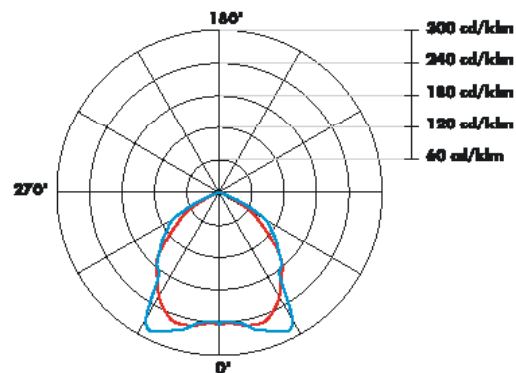
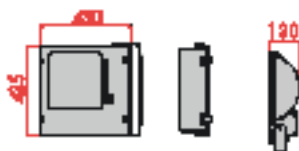

* Consultar condiciones comerciales.
* Consult commercial conditions.
* Consulter les conditions commerciales.

* Handelsbedingungen abfragen.
* Consultare le condizioni commerciali.
* Consultar condições comerciais.

Para ampliar información, consultar catálogo URBAN.
For more information, please consult URBAN catalogue.

ROADWAY



CÓDIGO/ CODE **DESCRIPCIÓN/ DESCRIPTION**

80-3073-AT-37	150W VSAP/HM / 150W HPS/MH
80-3076-AT-37	150W VSAP 2N / 150W HPS BIPOWER
80-3085-AT-37	150W VSAP 2N TEMP / 150W HPS BIPOWER TIMED
80-3089-AT-37	150W VSAP/HM CLASE II / 150W HPS/MH C-II
80-3093-AT-37	150W VSAP 2N C-II / 150W HPS BIPOWER C-II
80-3097-AT-37	150W VSAP 2N C-II TEMP / 150W HPS BIPOWER TIMED C-II

Potencia disponible 70W-250W
Available power: 70W-250W



Altura de montaje: 4 - 10 m
Assembled height: 4 - 10 m

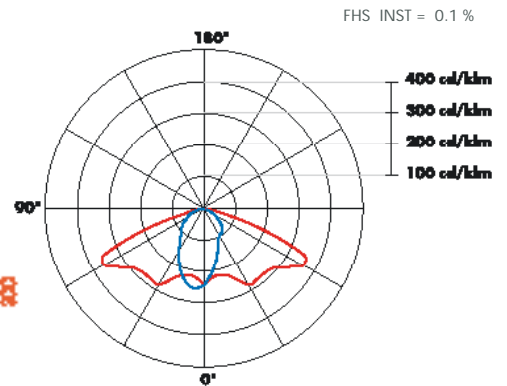

CITIZEN



CÓDIGO/ CODE **DESCRIPCIÓN/ DESCRIPTION**

83-3102-BB-M2	2x150W VSAP/HM / 2x150W HPS/MH
83-3105-BB-M2	2x150W VSAP 2N / 2x150W HPS BIPOWER
83-3119-BB-M2	2x150W VSAP 2N TEMP / 2x150W HPS BIPOWER TIMED
83-3186-BB-M2	2x150W VSAP/HM C-II / 2x150W HPS/MH C-II

Potencia disponible 70W-150W
Available power: 70W-150W

FHS INST = 10.3 %
VSAP 2 X 150W

Columna de acero galvanizado pintado negro oxirón
Galvanised steel column painted in black Oxiron

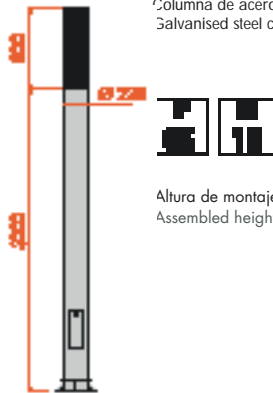

Altura de montaje: 4 m
Assembled height: 4 m

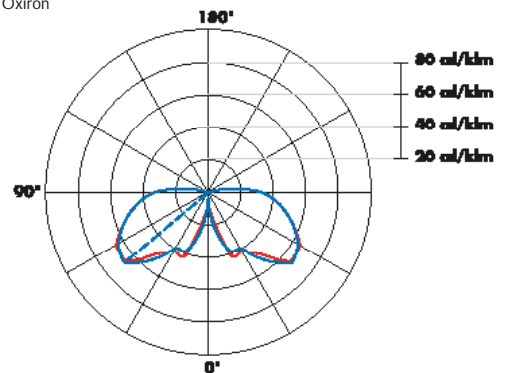

ANDALUCIA



CÓDIGO/ CODE **DESCRIPCIÓN/ DESCRIPTION**

80-4472-BP-37	150 W VSAP/HM / 150W HPS/MH
80-4475-BP-37	150 W VSAP 2N / 150W HPS BIPOWER
80-4478-BP-37	150 W VSAP 2N TEMP / 150W HPS/MH BIPOWER TIMED
80-4484-BP-37	150 W VSAP 2N C-II / 150W BIPOWER C-II
80-4487-BP-37	150 W VSAP 2N C-II TEMP / 150 W BIPOWER TIMED C-II
80-4492-BP-37	SIN EQUIPO / WITHOUT GEAR

Potencia disponible 70W-150W
Available power: 70W-150W

FHS INST = 0.1 %
VSAP 150W

Material: Chapa de hierro
Material: Iron plate



Luminaria Bloque
óptico

Altura de montaje: 3 - 6 m
Assembled height: 3 - 6 m

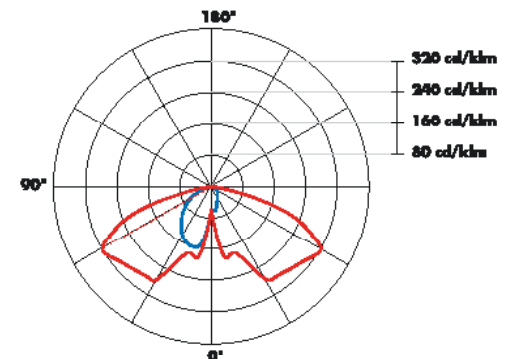
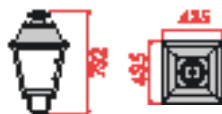

* Consultar condiciones comerciales.
* Consult commercial conditions.
* Consulter les conditions commerciales.

* Handelsbedingungen abfragen.
* Consultare le condizioni commerciali.
* Consultar condições comerciais.

Para ampliar información, consultar catálogo URBAN
For more information, please consult URBAN catalogue.

LUMINARIAS DE ALUMBRADO PÚBLICO

GAVINA II



CÓDIGO/ CODE DESCRIPCIÓN/ DESCRIPTION

80-3046-BS-37	150W VSAP/HM / 150W HPS/MH
80-3049-BS-37	150W VSAP 2N / 150W HPS BIPOWER
80-3056-BS-37	150W VSAP 2N TEMP / 150W HPS/MH BIPOWER TIMED
80-3059-BS-37	150W VSAP/HM C-II / 150W HPS/MH C-II

Potencia disponible 70W-150W
Available power: 70W-150W

FHS INST = 0.0 %
VSAP 150W



Altura de montaje: 4 - 7 m
Assembled height: 4 - 7 m

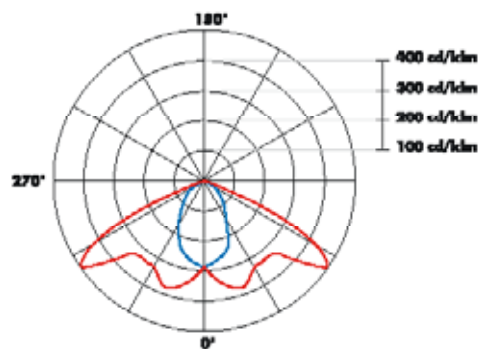
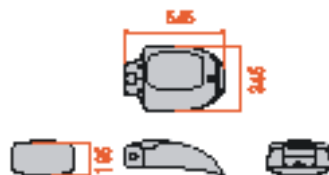

BOHEMIA



CÓDIGO/ CODE DESCRIPCIÓN/ DESCRIPTION

80-3003-BP-37	150W VSAP/HM / 150W HPS/MH
80-3006-BP-37	150W VSAP 2N / 150W HPS BIPOWER
80-3009-BP-37	150W VSAP 2N TEMP / 150W HPS BIPOWER TIMED
80-3028-BP-37	150W VSAP/HM C-II / 150W HPS/MH C-II
80-3175-BP-37	150W VSAP 2N C-II / 150W HPS BIPOWER C-II
80-3178-BP-37	150W VSAP 2N C-II TEMP / 150W HPS BIPOWER TIMED C-II

Potencia disponible 70W-150W
Available power: 70W-150W

FHS INST = 0.1 %
VSAP 150W

Material: Aluminio inyectado
Material: Injected aluminium.



Altura de montaje: 3 - 6 m
Assembled height: 3 - 6 m

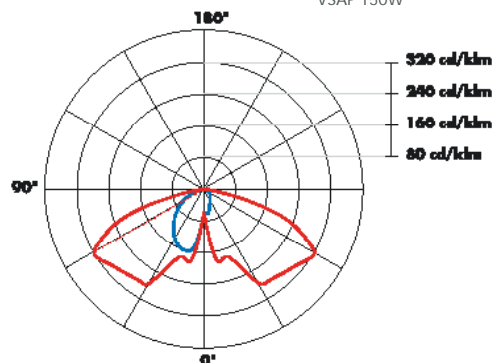

MERIDIAN



CÓDIGO/ CODE DESCRIPCIÓN/ DESCRIPTION

80-3014-BP-37	150W VSAP/HM / 150W HPS/MH
80-3017-BP-37	150W VSAP 2N / 150W HPS BIPOWER
80-3020-BP-37	150W VSAP 2N TEMP / 150W HPS BIPOWER TIME
80-3027-BP-37	150W VSAP 2N C-II / 150W HPS BIPOWER C-II
80-3181-BP-37	150W VSAP 2N C-II TEMP / 150W HPS BIPOWER TIMED C-II

Potencia disponible 70W-150W
Available power: 70W-150W

FHS INST = 0.1 %
VSAP 150W



Altura de montaje: 3 - 6 m
Assembled height: 3 - 6 m

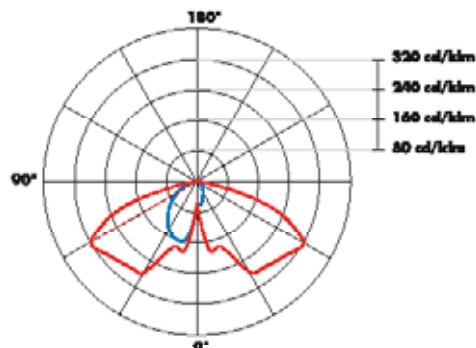

* Consultar condiciones comerciales.
* Consult commercial conditions.
* Consulter les conditions commerciales.

* Handelsbedingungen abfragen.
* Consultare le condizioni commerciali.
* Consultar condições comerciais.

Para ampliar información, consultar catálogo URBAN
For more information, please consult URBAN catalogue.

ELIPSE



CÓDIGO/ CODE DESCRIPCIÓN/ DESCRIPTION

80-3031-BQ-37	150W VSAP/HM / 150W HPS/MH
80-3034-BQ-37	150W VSAP 2N / 150W HPS BIPOWER
80-3041-BQ-37	150W VSAP 2N TEMP / 150W HPS BIPOWER TIMED

Potencia disponible 70W-150W
Available power: 70W-150W

FHS INST = 0.1 %
VSAP 150W



Altura de montaje: 4 - 7 m
Assembled height: 4 - 7 m

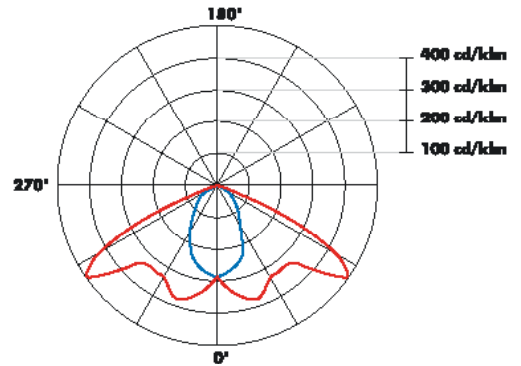
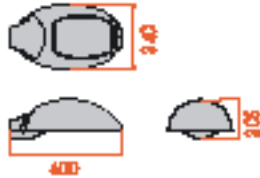

PROMENADE



CÓDIGO/ CODE DESCRIPCIÓN/ DESCRIPTION

83-3023-AX-37	2x36W FLUORESCENTE / 2x36W FLUORESCENT
83-3024-AX-37	2x36W FLUORESCENTE / 2x36W FLUORESCENT
83-3025-AX-37	2x2x36W FLUORESCENTE / 2x2x36W FLUORESCENT

Potencia disponible 36W
Available power: 36W

FHS INST = 0.9 %
2 X OSRAM DULUX 36W/840



Altura de montaje: 3 - 5 m
Assembled height: 3 - 5 m

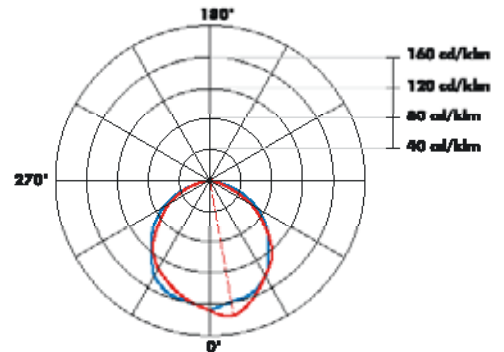
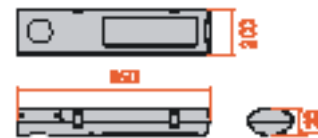

PROMENADE LED



CÓDIGO/ CODE DESCRIPCIÓN/ DESCRIPTION

83-4488-AX-37	COLUMNA PROMENADE 3 MTS + LUMINARIA LED 28W / COLUMN PROMENADE 3 MTS + LUMINAIRE LED 28W
83-4489-AX-37	COLUMNA PROMENADE 5 MTS + LUMINARIA LED 56W / COLUMN PROMENADE 5 MTS + LUMINAIRE LED 56W
83-4490-AX-37	COLUMNA PROMENADE 5 MTS + 2 LUMINARIA LED 28+56W / COLUMN PROMENADE 5 MTS + 2 LUMINAIRE LED 28 + 56W
83-4491-AX-37	COLUMNA PROMENADE 5 MTS + 2 LUMINARIA LED 56+56W / COLUMN PROMENADE 5 MTS + 2 LUMINAIRE LED 56 + 56W

Potencia disponible 28-56W
Available power: 28-56W

FHS INST = 0.9 %



Altura de montaje: 3 - 5 m
Assembled height: 3 - 5 m

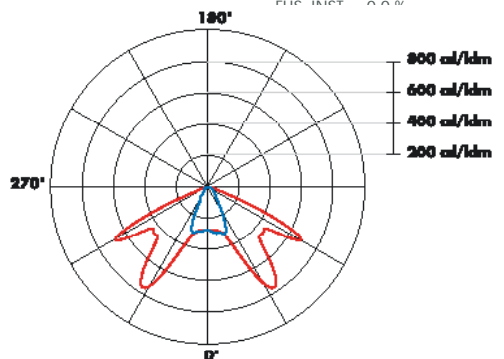
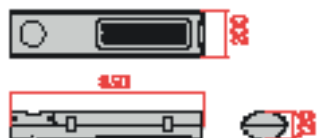

* Consultar condiciones comerciales.
* Consult commercial conditions.
* Consulter les conditions commerciales.

* Handelsbedingungen abfragen.
* Consultare le condizioni commerciali.
* Consultar condições comerciais.

Para ampliar información, consultar catálogo URBAN
For more information, please consult URBAN catalogue.



71-9400-34-34 ■

Caja de conexiones
Multipurpose connection box

IP 54  6



71-9199-05-05 ■

Caja de conexiones estanca. Para cables de $\varnothing 6,5$ a $\varnothing 11$ mm.
Water proof connexion box.

IP 68 1 m  6



71-9262-05-05 ■

Caja de conexiones estanca.
Water proof connexion box.

IP 67  50



71-9311-05-05 ■ (S)

Caja de conexiones estanca. Medidas: 30 x 19 x 12.
Water proof connexion box. measures: 30 x 19 x 12.

IP 67  6



71-9197-05-05 ■

Transformador estanco para lámparas halógenas. 230/12V AC-100W.
Water proof transformer for halogen bulbs. 230/12V AC - 100W.

  IP 68 1 m  6



71-9198-05-05 ■

Fuente de alimentación estanco para LED 230/12V DC - 20W.
Water proof power supply for LED 230/12V DC - 20W.

  IP 68 1 m  6



71-9278-05-05 ■

Fuente de alimentación estanco para POWER LED 230/3V DC - 10W.
Water proof power supply for POWER LED 230/3V DC - 10W.

  IP 68 1 m  6



71-9396-05-05 ■

Conector IP 68 3 vías forma "T" 3 polos. Para cables de $\varnothing 5$ a $\varnothing 13$ mm.
IP 68 connection 3 ways T shape x 3 wires.



71-9397-05-05 ■

Conector IP 68 2 vías 3 polos completo. Para cables de $\varnothing 5$ a $\varnothing 13$ mm.
IP 68 connection 2 ways 3 wires complete.



71-9405-M3-M3 □

Accesorio para aumento hasta IP65. Máx 15W
Accessory to increase up to IP 65. Max 15W



71-9406-M3-M3 □

Accesorio para aumento hasta IP65. Máx 20W
Accessory to increase up to IP 65. Max 20W



71-9273-05-05 ■

Caja para empotrar válida para las referencias: 05-8759, 05-8961, 05-9211 y 05-9212
Flush fitting box valid for references: 05-8759, 05-8961, 05-9211 and 05-9212

50



71-8969-00-00 □

Reactancia para PL G24d-1 13W.
Electronic ballast for PL G24d-1 13W.

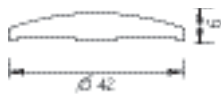

71-9206-05-05 ■

Contrapeso para farolas.
Balancing weight for lampposts.

2

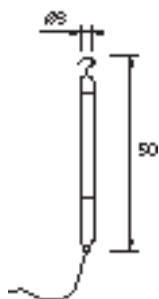

71-8949-05-M2 ■ (S)

Linterna fluorescente
Fluorescent lantern

IP 67 12

T8 8W + included



05-8759
05-8961
05-9211
05-9212

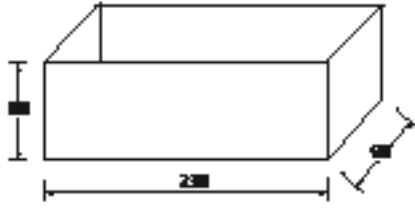

05-9128

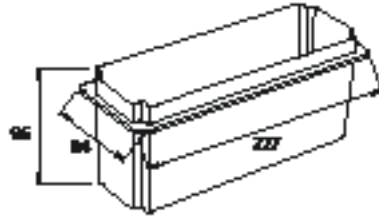

05-9159

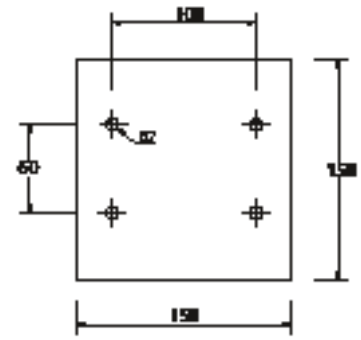

05-9167

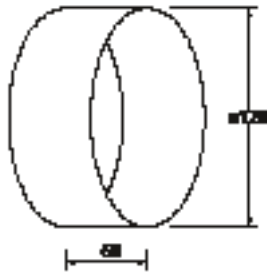

05-9169

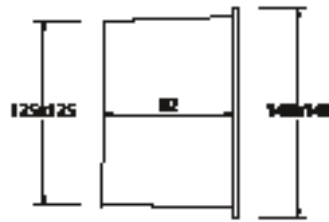

05-9179

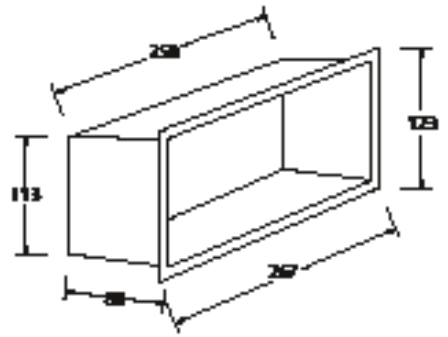

05-9182

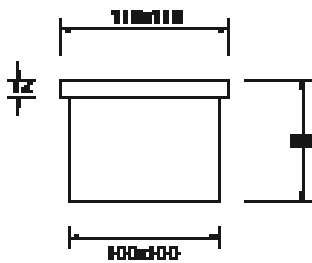

05-9240

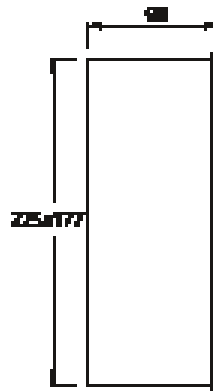

05-9344

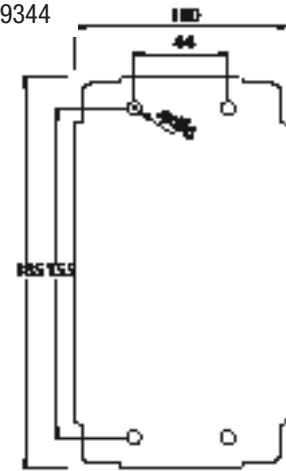

05-9345

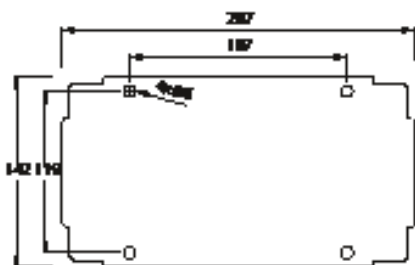

05-9346
05-9407

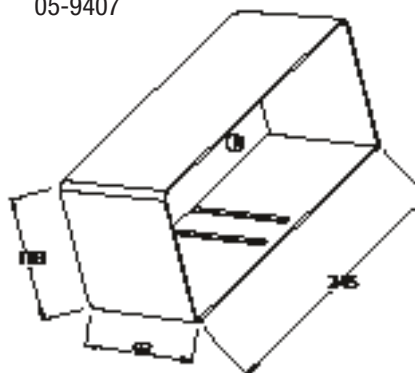

05-9347

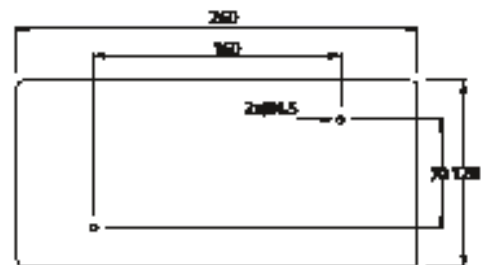

05-9369

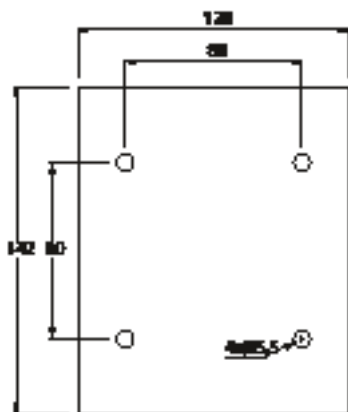

05-9388
05-9434



05-9393

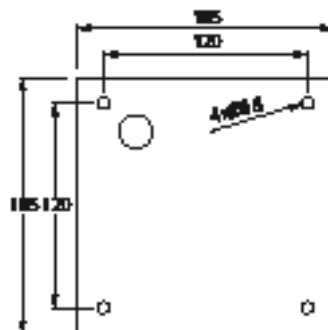

10-8790
10-9333
55-8790
55-9333

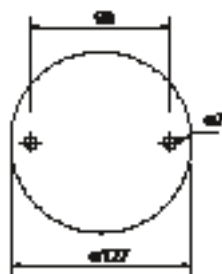

10-9116

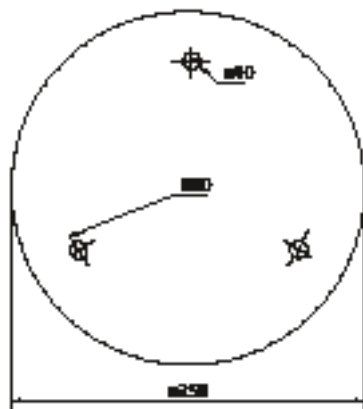

10-9122

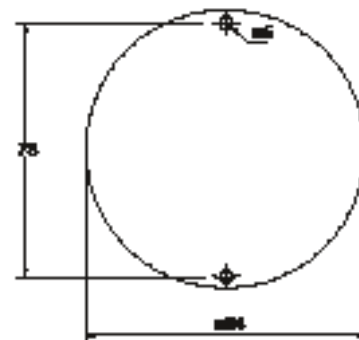

10-9176
55-9176

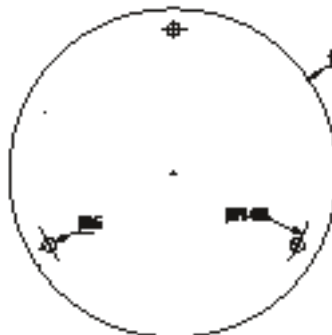

10-9183



10-9195

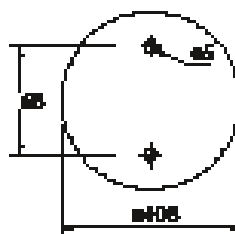

10-9237
55-9237
55-9272



10-9295
55-9295

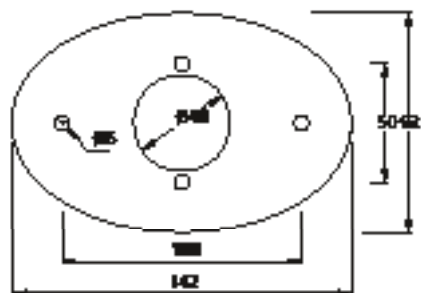

10-9298

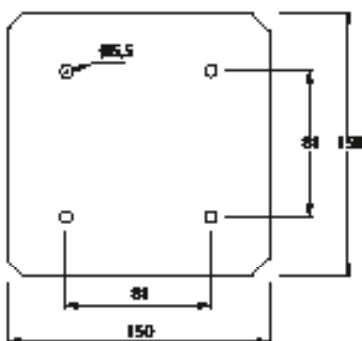

10-9299

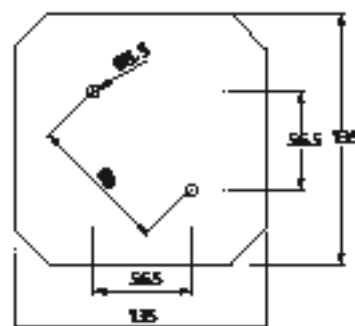

10-9329
55-9329

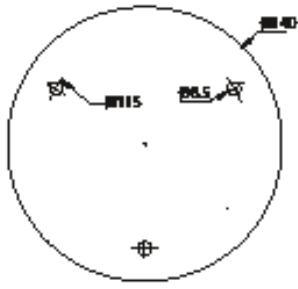

10-9390

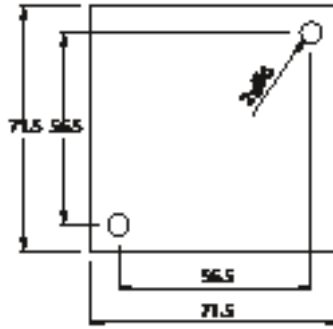

15-9363
15-9364
15-9365

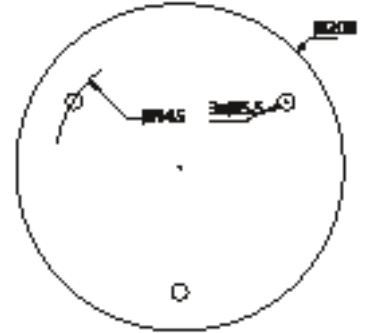

15-9381

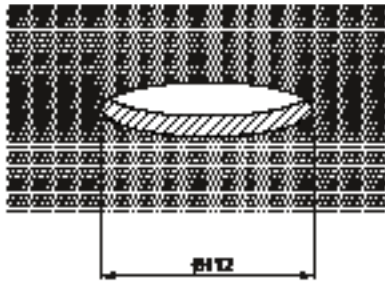

15-9391
15-9392

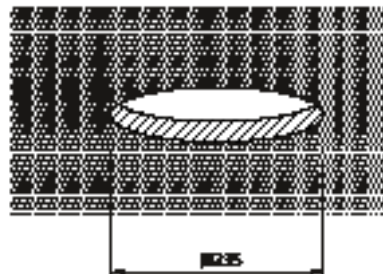

55-8766
55-8793
55-9203

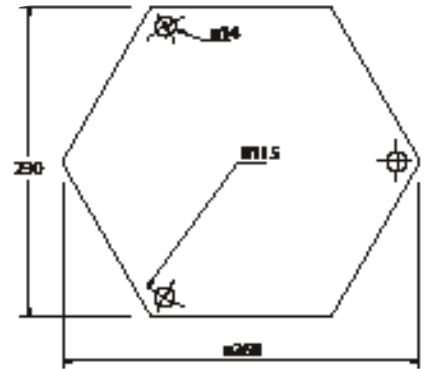

55-8956

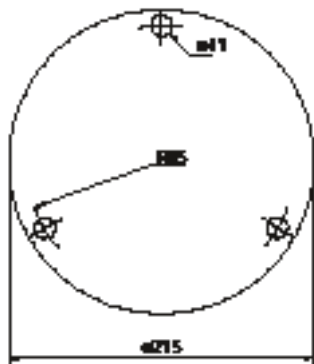

55-9125



55-9128

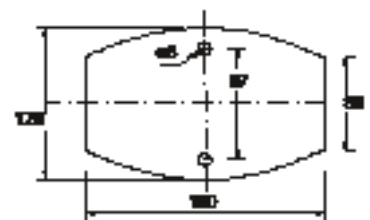

55-9151

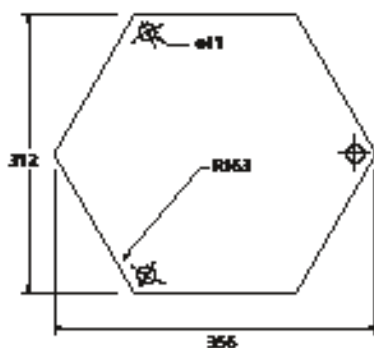

55-9184



55-9186

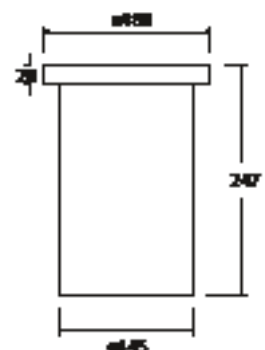

55-9190

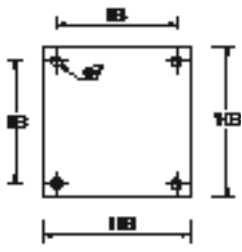

55-9187
55-9323
55-9433

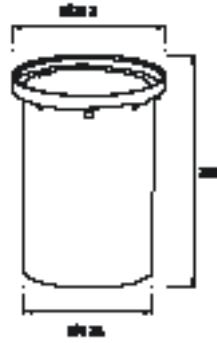

55-9195



55-9232

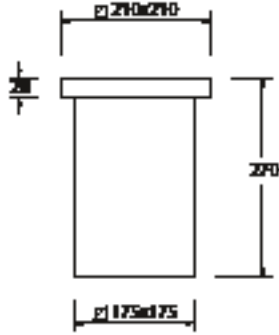

55-9233

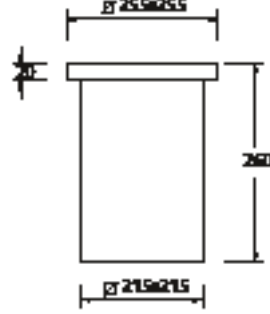

55-9238

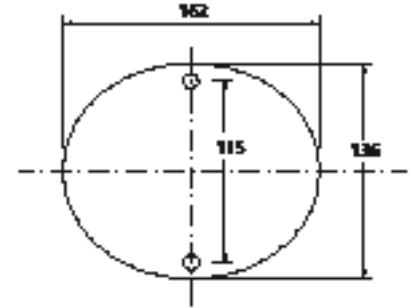

55-9239
55-9440

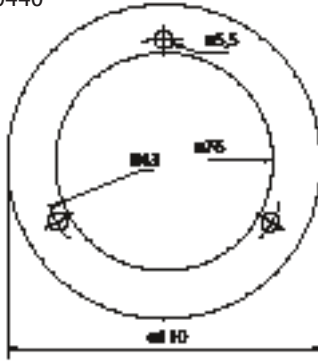

55-9242

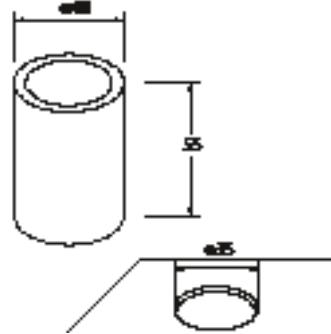

55-9243

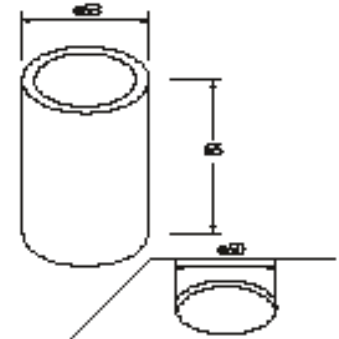

55-9245

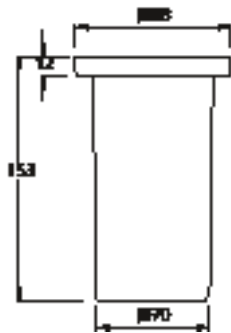

55-9250
55-9251

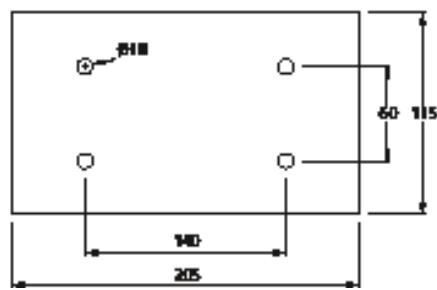

55-9254

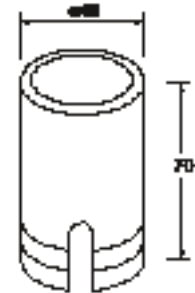

55-9255

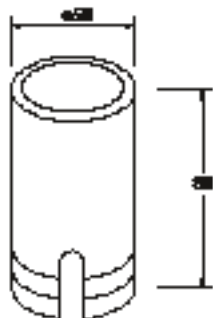

55-9257

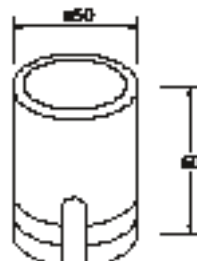

55-9263



55-9264

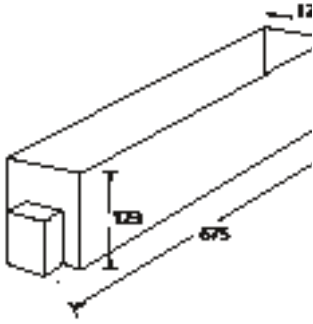

55-9265

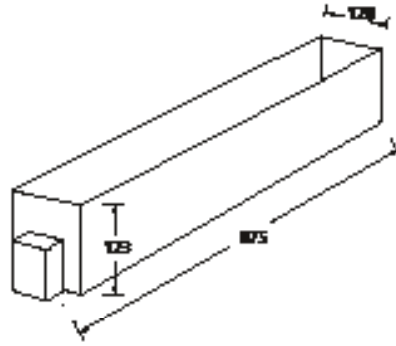

55-9266

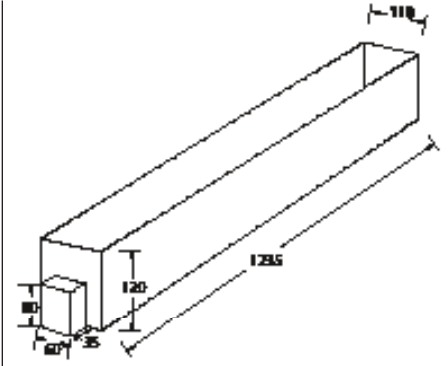

55-9429

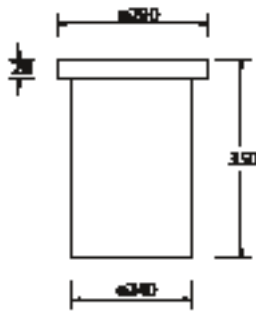

55-9268
55-9269

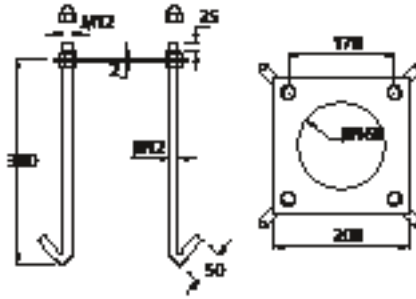

55-9280
55-9281
55-9282
55-9283
55-9380
55-9382
55-9394
55-9423
55-9424
55-9437

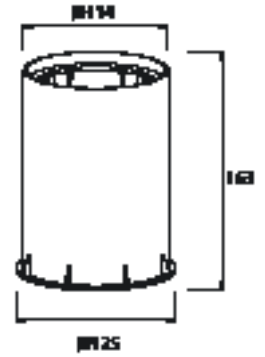

55-9284

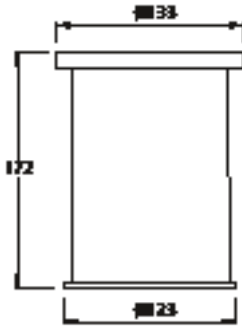

55-9293
55-9294

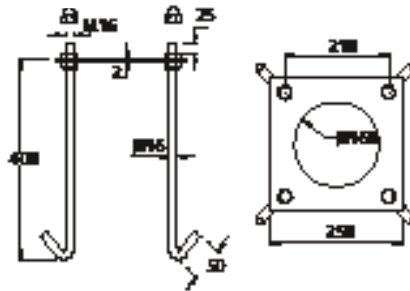

55-9298

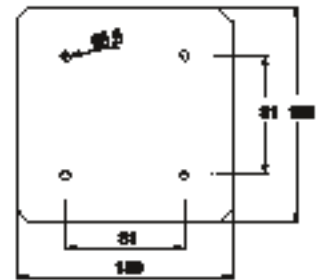

55-9305

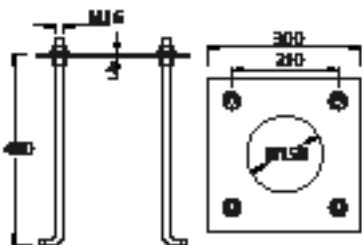

55-9318 55-9335
55-9319 55-9336
55-9320 55-9342
55-9334 55-9343

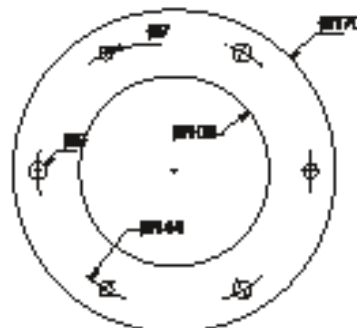

55-9337

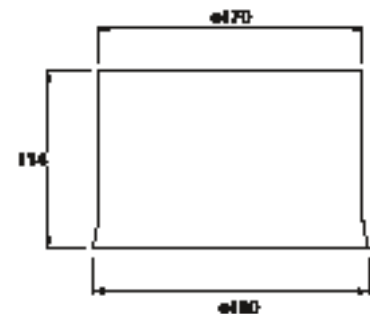

55-9350

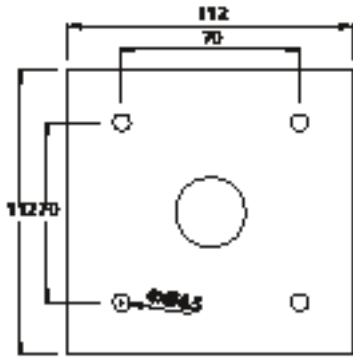

55-9354
55-9355

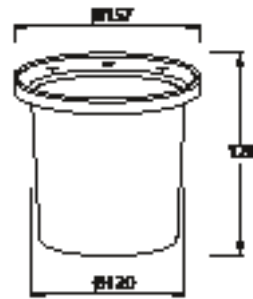

55-9357

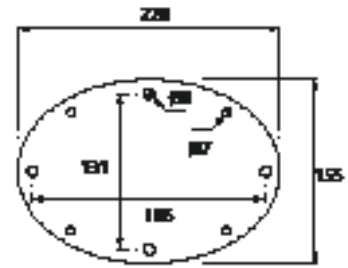

55-9358

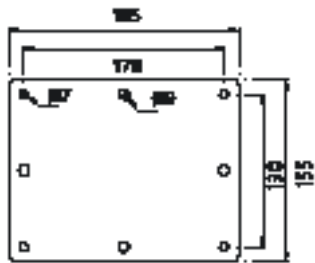

55-9361
55-9374

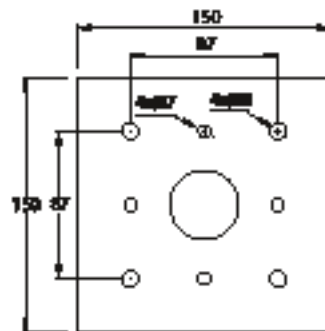

55-9371

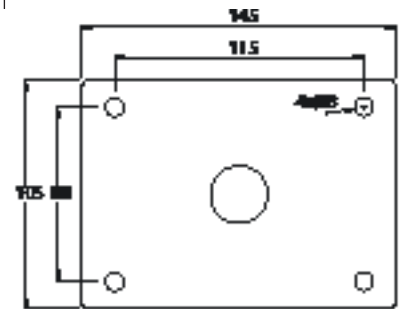

55-9377
55-9378

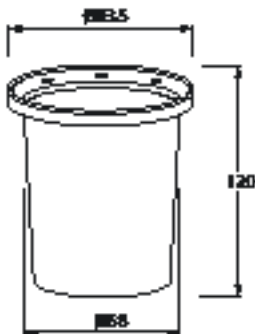

55-9384

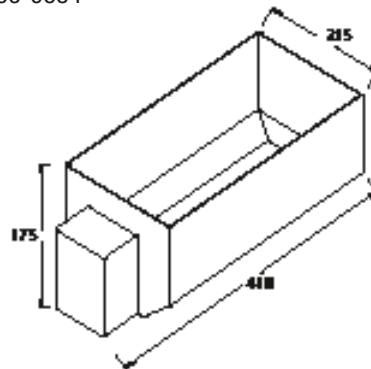

55-9390

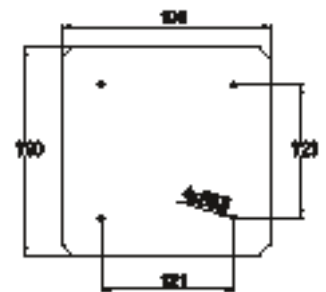

55-9421

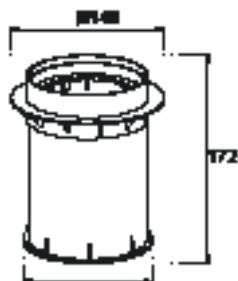

55-9425

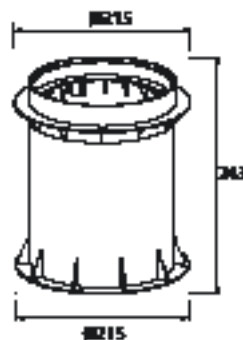

55-9427
55-9428

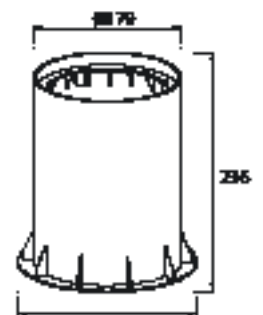

55-9430

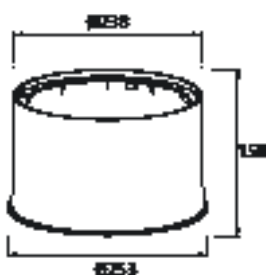

55-9431

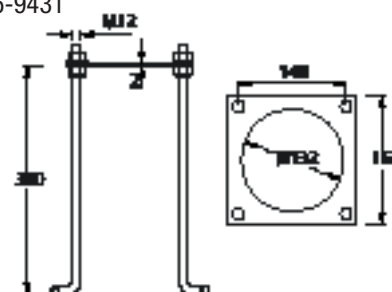

55-9435
55-9443

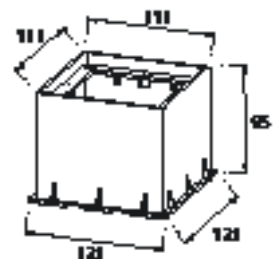



05 Negro
Black
Noir
Schwarz
Nero
Preto



14 Blanco
White
Blanc
Weiß
Bianco
Branco



18 Marrón óxido
Rusted/oxide brown
Rouille
Rostbraun
Marrone ossido
Marrom óxido



92 Madera de Teka
Teak wood
Bois de teck
Teakholz
Legno di teak
Madeira de teka



34 Gris
Grey
Gris
Grau
Grigio
Cinzento
(RAL 9006 aprox/approx)



46 Acero inoxidable acabado teka
Stainless steel teka finish
Acier inoxydable finition aspect teck
Rostfreier Stahl, Fertigverarbeitung in Teakholz
Acciaio inossidabile con finitura teak
Aço inoxidável com acabamento teka



54 Aluminio anodizado
Anodized aluminium
Aluminium anodisé
Elokiertes Aluminium
Alluminio anodizzato
Aluminio anodizado



K7 Gris piedra
Stone grey
Gris pierre
Steingrau
Grigio pietra
Cinzento pedra



M1 Blanco mate
Matt white
Blanc mate
Weiß mat
Bianco matt
Branco satinado



M2 Plástico transparente
Transparent plastic
Plastique transparent
Plastico trasparente
Durchsichtiges Kunststoff
Plástico transparente



B8 Satinado ácido 2 caras
Acid satin 2 sides
Satiné à l'acide des deux cotés
Satinato acido 2 facie
Beidseitig satiniert
Acetinado ácido 2 caras



Y4 Acero inoxidable AISI 304
Stainless steel AISI 304
Acier inoxydable AISI 304
Rostfreier Stahl AISI 304
Acciaio inossidabile AISI 304
Aço inoxidável AISI 304



Y4 Acero inoxidable AISI 316
Stainless steel AISI 316
Acier inoxydable AISI 316
Rostfreier Stahl AISI 316
Acciaio inossidabile AISI 316
Aço inoxidável AISI 316



Z5 Gris urbano
Urban grey
Gris urbain
Stadtgrau
Grigio urbano
Cinzento urbano
(RAL 7010 aprox/approx)



48 Acero galvanizado.
Galvanised steel.
Acier galvanisé.
Galvanisiertes Stahl.
Acciaio galvanizzato.
Aço galvanizado.



J6 Marrón
Brown
Marron
Braun
Marrone
Castanho



AW Terracota
Clay backed
Terre cuite
Terracotta
Terracotta
Terracota



M3 Plástico transparente mate
Matt transparent polycarbonate
Polycarbonate transparent mat.
Transparenter matter polycarbonat.
Polycarbonate transparente matt.
Polycarbonato transparente mate.

MATERIALES / MATERIALS



Acero acabado epoxy.
Epoxy finish steel.
Acier finition exposi.
Stahl, Fertigverarbeitung mit Epoxy-Lackierung.
Acciaio Alluminio pressofuso.
Aço com acabamento epoxy.



Cristal lupa.
Magnifying glass.
Verre de loupe.
Lupenglas.
Cristallo con lente essetto diffondenti.
Vidro tipo lupa.



Cristal transparente.
Transparent glass.
Verre transparent.
Transparenter Glas.
Vicchiere transparente.
Vidro transparente.



Plástico inyectado.
Injected plastic.
Plastique injecté.
Spritzkunststoff.
Plastic iniettato.
Plástico inyectado.



Acero inoxidable
Stainless steel.
Acier inoxydable
Rostfreier Stahl.
Acciaio inossidabile.
Aço inoxidável.



Cristal biselado.
Beveled glass.
Verre biseauté .
Geschliffener Glas.
Cristallo molato.
Vidro com moldura facetada.



Acero inoxidable AISI 304.
Stainless steel AISI 304.
Acier inoxydable AISI 304.
Rostfreier Stahl AISI 304.
Acciaio inossidabile AISI 304.
Aço inoxidável AISI 304.



Plástico técnico PE
Technopolymer PE
Plastique technique PE
Technischer Kunststoff PE
Plastico tecnico PE
Plástico técnico PE



Acrílico.
Acrylic.
Acrylique.
Acryl.
Acrilico.
Acrílico.



Cristal biselado y satinado.
Beveled and satin glass.
Verre biseauté et satiné.
Geschliffener und santinierter Glas.
Cristallo molato satinado.
Vidro satinado com moldura facetada.



Acero inoxidable AISI 202.
Stainless steel AISI 202.
Acier inoxydable AISI 202.
Rostfreier Stahl AISI 202.
Acciaio inossidabile AISI 202.
Aço inoxidável AISI 202.



PMMA transparente.
Transparent PMMA.
PMMA transparent.
Transparenter PMMA.
PMMA transparente.
PMMA transparente.



Acero fundido.
Cast steel.
Acier coulé.
Gussstahl.
Acciaio fuso.
Aço fundido.



Cristal burbuja.
Bubbled glass.
Verre à bulles.
Bläschen im Glas.
Cristallo bolicoso.
Vidro com bolhas.



Acero inoxidable AISI 316.
Stainless steel AISI 316.
Acier inoxydable AISI 316.
Rostfreier Stahl AISI 316.
Acciaio inossidabile AISI 316.
Aço inoxidável AISI 316.



PMMA mate.
Matt PMMA.
PMMA mat.
Matter PMMA.
PMMA matt.
PMMA mate.



Aluminio.
Aluminium.
Aluminium.
Aluminium.
Alluminio.
Alumínio.



Cristal mate.
Matt glass.
Verre mat.
Matter Glas.
Vicchiere matt.
Vidro mate.



Polycarbonato.
Polycarbonate.
Polycarbonate.
Polykarbonat.
Polycarbonate.
Polycarbonato.



Difusor PMMA opal mate.
Satin opal PMMA diffuser.
Diffuseur PMMA opale satiné.
Opal matter PMMA Diffuser.
Diffusore PMMA Opale Matt.
Difusor PMMA opalino satinado.



Aluminio anodizado.
Anodized aluminium.
Aluminium anodisé.
Eloxiertes Aluminium.
Alluminio anodizzato.
Alumínio anodizado.



Cristal opal.
Opal glass.
Verre opal.
Optishes Glas.
Vetro ottico.
Vidro opalino.



Polycarbonato mate.
Matt polycarbonate.
Polycarbonate mat.
Matter Polykarbonat.
Polycarbonato matt.
Polycarbonato mate.



PMMA prismatizado.
Prismatic PMMA.
PMMA prismatique.
Prismatisierter PMMA.
PMMA prismático.
PMMA prismático.



Aluminio extrusionado.
Extruded aluminium.
Extrudé d'aluminium.
Extrudiertes Aluminium
Estruso di alluminio.
Alumínio extrudido.



Cristal prismatizado.
Prismatic glass.
Verre prismatique.
Prismatisierter mit Bläschen im Glas.
Cristallo prismatico.
Vidro prismático.



Polycarbonato opal.
Opal polycarbonate.
Polycarbonate opale.
Opaler Polykarbonat
Polycarbonato Opale.
Polycarbonato opalino.



PMMA transparente.
Transparent PMMA.
PMMA transparent.
Transparenter PMMA.
PMMA transparente.
PMMA transparente.



Aluminio inyectado.
Injected aluminium.
Aluminium injecté.
Spritzaluminium.
Alumínio inyectado.
Alluminio pressofuso.



Cristal rústico.
Rustic glass.
Verre rustique.
Cristallo rustico.
Rustikaler mit Bläschen im Glas
Vidro rústico.



Polycarbonato prismatizado.
Prismatic polycarbonate.
Polycarbonate prismatique.
Prismatisierter Polykarbonat.
Polycarbonato prismatico.
Polycarbonato prismático.



Resina
Resin
Résine
Harz
Resina
Resina sintética



Aluminio de alta pureza.
High purity aluminium.
Aluminium haute pureté.
Aluminium mit hohem Reinheitsgrad.
Alluminio di alta purezza.
Alumínio de elevada pureza.



Difusor de cristal satinado.
Satin glass diffuser.
Diffuseur en verre satiné.
Satinierter Glasdiffusor.
Diffusore di cristallo satinato.
Difusor de vidro satinado.



Polycarbonato satinado.
Satin polycarbonate.
Polycarbonate satiné.
Satinierter Polykarbonat.
Polycarbonate raso.
Polycarbonato satinado.



Tecnopolímero.
Technopolymer.
Technopolymère.
Technopolymer.
Tecnopolímero.
Tecnopolímero.



Cristal.
Glass.
Verre.
Glas.
Vicchiere.
Vidro.



Cristal templado.
Hardened glass.
Verre trempé.
Gehärtetes durchsichtiges Glas.
Bicchiere indurito.
Vidro endurecido.



Polycarbonato transparente.
Transparent polycarbonate.
Polycarbonate transparent.
Transparenter Polykarbonat.
Polycarbonate trasparente.
Polycarbonato transparente.



Termoplástico.
Thermoplastic.
Thermoplastique.
Thermoplastik.
Thermoplastic.
Thermoplástico.



Madera de teca.
Teak wood.
Bois en teck.
Teakholz.
Legno di teak.
Madeira de teca.

SIMBOLOGÍA / SIMBOLS

 Uds. de embalaje Items per box Unité d'emballage Verpackungseinheiten Unità d'imballaggio Uds. de embalagem	 Clase I Class I Classe I Klasse I Classe I Classe I	 Clase II Class II Classe II Klasse II Classe II Classe II	 Clase III Class III Classe III Klasse III Classe III Classe III
--	--	--	--

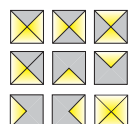
	Dirección del halo de luz. Halo light direction. Direction du faisceau lumineux. Lichtstrom in Richtung Direzziune dall'halo. Direcção do feixe de luz.
---	--

Se aplicará un 3% de descuento a todos los pedidos que respeten las unidades de embalaje.

 Aplique colgado
Pendant wall fixture
Applique suspendue
Pendel Wandeluchte
Applique sospeso
Arandela pendurada

 Plafón
Ceiling fixture
Plafonier
Deckenleuchte
Plafonier
Luminária de tecto

 Sobremuro
Lantern
Lanterne
Mauerleuchte
Lampada di muro
Sobremuro

 Farola
Lamp-post
Lampadaire
Laternenpfahl
Fanale
Luminária

 Aplique adosado
Wall mounted
Applique murale
Einbauwandeluchte
Applique a schiera
Arandela encastada

 Colgante
Pendant
Suspension
Pendelleuchte
Lampada a sospensione
Luminária para suspensão

 Baliza
Beacon
Balise
Stehleuchte
Paletti
Luminária para balizagem

 Empotrable
Embedded
À encastrer
Einbauleuchten
Encastrable
Encastravel

CE Fabricado según las normas de seguridad y electromagnetismo de Europa.
Manufactured according to the set safety and electromagnetism standards of Europe.
Fabriqué selon les normes de sécurité électromagnétiques européennes.
Hergestellt gemäß den europäischen Sicherheitsnormen und Vorschriften für Elektromagnetismus.
Fabbricato secondo le norme di sicurezza elettromagnetica europea.
Fabricado de acordo com as normas europeias de segurança e electromagnetismo.

 Distancia mínima entre el foco de la luminaria y el objeto iluminado.
Minimum distance to be left between the focus of the lighting fixture and the lightened object.
La distance minimum pour être gauche entre le foyer de l'accessoire d'éclairage et l'objet allumé.
Mindestabstand zwischen dem Scheinwerfer der Leuchte und dem beleuchteten Gegenstand.
Distanza minima tras il fuoco della lampada e l'oggetto illuminato.
Distância mínima entre o foco da luminária e o objecto iluminado.

F Instalable sobre una superficie normalmente inflamable.
Suitable for installation on normally inflammable surfaces.
Convient aux installations sur des surfaces normalement inflammables.
Kann auf brennbare Oberflächen installiert werden.
Installabile su superfici normalmente infiammabili.
Pode ser instalado sobre uma superfície normalmente inflamável.

 No instalable sobre una superficie normalmente inflamable.
Unsuitable for installation on normally inflammable surfaces.
Ne pas installer sur des surfaces normalement inflammables.
Darf nicht auf brennbaren Oberflächen installiert werden.
Non installabile su superfici normalmente infiammabili.
Não pode ser instalado sobre uma superfície normalmente inflamável.

 Rotación en el plano vertical de $\pm 90^\circ$
Adjustable $\pm 90^\circ$ on the vertical axis
Inclinaison sur le plan vertical de $\pm 90^\circ$
Einstellbar $\pm 90^\circ$ in der Vertikalachse
Regolazione di $\pm 90^\circ$ nel piano verticale
Rotação no plano vertical $\pm 90^\circ$

 Rotación en el plano horizontal de $\pm 90^\circ$
Adjustable $\pm 90^\circ$ on the horizontal axis
Inclinaison sur le plan horizontal de $\pm 90^\circ$
Einstellbar $\pm 90^\circ$ in der Horizontalachse
Regolazione di $\pm 90^\circ$ nel piano orizzontale
Rotação no plano horizontal $\pm 90^\circ$

 Rotación en el plano vertical de $\pm 45^\circ$
Adjustable $\pm 45^\circ$ on the vertical axis
Inclinaison sur le plan vertical de $\pm 45^\circ$
Einstellbar $\pm 45^\circ$ in der Vertikalachse
Regolazione di $\pm 45^\circ$ nel piano verticale
Rotação no plano vertical $\pm 45^\circ$

 Rotación en el plano horizontal de $\pm 45^\circ$
Adjustable $\pm 45^\circ$ on the horizontal axis
Inclinaison sur le plan horizontal de $\pm 45^\circ$
Einstellbar $\pm 45^\circ$ in der Horizontalachse
Regolazione di $\pm 45^\circ$ nel piano orizzontale
Rotação no plano horizontal $\pm 45^\circ$

 Rotación en el plano vertical de $\pm 15^\circ$
Adjustable $\pm 15^\circ$ on the vertical axis
Inclinaison sur le plan vertical de $\pm 15^\circ$
Einstellbar $\pm 15^\circ$ in der Vertikalachse
Regolazione di $\pm 15^\circ$ nel piano verticale
Rotação no plano vertical $\pm 15^\circ$

 Rotación en el plano horizontal de $\pm 180^\circ$
Adjustable $\pm 180^\circ$ on the horizontal axis
Inclinaison sur le plan horizontal de $\pm 180^\circ$
Einstellbar $\pm 180^\circ$ in der Horizontalachse
Regolazione di $\pm 180^\circ$ nel piano orizzontale
Rotação no plano horizontal $\pm 180^\circ$

 Rotación en el plano horizontal de $\pm 45^\circ$
Adjustable $\pm 45^\circ$ on the horizontal axis
Inclinaison sur le plan horizontal de $\pm 45^\circ$
Einstellbar $\pm 45^\circ$ in der Horizontalachse
Regolazione di $\pm 45^\circ$ nel piano orizzontale
Rotação no plano horizontal $\pm 45^\circ$

 Rotación de 360° alrededor del plano vertical
Adjustable from 0° to 360° on the vertical axis
Inclinaison de 0° à 360° sur le plan vertical
Einstellbar 0° bis 360° in der Vertikalachse
Rotazione a 360° attorno all'asse verticale
Rotação de 360° ao redor do plano vertical

 Rotación en el plano horizontal de $\pm 20^\circ$
Adjustable $\pm 20^\circ$ on the horizontal axis
Inclinaison sur le plan horizontal de $\pm 20^\circ$
Einstellbar $\pm 20^\circ$ in der Horizontalachse
Regolazione di $\pm 20^\circ$ nel piano orizzontale
Rotação no plano horizontal $\pm 20^\circ$

 Rotación de 350° alrededor del plano vertical
Adjustable from 0° to 350° on the vertical axis
Inclinaison de 0° à 350° sur le plan vertical
Einstellbar 0° bis 350° in der Vertikalachse
Rotazione di 350° attorno all'asse verticale
Rotação de 350° ao redor do plano vertical

 Rotación en el plano horizontal de $\pm 120^\circ$
Adjustable $\pm 120^\circ$ on the horizontal axis
Inclinaison sur le plan horizontal de $\pm 120^\circ$
Einstellbar $\pm 120^\circ$ in der Horizontalachse
Regolazione di $\pm 120^\circ$ nel piano orizzontale
Rotação no plano horizontal $\pm 120^\circ$

 Rotación de 355° alrededor del plano vertical
Adjustable from 0° to 355° on the vertical axis
Inclinaison de 0° à 355° sur le plan vertical
Einstellbar 0° bis 355° in der Vertikalachse
Rotazione di 355° attorno all'asse verticale
Rotação de 355° ao redor do plano vertical

SIMBOLOGÍA / SIMBOLS



Ajustable de 0° a 40° en relación al plano horizontal
Adjustable from 0° to 40° on the horizontal axis
Inclinaison de 0 à 40° par rapport au plan horizontal
Einstellbar 0° bis 40° in der Horizontalachse
Regolabile in inclinazione da 0° a 40° rispetto al piano orizzontale
Ajustável de 0° a 40° em relação ao plano horizontal



Ajustable de 0° a 90° en relación al plano horizontal
Adjustable from 0° to 90° on the horizontal axis
Inclinaison de 0 à 90° par rapport au plan horizontal
Einstellbar 0° bis 90° in der Horizontalachse
Regolabile in inclinazione da 0° a 90° rispetto al piano orizzontale
Ajustável de 0° a 90° em relação ao plano horizontal



Possibilità di suministrar con un IP más alto (Complementando con accesorios 71-9405 ó 71-9406)
Higher IP option available (To complement with accessories 71-9405 ó 71-9406)
IP supérieur disponible sur demande (Par ajout d'accessoire 71-9405 ó 71-9406)
Höheres IP möglich nach Anfrage (Andere Zubehör 71-9405 ó 71-9406)
Possibilità di fornitura con IP più alto (Ed anche con degli accessori 71-9405 ó 71-9406)
Possibilidade de fornecer com um IP maior (Complementando com acessórios 71-9405 ó 71-9406)



Caja para empotrar de tecnopolímero incluida
Recessed technopolymer box included
Boîte à encastrer en technopolymère incluse
technopolimer Einbaustufe inklusive
Involucro per l'incasso in tecnopolimero incluso
Caixa para embutir de tecnopolímero incluída



Guía de instalación
Installation guide
Guide d'installation
Einbauanleitung
Guida di installazione
Guia de instalação



No necesita instalación
No installation required
Sans installation nécessaire
Benötigt keine Installation
Non necessita di installazione
Não necessita instalação



Resistente a hilo incandescente a 850°
Resistance to incandescent wire at 850°
Résistance à filament incandescent à 850°
Glühdrähtbeständig auf 850°
Resistente a filo incandescente a 850°
Resistencia a fio incandescente a 850°



Empotrable para paso de vehículos hasta 2.500 Kg. y velocidad 20 Km/h
Built-in lamp vehicle resistant up to 2,500 Kg. and speed 20 Km/h
Encastré pour pas des voitures jusqu'à 2.500 Kg. et vitesse 20 Km/h
Geeignet zum Einbau von Durchfahrten für Fahrzeuge mit einem Gewicht bis zu 2.500 kg und einer Geschwindigkeit von 20km/h
Elemento a incasso resistente a passaggio di veicoli fino a 2.500 Kg. con velocità fino a 20 Km/h
Aparelho para encastrar que resiste ao passo de veículos de até 2500 Kg a uma velocidade de 20 Km/h



Empotrable para zona peatonal
Downlight for pedestrian crossing
Encastré pour zone piétonnière
Einbauleuchte für Fußgängerübergang
Carrabile per zona pedonale
Embutido para zona de pedestres



Temperatura máxima en la superficie de la luminaria
Highest temperature on the surface
Température maximale à la superficie du luminaire
Leuchtenoberfläche max. Temperatur
Temperatura massima alla superficie dell'apparecchio
Temperatura máxima da superfície da luminaria



Accesorio reflector incluido
Reflector accessory included
Accessoire réflecteur compris
Zubehör, Reflektor inklusive
Accessori riflettori incluso
Acessório reflector incluído



Luz orientable
Directional light
Lumière orientable
Ausrichtbares Licht
Luce orientabile
Luz orientável



Estaca de plástico incluida
Plastic spike included
Piquet en plastique inclus
Kunststoff Pfahl inklusive
Palo in plastica incluso
Vara de plástico incluída



Drenaje.
Drainage.
Drainage.
Dränage.
Drenaggio.
Drenagem.



Transformador electrónico integrado
Electronic recessed transformer
Transformateur électronique inclus
Elektronisches Vorschalgerät inklusive
Trasformatore elettronico incluso
Transformador eletrônico incluso



Transformador magnético integrado
Magnetic recessed transformer
Transformateur magnétique inclus
Magnetisches Vorschalgerät inklusive
Trasformatore magnetico incluso
Transformador magnético incluso



Transformador magnético BAG integrado
BAG magnetic recessed transformer
Transformateur magnétique BAG inclus
BAG Magnetisches Vorschalgerät inklusive
Trasformatore magnetico BAG incluso
Transformador magnético BAG incluso



Transformador electrónico Philips integrado
Philips electronic recessed transformer
Transformateur électronique Philips inclus
Philips Elektronisches Vorschalgerät inklusive
Trasformatore elettronico Philips incluso
Transformador eletrônico Philips incluso



Transformador electrónico Vossloh integrado
Vossloh electronic recessed transformer.
Transformateur électronique Vossloh inclus
Vossloh Elektronisches Vorschalgerät inklusive
Trasformatore elettronico Vossloh incluso
Transformador eletrônico Vossloh incluso



Cristal de recambio de cortesía
Courtesy spare glass included
Verre rechange compris
Zusätzliche Ersatzteile aus Glas zum Auswechsein
Cristallo di ricambio omaggio
Vidro de reposto incluído



x metros de cable.
x meters of cable.
x metre de câble.
x Meter langes Kabel.
x metri di cabo.
x metros de cabo.



Bajo consumo
Energy saving
Économie d'énergie
Energiesparlampe
Risparmio energetico
Baixo consumo



(s) Consultar disponibilidad
Consult availability
Consulter disponibilités
Verfügbarkeit abfragen
Consultare disponibilità
Consultar disponibilidade

<40°C

Temperatura en la superficie menor de 40°C
Temperature on the surface under 40°C
Température à la surface inférieure à 40°C
Oberflächentemperatur unter 40°C
Temperatura alla superficie minore di 40 °C
Temperatura na superfície inferior a 40°C

40-80°C

Temperatura en la superficie entre 40 y 80°C
Temperature on the surface between 40 and 80°C
Température à la surface comprise entre 40 et 80°C
Oberflächentemperatur zwischen 40 und 80°C
Temperatura alla superficie tra 40 e 80 °C
Temperatura na superfície entre 40 e 80°C

>80°C

Temperatura en la superficie superior a 80°C
Temperature on the surface over 80°C
Température à la surface supérieure à 80°C
Oberflächentemperatur über 80°C
Temperatura alla superficie superiore di 80 °C
Temperatura na superfície superior a 80°C

Sistema de codificación para indicar el grado de protección proporcionado por una envolvente contra la entrada de elementos sólidos y líquidos.

A coding system that shows the degree of protection that a casing provides against the penetration of solid objects or dust and liquids.

Système de codification permettant d'indiquer le degré de protection procuré par une enveloppe contre la pénétration de corps solides, poussières et liquides.

Sistema di codifica per indicare il grado di protezione offerto da un involucro contro la penetrazione di oggetti solidi, di polvere, o di liquidi.

Dieses Codierungssystem dient zur Angabe des Schutzgrades, der mit einer besonderen Verkleidung zum Schutz gegen das Eindringen fester Gegenstände, Staub oder Flüssigkeiten erreicht wird.

Sistema de codificação para a indicação do grau de protecção proporcionado por um invólucro contra a penetração de objectos sólidos ou pó e líquidos.

 **IP 23** Lámpara protegida contra la penetración de objetos sólidos mayores de 12mm y contra el agua en forma de lluvia hasta 60° de inclinación.
Lamp protected against ingress of solid objects greater than 12mm and against spraying water.
Luminaire protégé contre la pénétration d'objets solides d'une taille supérieure à 12mm, et contre l'eau de pluie inclinée à plus de 60°.
Lampe geschützt gegen das Eindringen von festen Gegenständen, die größer als 12 mm sind und gegen Regenwasser mit einer Inklination bis zu 60°.
Lampada protetta dalla penetrazione di oggetti solidi più grandi di 12 mm e dell'acqua piovana con inclinazione fino a 60°.
Luminária protegida contra a penetração de objectos sólidos >12mm e contra a penetração de água em forma de chuva até uma inclinação de 60°.

 **IP 44** Lámpara protegida contra la penetración de objetos sólidos mayores de 1mm y contra proyecciones de agua en todas direcciones.
Lamp protected against ingress of solid objects greater than 1mm and against splashing water.
Luminaire protégé contre la pénétration d'objets solides d'une taille supérieure à 1mm, et contre les projections d'eau dans toutes les directions.
Lampe geschützt gegen das Eindringen von festen Gegenständen, die größer als 1 mm und gegen Wasserstrahlen aus allen Richtungen.
Lampada protetta dalla penetrazione di oggetti solidi più grandi di 1 mm e dagli schizzi d'acqua provenienti da tutte le direzioni.
Luminária protegida contra a penetração de objectos sólidos >1mm e contra projecções de água em todas as direcções.

 **IP 45** Lámpara protegida contra la penetración de objetos sólidos mayores de 1mm y contra chorros de agua en todas direcciones.
Lamp protected against ingress of solid objects greater than 1mm and against water jets.
Luminaire protégé contre la pénétration d'objets solides d'une taille supérieure à 1mm et contre jets d'eau.
Lampe geschützt gegen das Eindringen von festen Gegenständen, die größer als 1 mm und gegen Wassergüsse aus allen Richtungen.
Lampada protetta dalla penetrazione di oggetti solidi più grandi di 1 mm e dai getti d'acqua provenienti da tutte le direzioni.
Luminária protegida contra a penetração de objectos sólidos >1mm e contra os jactos de água em todas as direcções.

 **IP 54** Lámpara protegida contra la penetración de polvo y contra proyecciones de agua en todas direcciones.
Lamp protected against ingress of dust and against splashing water.
Luminaire protégé contre les poussières et contre les projections d'eau dans toutes les directions.
Lampe geschützt gegen das Eindringen von Staub und gegen Wasserstrahlen aus allen Richtungen.
Lampada a prova di polvere e di schizzi d'acqua provenienti da tutte le direzioni.
Luminária protegida contra a penetração de pó e contra projecções de água em todas as direcções.

 **IP 55** Lámpara protegida contra la penetración de polvo y contra chorros de agua en todas direcciones.
Lamp protected against ingress of dust and water jets.
Pièce protégée contre la poussière et jets d'eau.
Lampe geschützt gegen das Eindringen von Staub und gegen Wassergüsse aus allen Richtungen.
Lampada a prova di polvere e di getti d'acqua provenienti da tutte le direzioni.
Luminária protegida contra a penetração de pó e contra os jactos de água em todas as direcções.

 **IP 65** Lámpara totalmente protegida contra la penetración de polvo y contra chorros de agua en todas direcciones.
Dust-tight lamp, protected against water jets.
Luminaire totalement protégé contre les poussières et les jets d'eau dans toutes les directions.
Lampe vollkommen geschützt gegen das Eindringen von Staub und gegen Wassergüsse aus allen Richtungen.
Lampada a prova di polvere e di getti d'acqua provenienti da tutte le direzioni.
Luminária protegida contra a penetração de pó e contra jactos de água em todas as direcções.

 **IP 66** Lámpara totalmente protegida contra la penetración de polvo y contra las pulverizaciones de agua con una presión de 1 bar a 3 metros.
Dust-tight lamp, protected against water jets and against water spray at a pressure of 1 bar at three metres.
Luminaire totalement protégé contre les poussières et les jets d'eau dans toutes les directions et les pulvérisations d'eau à une pression de 1 bar à trois mètres.
Lampe vollkommen geschützt gegen das Eindringen von Staub und gegen Wasserbestäubung mit einem Druck bis zu 1 bar aus 3 Meter Entfernung.
Lampada a prova di polvere e protetta dalle polverizzazioni d'acqua a pressione di 3 bar a distanza di 3 metri.
Luminária protegida contra a penetração de pó e contra as pulverizações de água com uma pressão de 1 bar a três metros

 **IP 67** Lámpara totalmente protegida contra la penetración de polvo y contra los efectos de la inmersión.
Dust-tight lamp, protected against immersion.
Pièce protégée contre la poussière et immersion.
Lampe vollkommen geschützt gegen das Eindringen von Staub und gegen die Auswirkungen von Immersion im Wasser.
Lampada a prova di polvere e di immersione.
Luminária hermética contra a penetração de pó e resistente à imersão temporal.

 **IP 68 ... m** Lámpara totalmente protegida contra el polvo, protección contra los efectos de la inmersión prolongada en agua y en profundidad.
Dust-tight lamp and protected against the effects of prolonged immersion in water and at depth.
Luminaire totalement protégé contre les poussières et contre les effets de l'immersion prolongée dans l'eau et en profondeur.
Lampe vollkommen geschützt gegen das Eindringen von Staub und gegen Staub und gegen die Auswirkungen von lang andauernder Immersion im tiefen Wasser.
Lampada a prova di polvere e resistente all'immersione prolungata in acqua, anche in profondità.
Luminária completamente protegida contra o pó e contra os efeitos da imersão prolongada em água a profundidade.

IK

IK01: 0,15J
IK02: 0,20J
IK03: 0,35J
IK04: 0,5J
IK05: 0,7J
IK06: 1J
IK07: 2J
IK08: 5J
IK09: 10J
IK010: 20J

Código IK

Sistema de codificación para indicar el grado de protección proporcionado por una envolvente contra los impactos mecánicos nocivos.
Energía de impacto (Jules)

IK Code

It is a coding system that shows the level of protection that a casing provides against damaging mechanical impacts.
Energy of impact (Jules)

Code IK

Système de codification permettant d'indiquer le degré de protection procuré par une enveloppe contre les impacts mécaniques nuisibles.
Energie d'impact (en Joules)

IK Schutzklasse

Dieses Codierungssystem dient zur Angabe des Schutzgrades, der mit einer besonderen Verkleidung zum Schutz gegen schädliche mechanische Einflüsse erreicht wird.
Schlagenergie (Joule)

Codice IK

Sistema di codifica per indicare il grado di protezione offerto da un involucro contro gli impatti meccanici dannosi.
Energia di impatto (Joule).

Código IK

Sistema de codificação para indicar o grau de protecção proporcionado por um invólucro contra os impactos mecánicos nocivos.
Energia de impacto (Jules)

EMPOTRABLES DE TIERRA – DRENAJE

Es imprescindible seguir las instrucciones de montaje y la guía de instalación de los empotrables para lograr el mejor funcionamiento posible de la luminaria.

1. Evitar colocar las luminarias en zonas de depresión del terreno.
2. Evitar colocar las luminarias en zonas donde se pueda acumular agua y en ubicaciones permanentemente húmedas, como jardines o césped.
3. Evitar el uso de productos químicos utilizados para el abono de jardines ya que pueden deteriorar algunos componentes.
4. Nivelar la luminaria con el pavimento.
5. Prever un recubrimiento de dilatación en el caso de empotrables colocados en superficies como el cemento o el hormigón para evitar la posible dilatación o compresión.
6. Colocar un drenaje eficaz para evitar el estancamiento de agua, como mínimo de 25 centímetros de grava por debajo de la carcasa de instalación. Un drenaje correcto debe absorber hasta 10 litros de agua en 15 minutos.
7. Hacer funcionar la luminaria durante 20 minutos sin el cristal para evitar condensaciones de agua dentro.

BUILT-IN FLOOR LUMINAIRES - DRAINAGE

It is essential to follow the assembling instructions and the installation guide of the built-in luminaires in order to achieve the best performance.

1. Avoid installing the luminaires in terrain depressions.
2. Avoid installing the luminaires in areas where water can accumulate and in places that are permanently damp, such as gardens or lawns.
3. Avoid the use of chemical products used to fertilise gardens because they could damage some of the components.
4. Level the luminaire with the surface.
5. Anticipate a dilation coating for built-in luminaires installed on surfaces like cement or concrete, to avoid possible dilation or compression.
6. Install an effective drainage system to avoid the accumulation of water, at least 25 cm of gravel under the installation casing. A correct drainage must absorb up to 10 litres of water in 15 minutes.
7. Put the light on for 20 minutes without the glass to avoid condensation inside.

ENCASTRABLES AU SOL – DRAINAGE

Il est indispensable de suivre les instructions et le guide d'installation des encastrables afin de garantir un éclairage optimum.

1. Éviter l'installation de luminaires dans des zones de dépression de terrain.
2. Éviter l'installation de luminaires dans des espaces où s'accumule de l'eau ou des zones humides telles que jardins ou pelouses.
3. Éviter l'utilisation de produits chimiques utilisés pour le compostage des jardins car ils peuvent détériorer certains composants.
4. Nivelier le terrain en vue de l'installation des luminaires.
5. Prévoir un recouvrement pour la dilatation dans le cas de luminaires encastrables installés en surface tel que le ciment ou le béton, afin d'éviter une possible dilatation ou compression.
6. Poser un drain efficace afin d'éviter toute stagnation de l'eau, avec un minimum de 25 centimètres de gravier en dessous de l'installation. Un drain efficace doit permettre d'absorber jusqu'à 10 litres d'eau en 15 minutes.
7. Faire fonctionner le luminaire pendant 20 minutes, sans le verre, afin d'éviter toute condensation d'eau à l'intérieur.

ELEMENTI DA INCASSARE AL SUOLO – DRENAGGIO

È indispensabile seguire le istruzioni di montaggio e la guida di installazione degli elementi a incasso per ottenere il migliore funzionamento possibile della luminaria.

1. Evitare di collocare le luminarie in zone depresse del terreno.
2. Evitare di collocare le luminarie in zone in cui possa accumularsi acqua e in ubicazioni permanentemente umide, come giardini o prati.
3. Evitare l'uso di prodotti chimici utilizzati per la concimazione di giardini, dal momento che potrebbero deteriorare alcuni componenti.
4. Collocare la luminaria a livello del suolo.
5. Prevedere un rivestimento di dilatazione nel caso di elementi a incasso collocati in superfici come cemento e calcestruzzo, per evitare la possibile dilatazione o compressione.
6. Disporre un drenaggio efficace per evitare il ristagno di acqua, come minimo di 25 centimetri di ghiaia al di sotto della carcassa di installazione. Un drenaggio corretto deve assorbire fino a 10 litri di acqua in 15 minuti.
7. Far funzionare la luminaria per 20 minuti senza il cristallo per evitare la condensa di acqua al suo interno.

BODENEINBAULEUCHTEN – DRAINAGE

Die Montageanweisungen und Anleitungen des Handbuchs für die Installation der Bodeneinbauleuchten sind unbedingt zu befolgen, um den bestmöglichen Betrieb der Beleuchtungskörper gewährleisten zu können.

1. Vermeiden Sie die Montage der Beleuchtungskörper in abschüssigem Gelände.
2. Vermeiden Sie die Montage der Beleuchtungskörper in Bereichen der Wasseransammlung und in Feuchtzonen, wie Gärten und Rasenflächen.
3. Vermeiden Sie die Verwendung von chemischen Gartendüngemitteln, da diese einen schädlichen Einfluss auf einige der Komponenten ausüben können.
4. Bringen Sie den Beleuchtungskörper und den Bodenbelag auf eine Höhe.
5. Sorgen Sie beim Einbau der Beleuchtungskörper in Zement- oder Betonflächen für eine geeignete Ummantelung, um eine eventuelle Ausdehnung oder ein Zusammenpressen zu verhindern.
6. Bauen Sie ein wirksames Drainagesystem ein, um das Anstauen von Wasser zu vermeiden, wobei ein Kiesbett von mindestens 25 cm unter dem Einbaugeschäube vorhanden sein muss. Bei einer korrekten Drainage müssen bis zu 10 Liter Wasser in 15 Minuten absorbiert werden.
7. Nehmen Sie den Beleuchtungskörper 20 Minuten lang ohne Deckglas in Betrieb, um eine Kondensierung des Wassers im Inneren der Leuchte zu vermeiden.

ENCASTRÁVEIS DE TERRA – DRENAGEM

É imprescindível que siga as instruções de montagem e o guia de instalação dos encastráveis para obter o melhor funcionamento possível do aparelho de iluminação.

1. Evite colocar os aparelhos de iluminação em zonas de depressão do terreno.
2. Evite Coloque os aparelhos de iluminação em zonas onde se possa acumular água e em localizações permanentemente húmidas, como jardins ou relva.
3. Evite o uso de produtos químicos utilizados para o adubamento de jardins, dado que eles podem deteriorar alguns componentes.
4. Nivele o aparelho de iluminação pelo pavimento.
5. Preveja um revestimento de dilatação no caso de encastráveis colocados em superfícies como o cimento ou o betão para evitar a eventual dilatação ou compressão.
6. Coloque uma drenagem eficaz para evitar a estagnação da água, no mínimo de 25 centímetros de gralilha abaixo da carcaça de instalação. Uma drenagem correcta deve absorver até 10 litros de água em 15 minutos.
7. Faça funcionar o aparelho de iluminação durante 20 minutos sem o vidro para evitar condensações de água dentro dele.



DIRECTIVA SOBRE APARATOS ELÉCTRICOS Y ELECTRÓNICOS (RAEE)

El cargo RAEE consiste en un ingreso para financiar la gestión de los Residuos de Aparatos Eléctricos y Electrónicos (RAEE) a nivel nacional. No es ningún impuesto o tasa, sino un coste inherente a la gestión de residuos que deberá ser mostrado a los consumidores de forma separada en el momento de la venta.

Según el Real Decreto 2008/2005, el cargo RAEE deberá aparecer en los documentos de venta, así como en las facturas emitidas por el fabricante, y repercutidas posteriormente por el usuario final, ya sea instalador o distribuidor.

Hasta el 13 de febrero de 2011 deberá aparecer de manera separada, es decir, diferenciando el precio de la RAEE. A partir del 13 de febrero de 2011 formará parte integrante del precio, sin tener que desglosar este importe.

La Legislación Española con el R.D. 208//200/ (RAEE) establece tres categorías distintas de cargos RAEE en función de los pesos de los aparatos:

- Categoría A: <900 gr. - 0,25€/unidad
- Categoría B: de 900 gr. hasta 6Kg. - 0,56€/unidad
- Categoría C: >6Kg - 0,73€/unidad

El cargo RAEE no es de aplicación sobre partes de luminarias, ya sean recambios o componentes, sino solo sobre luminarias completas. En caso de suministrar lámparas fluorescentes en los aparatos, se repercutirá un cargo RAEE de 0,30€/unidad adicional, independientemente de la potencia de la lámpara en cuestión.

En el caso de las exportaciones, cada país tiene su propia directiva y establece las características del cargo.

ELECTRICAL AND ELECTRONIC EQUIPMENT DIRECTIVE (WEEE)

The WEEE charge is an amount of money to pay for the management of Waste Electrical and Electronic Equipment (WEEE), nationally. It is not tax or a fee; it is an inherent cost in waste management that has to be shown to consumers separately when they buy the product.

In accordance with the ROYAL DECREE 2008/2005, the WEEE charge must appear on sales documents, as well as on invoices issued by the manufacturer, and passed on to the final user, either the installer or the distributor.

The WEEE cost must appear separately until 13 February 2011. From 13 February 2011 onwards it will be part of the price and there will be no need to break down the price.

Spanish legislation, with the ROYAL DECREE 208//200/ (WEEE) establishes three different categories of WEEE charges according to the weight of the equipment:

- Category A: <900 gr. - 0.25€/unit
- Category B: 900 gr. up to 6 kg. - 0.56€/unit
- Category C: >6 kg. - 0.73€/unit

The WEEE charge does not apply to luminaire spare parts or pieces; only to full luminaires. If the luminaires are supplied with fluorescent lamps, an extra WEEE charge will be added, 0.30€/unidad, regardless of the power of the lamp that is supplied.

In the case of exports, each country has its own directive and establishes the characteristics of the charge.

LA DIRECTIVE SUR LES DECHETS DES EQUIPEMENTS ELECTRIQUES ET ELECTRONIQUES (DEEE)

La contribution environnementale DEEE permet de financer la gestion des Déchets des Equipements Electriques et Electroniques (DEEE) au niveau national. Il ne s'agit ni d'un impôt ni d'une taxe mais d'un montant inhérent à la gestion des déchets qui doit être indiqué aux consommateurs de façon séparée, au moment de la vente.

Selon le Décret royal n° 2008/2005, la contribution DEEE doit figurer sur les documents de ventes, ainsi que sur les factures émises par le fabricant, et répercutée ultérieurement sur l'utilisateur final, soit l'installateur soit le distributeur.

Jusqu'au 13 février 2011, elle devra apparaître, de façon séparée, c'est-à-dire, qu'elle n'est pas incluse dans le prix de l'équipement. A partir du 13 février 2011, cette éco-contribution fera partie intégrante du prix du produit et son montant ne devra pas être détaillé.

Au travers du Décret royal n° 208//200/ (DEEE), la législation espagnole définit trois catégories distinctes de contributions DEEE, en fonction du poids des équipements:

- Catégorie A: <900 gr. - 0,25€/unité
- Catégorie B: de 900gr. jusqu'à 6Kg. - 0,56€/unité
- Catégorie C: >6Kg. - 0,73€/unité

La contribution environnementale DEEE ne s'applique pas aux pièces de luminaires telles que pièces de rechange ou composants mais aux luminaires dans leur ensemble. Si les équipements utilisent des lampes fluorescentes, une contribution environnementale DEEE supplémentaire de 0,30€/unité sera ajoutée, indépendamment de la puissance de la lampe en question.

Dans le cas des exportations, chaque pays dispose de sa propre directive et établit les caractéristiques de la contribution.

DIRETTIVA SULLE APPARECCHIATURE ELETTRICHE ED ELETTRONICHE (RAEE)

L'importo RAEE consiste in un versamento destinato a finanziare lo smaltimento dei Rifiuti di Apparecchiature Elettriche ed Elettroniche (RAEE) a livello nazionale. Non si tratta di un'imposta o tassa, ma di un costo relativo alla gestione dei rifiuti che dovrà essere presentato ai consumatori in modo separato all'atto della vendita.

Secondo il Reale Decreto 2008/2005, l'importo RAEE dovrà apparire nei documenti di vendita, nonché nelle fatture emesse dal fabbricante, per ricadere in ultimo sull'utilizzatore finale, tramite le fatture dell'installatore o distributore.

Fino al 13 febbraio del 2011 dovrà figurare in modo separato, vale a dire la RAEE dovrà essere differenziata dal prezzo in quanto tale. A partire dal 13 febbraio 2011 costituirà parte integrante del prezzo, senza dover scorporare questo importo.

La Legislazione Spagnola con il R.D. 208//200/ (RAEE) stabilisce tre categorie distinte di addebiti RAEE in funzione dei pesi degli apparati:

- Categoria A: <900gr. - 0,25€/unità
- Categoria B: da 900gr. a 6Kg. - 0,56€/unità
- Categoria C: >6Kg. - 0,73€/unità

L'addebito RAEE non viene applicato su parti di luminarie, come ricambi o componenti, ma solo sulle luminarie complete. Nel caso in cui gli apparati siano dotati di lampade fluorescenti, si avrà un addebito RAEE di 0,30€/unità addizionale, indipendentemente dalla potenza della lampada in questione. In caso di esportazione, ciascun paese ha le proprie direttive e stabilisce le caratteristiche dell'addebito.

RICHTLINIE ÜBER ELEKTRO- UND ELEKTRONIK-ALTGERÄTE (WEEE)

Die WEEE-Gebühr ist ein Betrag, der auf nationaler Ebene zur Beseitigung der Abfälle aus elektrischen und elektronischen Geräten eingehoben wird. Dabei handelt es sich nicht um eine Steuer oder öffentliche Abgabe, sondern um die Belastung des Verbrauchers mit den Kosten, die aufgrund der Beseitigung der Abfälle entstehen. Dieser Betrag muss dem Konsumenten zum Zeitpunkt des Verkaufs in getrennter Form aufgezeigt werden.

Nach der Königlichen Verordnung 2008/2005 muss die WEEE-Gebühr in den Verkaufsdokumenten aufscheinen und ebenso in den vom Hersteller ausgestellten Rechnungen. Die entsprechende Gebühr wird später dem Endverbraucher, d.h. dem Einbautechniker oder Vertreiber, in Rechnung gestellt.

Bis zum 13. Februar 2011 ist die WEEE-Gebühr als vom Preis getrennter Betrag anzugeben. Ab dem 13. Februar 2011 wird sie einen integrierten Bestandteil des Preises bilden und muss nicht mehr als getrennter Betrag aufgeschlüsselt werden.

Die spanische Gesetzgebung unterscheidet in der Königlichen Verordnung 208//200/ (WEEE) drei WEEE-Gebührenkategorien, die sich nach dem Gewicht der Geräte richten:

- Kategorie A: <900gr. - 0,25€/Einheit
- Kategorie B: von 900gr. bis 6kg. - 0,56€/Einheit
- Kategorie C: >6kg. - 0,73€/Einheit

Die WEEE-Gebühr ist nicht auf einzelne Bestandteile der Leuchten anzuwenden, weder auf Ersatzteile noch auf Komponenten derselben, sondern nur auf vollständige Leuchten. Bei der Lieferung von Geräten mit Leuchtstoffröhren wird eine zusätzliche WEEE-Gebühr von 0,30€/Einheit eingehoben, und zwar unabhängig von der Leistung der betreffenden Lampe.

Im Exportfall wendet jedes Land seine eigenen Richtlinien an und legt die Bestimmungen bezüglich der Gebührenerhebung fest.

DIRETTIVA SOBRE APARELHOS ELÉCTRICOS E ELECTRÓNICOS (RAEE)

O encargo RAEE consiste numa receita para financiar a gestão dos Resíduos de Aparelhos Eléctricos e Electrónicos (RAEE) a nível nacional. Não é nenhum qualquer ou taxa, mas sim um custo inerente à gestão de resíduos que deverá ser mostrado aos consumidores de forma separada no momento da venda.

De acordo com o Real Decreto 2008/2005, o encargo RAEE deverá constar nos documentos de venda, assim como nas facturas emitidas pelo fabricante, e repercutidas posteriormente no utilizador final, quer instalador quer distribuidor.

Até 13 de Fevereiro de 2011, deverá constar em separado, isto é, diferenciando o preço do RAEE. A partir de 13 de Fevereiro de 2011 fará parte integrante do preço, sem que seja necessário desdobrar este montante.

A Legislação Espanhola com o R.D. 208//200/(RAEE) estabelece três categorias diferentes de encargos RAEE, em função dos pesos dos aparelhos:

- Categoria A: <900gr - 0,25€/unidade
- Categoria B: de 900gr Até 6Kg - 0,56€/unidade
- Categoria C: >6Kg - 0,73€/unidade

O encargo RAEE não é aplicável a partes de aparelhos de iluminação, tanto sobressalentes como componentes, mas apenas a aparelhos de iluminação completas. No caso de fornecimento de lâmpadas fluorescentes nos aparelhos, far-se-á repercutir um encargo RAEE de 0,30€/unidade adicional, independentemente da potência da lâmpada em questão.

No caso das exportações, cada país tem a sua própria directiva e estabelece as características do encargo.

INFORMACIÓN CATÁLOGO

Las descripciones y medidas de los modelos del presente catálogo son orientativas, pudiendo por tanto ser modificadas, a fin de mejorar las características técnicas o de diseño.

Medidas en cm.

La empresa se reserva el derecho de anular o modificar cualquier modelo sin previo aviso.

Todos los modelos presentados cumplen las normas exigidas por la C.E. para aparatos de iluminación de uso doméstico y sus características vienen determinadas por las clases I y II.

Los acabados y las especificaciones técnicas corresponden a los productos que se suministran en Europa, pudiendo éstos variar en otros mercados.

Para una buena conservación de las luminarias, no usar lámparas de potencia superior a las recomendadas y limpiar simplemente con un paño seco. No usar limpiametales, ya que dañan los barnices protectores que garantizan la duración del acabado.

Se recomienda no mojar las luminarias con agua de riego que contenga un grado elevado de sales o ácidos.

Las potencias de las bombillas PL electrónicas E-27 indicadas corresponden a las marcas Osram, Phillips o GE indistintamente, salvo que se especifique una marca en concreto.

CATALOGUE INFORMATION

All descriptions and sizes included in this catalogue are orientative and can be modified due to technical or design reasons.

Any fixture can be withdrawn or modified without previous announcement.

All the fixtures shown in this catalogue follow the EC regulations for decorative lighting under classes I and II.

Measurements in cm.

Finishes and technical specifications are valid only for European market, and can be changed to suit other market requirements.

Do not use bulbs over maximum recommended wattage. Clean with a dry piece of soft fabric. To avoid varnish damage do not use abrasive materials.

It is recommended not to wet the luminaires with water with high salt or acid content.

The wattage indicated for PL electronic E-27 correspond to either Osram, Phillips or GE brands, except where a brand is specifically stated.

INFORMATION CATALOGUE

Toutes les descriptions et dimensions incluses dans ce catalogue sont données à titre indicatif, et peuvent être modifiées pour des raisons techniques ou esthétiques.

Dimensions en centimètres.

N'importe quel modèle peut être supprimé ou modifié sans préavis.

Tous les modèles de ce catalogue sont conformes à la norme C.E. pour les luminaires décoratifs de classe I et II.

Les finitions et spécifications techniques sont valables seulement pour le marché Européen, et peuvent être modifiées pour convenir aux exigences d'autres marchés.

Ne pas utiliser d'ampoule d'une puissance supérieure au maximum recommandé.

Nettoyer avec un chiffon doux et sec. Pour éviter d'abîmer le vernis, ne pas utiliser de produit abrasif.

Est recommandable ne pas mouiller les lumières avec de l'eau contenant un haut degré de sels ou acides.

Les puissances indiquées pour les lampes PL électroniques E27 correspondent indifféremment aux marques Osram, Phillips, ou GE, sauf exception.

KATALOG INFORMATIONEN

Die Beschreibungen und angegebenen Maße von den Modellen des vorliegenden Kataloges dienen lediglich zur Orientierung und können deshalb zur Verbesserung der technischen Charakteristiken oder des Designs modifiziert werden.

Maßangaben in cm.

Das Unternehmen behält sich das Recht vor jegliches Modell ohne vorherige Benachrichtigung zu annullieren oder zu modifizieren.

Alle Modelle erfüllen die von der EG vorgeschriebenen Regelungen von Beleuchtungsapparaten für den Haushaltsgebrauch und die notwendigen Charakteristiken werden von den Produktklassen I und II bestimmt.

Die Fertigverarbeitung und die technischen Spezifizierungen beziehen sich auf die in Europa vertriebenen Produkte; auf den Märkten von anderen Ländern können diese unterschiedlich sein.

Zur guten Erhaltung der Beleuchtungsanlagen sollten keine Lampen (Glühbirnen) verwendet werden, die die empfohlene Stärke übersteigen. Außerdem sollte man keine Metallreiniger benutzen, sondern sie nur mit einem trockenen Tuch säubern, da sonst der Schutzlack beschädigt werden könnte, der die Haltbarkeit der Endverarbeitung garantiert.

Es wird empfohlen die Leuchten nicht mit Gießwasser, das einen hohen Grad an Salz oder Säuren enthalten könnte, zu bespritzen.

Die Stromstärke der elektrischen PL Glühbirnen E-27 ist unterschiedslos für die Produktmarken von Osram, Philips oder Ge angegeben, außer es wird ausdrücklich eine andere Marke verlangt.

INFORMAZIONE CATALOGO

Tutte le descrizioni e le misure sono descritte in questo catalogo, ma possono essere modificate su richiesta specifica per un progetto.

Le misurazioni in centimetri.

Tutte le lampade sono a norma CE e quelle decorative in classe I-II.

Le descrizioni sono valide solo per il mercato europeo, ma possono essere variate per soddisfare altre richieste di mercato.

Non usare lampadine sopra la potenza (W) indicata.

Pulire con panno di tessuto morbido. Per evitare danni alla verniciatura non usare materiali abrasivi.

Si raccomanda non bagnare le lampade con dell'acqua con un alto grado di sali ed acidi.

La potenza indicata per PL elettronico o E27, corrispondente a Osram Philips GE senza distinzione di marchio ad eccezione dove il marchio è specificatamente dichiarato.

INFORMAÇÃO CATÁLOGO

As descrições e medidas dos modelos do presente catálogo são orientativas podendo, portanto, ser modificadas com o fim de melhorar as características técnicas ou de desenho.

Medidas em cm.

LEDS reserva-se o direito de anular ou modificar qualquer modelo sem aviso prévio.

Todos os modelos apresentados cumprem as normas CE para aparelhos de iluminação de uso doméstico e as suas características de protecção estão definidas pelas Classes I ou II.

Para uma boa conservação dos aparelhos, nunca usar lâmpadas de potência superior à recomendada nem usar produtos para limpeza de metais porque podem danificar os vernizes de protecção que garantem a duração do acabamento. Para limpeza usar apenas um pano seco.

Recomenda-se não molhar as luminárias com água de rega que contenha um elevado grau de sais ou ácidos.

As potencias indicadas para as lâmpadas PL electrónicas correspondem às marcas Osram, Phillips ou GE indistintamente, excepto se se especifica alguma marca em concreto.

Todos los derechos reservados. Ninguna parte de este libro puede ser reproducida en ningún formato de papel o electrónico, sin el consentimiento previo del editor o de los propietarios de los derechos.

All rights reserved. No part of this publication may be reproduced or transmitted in any form or by any means, electronic storage and retrieval system, without permission in writing from the copyright owner (s).

Tous droits réservés. Aucune partie de ce livre ne pourra être reproduite en format papier ou électronique sans l'autorisation préalable de l'éditeur ou du propriétaire des droits.

Sämtliche Rechte vorbehalten. Kein Teil dieses Buches darf in keinem Papier- oder elektronischem Format ohne ausdrückliche Zustimmung des Herausgebers oder der Inhaber der Urheberrechte wiedergegeben oder vervielfältigt werden.

Tutti i diritti riservati. Nessuna parte di questo libro può essere riprodotta in nessun formato cartaceo o elettronico, senza la previa autorizzazione dell' editore o dei proprietari dei diritti.

Todos os direitos reservados. Nenhuma parte deste livro pode ser reproduzida em qualquer formato de papel ou electrónico, sem o consentimento prévio do editor ou dos proprietários dos direitos.

TABLA DE RESISTENCIA A LA CORROSIÓN ACERO INOXIDABLE
 CORROSION RESISTANCE TABLE OF STAINLESS STEEL
 TABLEAU DE RÉSISTANCE À LA CORROSION DE L'ACIER INOXYDABLE
 KORROSIONSFESTE PLATTE AUS ROSTFREIEM STAHL
 TABOLA DI RESISTENZA ALLA CORROSIONE DELL'ACCIAIO
 TABELA DE RESISTÊNCIA À CORROSÃO DO AÇO INOXIDÁVEL

	AISI 202	AISI 304	AISI 316
Agua doméstica Domestic water Eau ménagère Haushaltswasser Acqua domestica Água doméstica	OK	OK	OK
Agua doméstica conteniendo cloro Domestic water containing chloride Eau ménagère contenant du chlore Chlorenhaltendes Haushaltswasser Acqua domestica contenente di cloro Água doméstica contendo cloro	X	X	OK
Agua de mar Sea water Eau de mer Meerwasser Acqua di mare Água do mar	X	X	OK
Aire Air Air Luft Aria Ar	OK	OK	OK
Atmósfera marina Marine atmosphere Atmosphère marine Meeresatmosphäre Atmosfera marina Atmosfera marinha	X	X	OK

	AISI 202	AISI 304	AISI 316
Vapor de agua Water vapor Vapeur d'eau Wasserdampf Vapore di acqua Vapor de água	OK	OK	OK
Limpiadores químicos quita cemento Chemical cleaning for use on cement Nettoyeurs chimiques lève ciment Chemische Reiniger zur Zemententfernung Prodotti chimici di pulizia per togliere il cemento Limpadores químicos para a remoção de cimento	X	X	X
Suelos con un PH alto o alcalinos Floors with high PH or alkaline values Terres avec un pH haut ou alcalins Böden mit hohem PH-Wert oder alkalische Böden Pavimenti con alto PH ed alcalini Terrenos com um PH alto ou alcalinos	X	X	OK
Fertilizantes y abonos químicos Fertilizers and chemical fertilizers Fertilisants et engrais chimiques Düngemittel und chemische Dünger Fertilizzante e prodotti chimici Fertilizantes e adubos químicos	X	X	OK

LIMPIEZA Y MANTENIMIENTO DEL ACERO INOXIDABLE

Por su excelente resistencia y belleza, el acero inoxidable es un material de fácil conservación, tendiéndose a tener la errónea idea de que no requiere mantenimiento. Pero es necesario seguir unas recomendaciones mínimas durante su almacenamiento, manipulación y uso. Una limpieza adecuada permite mantener inalteradas sus características originales, preservando su resistencia a la corrosión y apariencia. Durante las tareas de limpieza, asegurar que se eliminan las acumulaciones de contaminantes llevados por el aire. Esto es muy importante en lugares industriales o marítimos ya que pueden provocar corrosión localizada si no se eliminan eficazmente. Para eliminar la suciedad sobre la superficie, se debe utilizar un paño húmedo o una gamuza. En caso de suciedad más difícil, utilizar detergentes suaves de uso doméstico con estropajos o cepillos suaves de nylon (no usar estropajos de acero). Después de limpiar, elimine los residuos con agua desionizada y seque la superficie. La frecuencia para una limpieza regular es de 6-12 meses para una suciedad moderada y de 3-6 meses cuando es más abundante, o para ambientes en que se den las siguientes condiciones:

- atmósferas marinas
- ambientes repletos de contaminantes industriales
- sal pulverizada proveniente de la sal utilizada en carreteras
- suciedad atmosférica y del tráfico

No deben usarse limpiadores que contengan cloruros ni lejías. Encontrará información más detallada en: www.leds-c4.com

CLEANING AND MAINTENANCE OF STAINLESS STEEL

Stainless steel is a highly resistant beautiful material being easy to conserve. However, it does require maintenance. For this reason, it is necessary to follow some minimum recommendations during its storage, manipulation and use. Correct cleaning preserves its original characteristics, especially its resistance to corrosion.

During cleaning it is important to clean the contaminating agents which are present in the atmosphere. This is particularly the case in industrial places or close to a marine environment, as these areas can cause localized corrosion if they are not efficiently eliminated.

A damp cloth or chamois leather cloth should be used to eliminate the dirt on the surface. In case of extra dirt, gentle detergents suitable for domestic use should be used with non abrasive scrubbers or nylon brushes (no metal scrubbers). After cleaning wipe away the residue with water and dry surface.

The recommended frequency is every 6-12 months for moderate dirt and 3-6 months for heavy dirt or for the following situation:

- Marine atmosphere
- Industrial contaminated areas
- Salt from road gritting
- Dirt from traffic

No cleaning agents that contain chloride or bleach should be used. You can find further information at: www.leds-c4.com

NETTOYAGE ET ENTRETIEN DE L'ACIER INOXYDABLE

Pour son excellente résistance et beauté, l'acier inoxydable est un matériel de conservation facile, en ayant souvent l'idée qu'il ne requiert pas d'entretien. Mais il est désormais nécessaire de suivre des recommandations minimales pendant son emmagasinage, manipulation et usage. Un nettoyage adéquat permet de maintenir ses caractéristiques originales inchangées, en préservant sa résistance à la corrosion et son apparence.

Pendant les tâches de nettoyage, il faut s'assurer de l'élimination des accumulations des contaminants portés pour l'air. Cela devient très important dans des milieux industriels ou marins parce qu'ils peuvent occasionner une corrosion focalisée s'ils ne s'enlèvent pas de façon efficiente.

Pour éliminer les salissures des surfaces, il faut utiliser un torchon humide ou un chamois. Pour des saletés plus tenaces, il faut utiliser des détergents doux à usage ménager avec des éponges ou des brosses douces en nylon (ne pas utiliser des brosses en fils d'acier). Après le nettoyage, éliminez les résidus avec de l'eau déminéralisée et séchez la surface.

Il est conseillé une périodicité des nettoyages tous les 6 à 12 mois dans tous les cas modérés et tous les 3 à 6 mois en cas de fortes salissures ainsi que dans les circonstances suivantes :

- milieu marin
- milieu industriel
- projections de sel d'épandage
- patine provoquée par la saleté de l'air et le trafic

On ne doit jamais utiliser des nettoyeurs contenant des chlorures ou des lessives. Vous trouverez information plus précise dans le site : www.leds-c4.com

REINIGUNG UND INSTANDHALTUNG VON ROSTFREIEM STAHL

Aufgrund seiner hohen Beständigkeit und seines attraktiven Erscheinungsbildes ist rostfreier Stahl ein einfach instand zu haltendes Material. Viele neigen daher zur irrftirlichen Annahme, dass rostfreier Stahl keine Wartung benötigt. Nichtsdestoweniger sollte man sich bei seiner Lagerung, Handhabung und seinem Gebrauch an gewisse Mindestanweisungen halten. Eine angemessene Reinigung trägt dazu bei, seine Eigenschaften im ursprünglichen Zustand zu erhalten, seine Korrosionsbeständigkeit zu erhöhen und sein attraktives Aussehen zu bewahren.

Während der Reinigung sollte man darauf achten, dass alle verunreinigenden Stoffe, die durch die Luft auf das Metall übertragen wurden, vollkommen entfernt werden. Dies ist besonders in den Bereichen der Industrie und der Seefahrt wichtig, denn werden diese Stoffe nicht auf wirksame Weise entfernt, so können sie an bestimmten Stellen Korrosionserscheinungen hervorrufen.

Für die Entfernung der Verunreinigungen von der Oberfläche ist ein feuchtes Tuch oder ein Wischlappen zu benutzen. Bei hartnäckigem Schmutz können milde Haushaltsreiniger mit weichen Scheuerlappen oder Nylonbürsten (keine Scheuerschwämme aus Stahl verwenden) eingesetzt werden. Danach müssen die Rückstände des Reinigers mit entionisiertem Wasser abgespült und die Oberfläche abgetrocknet werden.

Eine regelmäßige Reinigung sollte bei mässigem Schmutzbefall alle 6-12 Monate durchgeführt werden, bzw. alle 3-6 Monate bei stärkerem Schmutzbefall oder bei Vorliegen der folgenden Bedingungen:

- im Meerwasserbereich
- in Bereichen mit starker industriell bedingter Verschmutzung
- bei Einwirkung von Streusalz, das auf den Straßen eingesetzt wird
- wetter- oder verkehrsbedingter Schmutzbefall

Es dürfen keine Reiniger benutzt werden, die Chloride oder Laugen enthalten. Ausführlichere Information finden Sie in: www.leds-c4.com

PULIZIA E MANTENIMENTO DELL'ACCIAIO INOSSIDABILE

Per sua particolare resistenza e bellezza, l'acciaio inossidabile è un materiale di facile conservazione, è però necessaria una po' di manutenzione.

E' necessario seguire qualche raccomandazione durante l'immagazzinamento, manipolazione ed uso. La pulizia appropriata permette di conservare la sua caratteristica originale, non solo la resistenza alla corrosione ed il suo aspetto.

Durante la pulizia, bisogna assicurarsi che gli accumuli di sostanze contaminanti portate dall'aria siano rimossi. Ciò è particolarmente importante in ambienti marini ed industriali, questi possono dar luogo a corrosione localizzata, se non rimossi.

Per rimuovere uno sporco leggero o le impronte, è consigliabile usare un panno umido o di pelle scamosciata. Invece per lo sporco più consistente è consigliabile usare dei prodotti di uso domestico, spugnette oppure spazzole soffici (assolutamente non usare pagliette abrasive o metalliche). Dopo aver effettuato un'appropriata pulizia, rimuovere i residui con acqua preferibilmente deionizzata ed asciugare.

Si consiglia una pulizia ogni 6-12 mesi per uno sporco leggero, ed ogni 3-6 mesi per quello più pesante derivante dagli ambienti sotto citati:

- atmosfere marine
- ambienti carichi di prodotti industriali inquinanti
- spruzzi di acqua contenenti il sale antighiaccio sparso sulle strade
- inquinamento atmosferico e da traffico

Non devono essere usati dei prodotti contenenti cloruri e neanche candeggine a base di acido ipoclorico.

Troverete informazioni più specifiche sul sito: www.leds-c4.com

LIMPEZA E MANUTENÇÃO DO AÇO INOXIDÁVEL



















Dada a sua excelente resistência e beleza, o aço inoxidável é um material de conservação fácil, tendendo-se por vezes a ficar com a ideia de que não necessita de manutenção. No entanto é necessário que se sigam recomendações mínimas durante o seu armazenamento, manuseamento e uso. Uma limpeza adequada permite que se mantenham inalteradas as suas características originais, preservando a sua resistência à corrosão e o seu aspecto. Durante as tarefas de limpeza, certifique-se de que são eliminadas as acumulções de contaminantes transportados pelo ar. Isto é muito importante em locais industriais ou marítimos, dado que tais contaminantes podem provocar corrosão localizada se não forem eficazmente eliminados.



















Para eliminar a sujidade existente à sua superfície, deve-se utilizar um pano húmido ou uma camurça. No caso de sujidade mais difícil, devem ser utilizados detergentes suaves de uso doméstico, com esfregões ou escovas suaves de nylon (não se devem usar esfregões de aço). Depois da limpeza, devem ser eliminados os resíduos com água desionizada e secar a superfície.

Para uma limpeza regular, a frequência é de 6-12 meses para sujidade moderada e de 3-6 meses para sujidade mais abundante, ou para ambientes em que se verifiquem as condições seguintes:

- atmósferas marinhas
- ambientes repletos de contaminantes industriais
- sal pulverizado proveniente do sal utilizado nas estradas
- sujidade atmosférica e do trânsito

Não se devem usar produtos de limpeza que contenham cloratos ou lixívia. Pode encontrar informações mais detalhadas em: www.leds-c4.com

Lámpara Lamp	Fuentes de luz Light sources	Potencia Power	Voltage(V) Voltage (V)	Portalámparas Lampholder	Lumens (Lm) Candelas (Cd)	lcos
Incandescencia / Incandescence						
		40	230	E-14	400	IPP
		60	230	E-14	660	IPP
		40	230	E-27	430	IAA
		60	230	E-27	730	IAA
		75	230	E-27	960	IAA
		100	230	E-27	1380	IAA
PAR38		60	230	E-27	1200	HRG
		80	230	E-27	1800	HRG
		120	230	E-27	3100	HRG
Halógenas / Halogen						
QT32		60	230	E-27	490	HSGST
		100	230	E-27	1400	HSGST
HAL		150	230	E-27	2550	HEGBT
		40	230	B15d(L.86)	2500	HSG
			230	B15d(L.86)	2500	HSG
	70	12	BA-15d	2600	HSG	
		25	230	G9	260	HDG
		40	230	G9	490	HDG
		60	230	G9	820	HDG
75		230	G9	1100	HDG	
QT-12		20	12	G4	320	HSG
QT-DE		60	230	R7s (74,9)	840	HDG
		100	230	R7s (74,9)	1600	HDG
		150	230	R7s (74,9)	2600	HDG
		100	230	R7s (114,2)	1600	HDG
		200	230	R7s (114,2)	3500	HDG
		300	230	R7s (114,2)	5300	HDG
PAR16		35	230	GU10	600	HAGS
		50	230	GU10	950	HAGS
		35	230	GZ10	600	HAGS
		50	230	GZ10	900	HAGS
PAR20		50	230	E-27	3200	HEGPAR
PAR30		75	230	E-27	6900	HEGPAR
		75	230	E-27	2200	HEGPAR
		100	230	E-27	9000	HEGPAR
QR-111		75	12	G53	30000	HRGI
		100	12	G53	48000	HRGI
QR-CB		20	12	GU-4	4500	HRGI
		35	12	GU-5,3	3750	HRGI
		50	12	GU-5,3	15000	HRGI
		50	12	GU-5,3	2850	HRGI
QR-70		50	12	BA-15d	-	-
Vapor Sodio / Sodium vapour lamp						
HST		50	230	E-27	3500	SE
		70	230	E-27	5600	SE
		100	230	E-27	10200	SE
		250	230	E-27	27000	SE
		400	230	E-27	48000	SE
Vapor Mercurio / Mercury vapour lamp						
HME		50	230	E-27	2000	QE
		80	230	E-27	4000	QE
		125	230	E-27	6500	QE
Luz Mezcla / Mixed light						
Mezcla / Mixed		160	230	E-27	3100	QB

Lámpara Lamp	Fuentes de luz Light sources	Potencia Power	Voltage(V)	Portalámparas Lampholder	Lumens (Lm) Candelas (Cd)	Ilcos
Fluorescencia / Fluorescence						
COMPACTAS / COMPACT		5	230	E-27	240	FBT
		7	230	E-27	400	FBT
		11	230	E-27	630	FBT
		15	230	E-27	900	FBT
		20	230	E-27	1200	FBT
		23	230	E-27	1500	FBT
30	230	E-27	1900	FBT		
PAR 30		15	230	E-27	190 (cd)	-
PAR 38		15	230	E-27	190 (cd)	-
		20	230	E-27	295 (cd)	-
		23	230	E-27	339 (cd)	-
TC		7	230	G23	400	FSD
		9	230	G23	600	FSD
		11	230	G23	900	FSD
TC-D		10	230	G24d1	600	FSQ
		13	230	G24d1	900	FSD
		18	230	G24d2	1200	FSD
		26	230	G24d3	1800	FSD
TC-DE		18	230	G24q2	1200	-
		26	230	G24q3	1800	-
TC-T		18	230	Gx24d2	1200	FSM
		26	230	Gx24d3	1800	FSM
TC-TE		26	230	Gx24q3	1800	FSMH
		42	230	Gx24q4	3200	FSMH
		57	230	Gx24q5	4300	FSMH
		70	230	Gx24q6	5200	FSMH
TC-L		24	230	2G11	1800	FSD
		55	230	2G11	4800	FSD
		80	230	2G11	600	FSD
T1		7	230	GU10	62 (cd)	-
		9	230	GU10	92 (cd)	-
		11	230	GU10	110 (cd)	-
T2		9	230	Gx53	265 (cd)	-
T5		8	230	G5	300	FD
		21	230	G5	1900	FD
		28	230	G5	2600	FD
		35	230	G5	3300	FD
		24	230	G5	1750	FD
		39	230	G5	3100	FD
		49	230	G5	4300	FD
		54	230	G5	4450	FD
T8		18	230	G3	1350	FD
		36	230	G13	3250	FD
		58	230	G13	5200	FD
Halogenuros Metálicos / Metal Halogen						
CDM-R111		70	230	Gx8,5	50000	MR
CDM-R (H.I.D.)		35	230	E-27	46000	MR
		70	230	E-27	70000	MR
HIE		35	230	E-27	24000	MR
		70	230	E-27	6000	MC
		250	230	E-40	20000	MC
HIT		400	230	E-40	35000	MC
		35	230	G12	3300	MT
		70	230	G12	5500	MT
HIT-DE		150	230	G12	13000	MT
		70	230	Rx7s	6500	MD
		150	230	Rx7s	14500	MD
CDM-Tm		250	230	Fc2	24500	MD
		20	230	PGJS	1650	MT

INDICE / INDEX

278

00-8715-05-37	233	05-9182-34-B8	19	05-9346-34-B8	21
00-8958-18-37	213	05-9190-34-37	165	05-9346-Z5-B8	21
00-9100-18-37	217	05-9191-34-37	165	05-9347-34-B8	21
00-9126-18-AA	205	05-9195-18-T2	169	05-9347-Z5-B8	21
00-9132-18-AA	213	05-9195-34-T2	169	05-9350-18-AA	191
00-9149-18-AA	209	05-9202-18-AA	207	05-9351-18-AA	191
00-9151-18-E7	229	05-9204-34-B8	49	05-9356-05-B8	197
00-9175-18-AA	219	05-9204-Z5-B8	49	05-9359-34-T2	69
00-9202-18-AA	207	05-9207-J6-M1	39	05-9360-34-T2	69
00-9295-18-M3	195	05-9207-Y4-M1	39	05-9368-34-37	49
00-9298-Z5-M3	179	05-9208-34-37	57	05-9368-Z5-37	49
00-9312-18-AA	202	05-9208-Z5-37	57	05-9369-34-37	49
00-9350-18-AA	191	05-9211-Y4-T2	23	05-9369-Z5-37	49
00-9389-18-AA	201	05-9212-Y4-T2	23	05-9370-34-T2	163
00-9447-18-M3	187	05-9227-34-37	51	05-9371-34-T2	163
05-8715-05-37	233	05-9227-Z5-37	51	05-9372-AW-M3	37
05-8726-18-37	222	05-9228-34-37	51	05-9373-J6-M3	37
05-8729-05-M3	42	05-9228-Z5-37	51	05-9379-18-T2	227
05-8729-14-M3	42	05-9229-34-37	51	05-9388-34-T2	19
05-8729-34-M3	42	05-9229-J6-37	51	05-9388-Z5-T2	19
05-8751-05-M3	42	05-9229-Z5-37	51	05-9389-18-AA	201
05-8751-14-M3	42	05-9230-34-37	51	05-9390-Z5-M3	179
05-8751-34-M3	42	05-9230-J6-37	51	05-9393-34-37	53
05-8759-05-B8	23	05-9230-Z5-37	51	05-9393-Z5-37	53
05-8759-14-B8	23	05-9234-18-37	159	05-9407-34-B8	17
05-8759-34-B8	23	05-9234-34-37	159	05-9408-34-M3	31
05-8761-18-37	225	05-9235-18-37	159	05-9408-Z5-M3	31
05-8762-18-37	225	05-9235-34-37	159	05-9409-34-M3	35
05-8767-34-M3	44	05-9236-J6-M1	39	05-9409-Z5-M3	35
05-8783-05-M3	45	05-9236-Y4-M1	39	05-9410-Z5-B8	29
05-8783-14-M3	45	05-9238-34-M3	173	05-9415-Z5-M3	35
05-8788-Y4-M3	147	05-9239-Y4-M2	145	05-9416-34-37	65
05-8790-Y4-M1	141	05-9240-34-37	17	05-9416-Z5-37	65
05-8796-Y4-M1	146	05-9241-34-37	77	05-9417-34-T2	69
05-8938-18-37	220	05-9245-Y4-37	109	05-9434-34-T2	19
05-8940-18-37	215	05-9249-18-AA	227	05-9438-34-37	51
05-8959-05-37	223	05-9250-34-37	81	05-9438-Z5-37	51
05-8961-05-B8	23	05-9251-34-37	81	05-9439-Z5-37	85
05-8961-14-B8	23	05-9252-34-37	81	05-9444-Z5-M3	27
05-8961-34-B8	23	05-9253-34-37	81	05-9447-18-M3	187
05-8962-18-37	222	05-9254-34-37	81	10-8715-05-37	233
05-8965-18-M3	227	05-9258-14-B8	220	10-8790-Y4-M1	141
05-9100-18-37	215	05-9261-18-AA	207	10-9100-18-37	217
05-9103-05-37	237	05-9264-Z5-37	85	10-9116-Z5-M2	120
05-9104-18-M2	221	05-9265-Z5-37	85	10-9126-18-AA	205
05-9107-34-37	72	05-9266-Z5-37	85	10-9132-18-AA	214
05-9107-Z5-37	72	05-9268-34-M2	76	10-9149-18-AA	210
05-9114-Z5-B8	153	05-9287-34-37	53	10-9151-18-E7	229
05-9121-Y4-B8	149	05-9287-Z5-37	53	10-9152-18-E7	231
05-9122-Y4-37	72	05-9288-J6-M1	39	10-9176-92-B8	175
05-9123-34-B8	55	05-9288-Y4-M1	39	10-9183-18-B8	134
05-9123-Z5-B8	55	05-9295-18-M3	195	10-9195-18-T2	169
05-9124-18-37	203	05-9296-34-37	71	10-9195-34-T2	169
05-9126-18-AA	205	05-9296-Z5-37	71	10-9202-18-AA	207
05-9128-34-T2	17	05-9297-34-37	71	10-9237-Z5-M2	136
05-9129-34-37	57	05-9297-Z5-37	71	10-9295-18-M3	195
05-9129-Z5-37	57	05-9298-Z5-M3	179	10-9298-Z5-M3	183
05-9131-34-M3	43	05-9299-Z5-M3	179	10-9299-Z5-M3	181
05-9131-Z5-M3	43	05-9300-34-M3	41	10-9329-18-B8	171
05-9132-18-AA	213	05-9300-Z5-M3	41	10-9329-34-B8	171
05-9146-34-T2	76	05-9301-34-M3	41	10-9333-J6-M1	143
05-9149-18-AA	209	05-9301-Z5-M3	41	10-9350-18-AA	193
05-9150-18-AA	211	05-9308-18-B8	157	10-9356-05-B8	197
05-9151-18-E7	229	05-9308-34-B8	157	10-9386-34-M3	119
05-9152-18-E7	231	05-9309-34-37	157	10-9386-K7-M3	119
05-9158-18-AA	224	05-9310-Y4-37	73	10-9386-Z5-M3	119
05-9159-34-37	57	05-9312-18-AA	202	10-9387-34-M3	119
05-9159-Z5-37	57	05-9313-18-AA	202	10-9387-K7-M3	119
05-9165-05-37	73	05-9315-34-B8	19	10-9387-Z5-M3	119
05-9165-34-37	73	05-9315-Z5-B8	19	10-9389-18-AA	201
05-9167-34-37	17	05-9327-34-37	71	10-9390-Z5-M3	181
05-9169-34-37	17	05-9327-Z5-37	71	10-9432-34-B8	219
05-9173-34-T2	76	05-9329-18-B8	169	10-9432-J6-B8	219
05-9175-18-AA	219	05-9329-34-B8	169	10-9447-18-M3	187
05-9176-92-B8	175	05-9330-05-B8	199	15-8797-Y4-F9	148
05-9177-34-B8	55	05-9331-05-B8	199	15-9102-18-B8	154
05-9177-J6-B8	55	05-9333-J6-M1	143	15-9114-Z5-B8	152
05-9177-Z5-B8	55	05-9344-J6-T2	13	15-9119-Z5-M3	151
05-9179-34-B8	19	05-9344-Y4-T2	13	15-9153-Z5-B8	150
05-9179-Z5-B8	19	05-9345-J6-T2	13	15-9209-18-M3	154
05-9180-18-AA	209	05-9345-Y4-T2	13	15-9234-18-37	159

15-9234-34-37	159	55-9305-48-48	82,246,249	71-9198-05-05	258
15-9298-Z5-M3	181	55-9317-Y4-M2	145	71-9199-05-05	258
15-9300-34-M3	41	55-9318-34-M3	133	71-9206-05-05	259
15-9300-Z5-M3	41	55-9318-J6-M3	133	71-9262-05-05	258
15-9328-34-B8	53	55-9318-Z5-M3	133	71-9273-05-05	259
15-9328-Z5-B8	53	55-9319-34-M3	133	71-9278-05-05	258
15-9340-92-B8	155	55-9319-J6-M3	133	71-9291-34-34	82
15-9341-92-M2	155	55-9319-Z5-M3	133	71-9292-34-34	82
15-9350-18-AA	193	55-9320-34-M3	133	71-9311-05-05	258
15-9362-34-37	61	55-9320-J6-M3	133	71-9332-00-00	241
15-9362-Z5-37	61	55-9320-Z5-M3	133	71-9396-05-05	259
15-9363-34-37	61	55-9323-Y4-37	94	71-9397-05-05	259
15-9363-Z5-37	61	55-9329-18-B8	171	71-9398-05-05	246
15-9364-34-37	61	55-9329-34-B8	171	71-9399-05-05	246
15-9364-Z5-37	61	55-9332-M1-M1	241	71-9400-34-34	258
15-9365-34-T2	61	55-9333-J6-M1	143	71-9403-34-34	243
15-9365-Z5-T2	61	55-9334-34-M3	131	71-9404-34-34	243
15-9370-34-T2	163	55-9334-Z5-M3	131	71-9405-M3-M3	259
15-9381-Y4-37	91	55-9335-34-M3	131	71-9406-M3-M3	259
15-9391-Y4-B8	91	55-9335-Z5-M3	131	71-9442-00-00	246
15-9392-Y4-B8	91	55-9336-34-M3	131	71-9445-Z5-Z5	27
55-8766-05-05	235,237	55-9336-Z5-M3	131	71-9448-Y4-Y4	91,97,98,101
55-8784-05-05	75	55-9337-Y4-37	95	71-9449-Y4-Y4	97,98
55-8785-05-05	75	55-9342-34-M3	133	71-9450-Y4-Y4	98
55-8790-Y4-M1	141	55-9342-J6-M3	133	71-9451-Y4-Y4	101
55-8791-Y4-Y4	141	55-9342-Z5-M3	133	71-9452-Y4-Y4	95,99
55-8793-05-05	235,237	55-9343-34-M3	133	71-9453-Y4-Y4	93,94
55-8956-05-M1	134	55-9343-J6-M3	133	71-9454-Y4-Y4	95
55-8956-34-M1	134	55-9343-Z5-M3	133	80-3003-BP-37	256
55-9125-Z5-M2	137	55-9349-Z5-M3	75	80-3006-BP-37	256
55-9128-34-T2	135	55-9350-18-AA	193	80-3009-BP-37	256
55-9132-18-AA	214	55-9354-Y4-37	107	80-3014-BP-37	256
55-9149-18-AA	210	55-9355-Y4-37	107	80-3017-BP-37	256
55-9151-18-18	231	55-9357-34-M3	127	80-3020-BP-37	256
55-9155-Y4-M1	242	55-9357-Z5-M3	127	80-3027-BP-37	256
55-9156-Y4-M1	242	55-9358-34-M3	127	80-3028-BP-37	256
55-9172-34-37	75	55-9358-Z5-M3	127	80-3031-BQ-37	257
55-9176-92-B8	175	55-9361-34-T2	125	80-3034-BQ-37	257
55-9184-Y4-37	98	55-9371-34-T2	163	80-3041-BQ-37	257
55-9186-Y4-37	99	55-9374-34-T2	125	80-3046-BS-37	256
55-9187-Y4-37	94	55-9377-Y4-37	107	80-3049-BS-37	256
55-9190-34-37	165	55-9378-Y4-37	107	80-3056-BS-37	256
55-9191-34-37	165	55-9380-Y4-37	97	80-3059-BS-37	256
55-9195-18-T2	171	55-9382-Y4-37	101	80-3073-AT-37	255
55-9195-34-T2	171	55-9384-Y4-37	95	80-3076-AT-37	255
55-9203-18-18	207	55-9390-Z5-M3	183	80-3085-AT-37	255
55-9216-B8-B8	239	55-9394-Y4-37	97	80-3089-AT-37	255
55-9232-Y4-37	93	55-9421-M3-M3	113	80-3093-AT-37	255
55-9233-Y4-37	93	55-9423-34-T2	115	80-3097-AT-37	255
55-9237-Z5-M2	136	55-9423-Z5-T2	115	80-3153-BK-H6	254
55-9238-34-M3	173	55-9424-34-T2	115	80-3159-BK-H6	254
55-9239-Y4-M2	145	55-9424-Z5-T2	115	80-3163-BK-H6	254
55-9242-54-B8	103	55-9425-M3-M3	113	80-3167-BK-H6	254
55-9243-54-B8	103	55-9427-34-T2	115	80-3171-BK-H6	254
55-9244-B8-B8	239	55-9427-Z5-T2	115	80-3175-BP-37	256
55-9245-Y4-37	109	55-9428-34-T2	115	80-3178-BP-37	256
55-9246-B8-B8	239	55-9428-Z5-T2	115	80-3181-BP-37	256
55-9250-34-37	83	55-9429-Y4-37	93	80-3195-BK-H6	254
55-9251-34-37	83	55-9430-Y4-T2	95	80-3199-B0-H6	254
55-9254-54-37	102	55-9431-34-M2	253	80-4447-B0-H6	254
55-9255-54-37	102	55-9433-Y4-37	93	80-4452-B0-H6	254
55-9257-54-M2	102	55-9435-Y4-37	101	80-4457-B0-H6	254
55-9263-Y4-37	121	55-9437-Y4-37	101	80-4462-B0-H6	254
55-9264-Y4-37	89	55-9440-Y4-M2	145	80-4467-B0-H6	254
55-9265-Y4-37	89	55-9443-Y4-37	101	80-4472-PB-37	255
55-9266-Y4-37	89	60-8772-05-37	235	80-4475-BP-37	255
55-9268-34-M2	253	60-9103-05-37	237	80-4478-BP-37	255
55-9269-34-M2	253	60-9151-18-E7	231	80-4484-BP-37	255
55-9272-Z5-M2	136	60-9152-18-E7	231	80-4487-BP-37	255
55-9280-Y4-37	97	60-9203-18-AA	207	80-4492-BP-37	255
55-9281-Y4-37	97	60-9293-34-M2	252	83-3023-AX-37	257
55-9282-Y4-T2	98	60-9294-34-M2	252	83-3024-AX-37	257
55-9283-Y4-T2	98	60-9306-Z5-M3	247	83-3025-AX-37	257
55-9284-37-37	99	60-9307-Z5-M3	247	83-3102-BB-M2	255
55-9293-34-34	252	60-9375-Z5-M3	247	83-3105-BB-M2	255
55-9294-34-34	252	60-9376-Z5-M3	247	83-3119-BB-M2	255
55-9295-18-M3	195	60-9441-05-M2	249	83-3186-BB-M2	255
55-9298-Z5-M3	183	71-8949-05-M2	259	83-4488-AX-37	257
55-9302-B8-B8	239	71-8969-00-00	259	83-4489-AX-37	257
55-9303-B8-B8	239	71-9187-Y4-37	94	83-4490-AX-37	257
55-9304-B8-B8	239	71-9197-05-05	258	83-4491-AX-37	257



EMBLAJE FUNCIONAL / FUNCTIONAL PACKAGING



DISPLAY PARA MINI CATÁLOGOS / MINI CATALOGUES DISPLAY



LEDS-C4, S.A.
Afueras s/n, - 25750 - TORA (Lleida) SPAIN
www.leds-c4.com

España

Tel.: 973 46 81 01
Fax.: 973 46 81 29
info@leds-c4.com

Europe

Tel.: + 34 973 46 81 02
Fax.: + 34 973 46 81 06
europa@leds-c4.com

France - Portugal

Tel.: + 34 973 46 81 30
Fax.: + 34 973 46 81 29
france@leds-c4.com
portugal@leds-c4.com

Asia - Pacific and Africa

Tel.: + 34 973 46 81 16
Fax.: + 34 973 46 81 06
export@leds-c4.com

USA - Canada - Ireland

Tel.: +34 973 46 81 09
Fax: +34 973 46 81 06
lighting@leds-c4.com

América Latina

Tel.: + 34 973 46 81 15
Fax.: + 34 973 46 81 06
sudamerica@leds-c4.com

Middle East Countries

Tel.: + 34 973 46 81 08
Fax.: + 34 973 46 81 06
dep-export@leds-c4.com

